

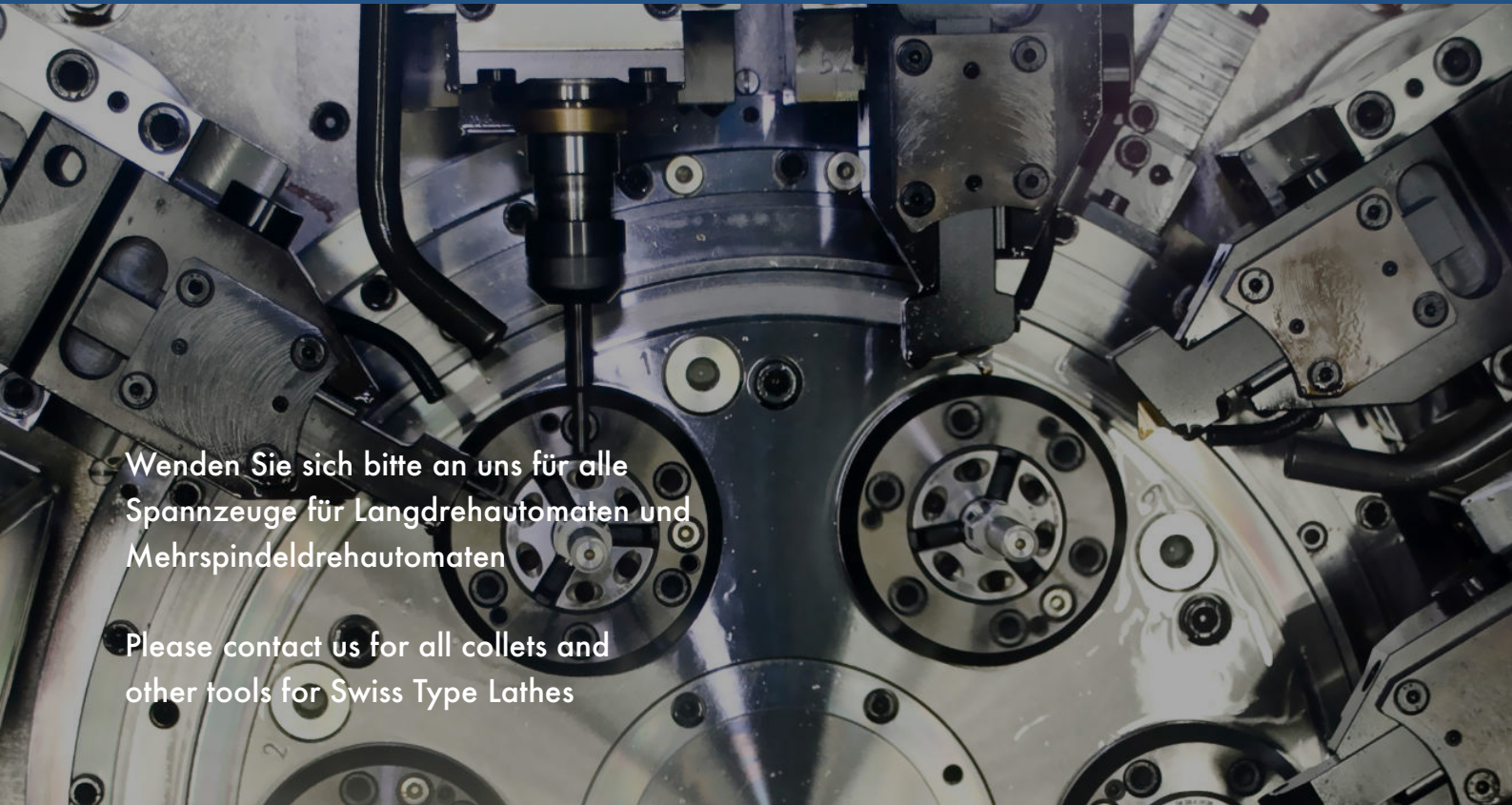

Spannzeuge für Langdrehautomaten

Tools for Swiss Type Lathes



Wenden Sie sich bitte an uns für alle
Spannzeuge für Langdrehautomaten und
Mehrspindeldrehautomaten

Please contact us for all collets and
other tools for Swiss Type Lathes

stair

CITIZEN

TSUGAMI

TORNOS

**INDEX
TRAUB**

DMG MORI

Miyano

MAIER
MACHINES & ROBOTICS

 Hanwha

NEXTURN
SWISS TURN LEADER

NOMURADS

WOODWAY
THE ULTIMATE MACHINING POWER

DOOSAN

 **VAN**
Precision Engineering

ergomat

Druckspannzangen
Dead Length Collets

2



Druckspannzangen mit Vorbau
Dead Length Collets with Extended Nose

5



Druckspannzangen mit HM-Einsatz
Dead Length Collets with Carbide Insert

7



Führungsbuchsen
Guide Bush (with Carbide Insert)

8



Kroko-Spannzangen
Kroko Collets

10



Wifex Innenspannung
Wifex for Internal Clamping

11



Spannzangentypen
Collet Type

13

STAR / HANWHA
DMG / CITIZEN
NEXTURN / TRAUB
TORNOS / TSUGAMI



Spannhülse für Lademagazine
Bar Feed Collet for Bar Loaders

18



Spannhülsenlagerung für Lademagazine
Revolving end for Bar Feeders

21



Spannfinger für Drehautomaten
Toggles

24



Spannzangenfutter mit Zylinderschaft
Collet Chuck with Cylindrical Shank

30



Räumwerkzeuge
Broaching Tools

33



Spannzangen Für Mehrspindeldrehautomaten
Collets for Multi-Spindle Automatic Lathes

38



Zugspannzangen
Drawback Collets

42



ER Spannzangen DIN 6499
ER Collet DIN 6499

44



Spannmutter ER DIN 6499
Clamping Nut ER DIN 6499

50



Angetriebene Werkzeuge
Driven Tools



57

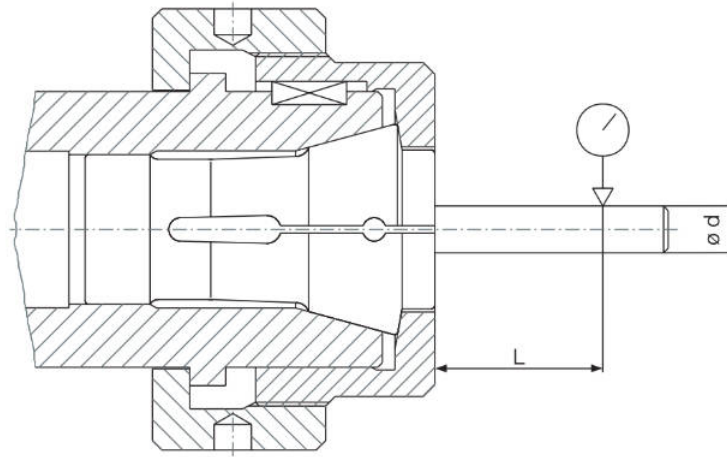



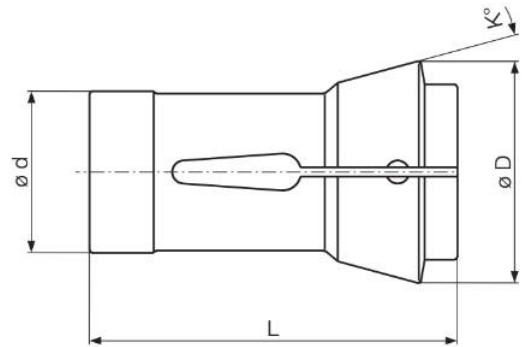

Spanndurchmesser \varnothing Bore \varnothing	Prüflänge Testing Length	Rundlaufgenauigkeit Concentricity	
	L	Standard	Genauigkeitsausführung High Precision
1 - 1,6	6	0,02	0,01
1,6 - 3	10	0,02	0,01
3 - 6	16	0,02	0,01
6 - 10	25	0,02	0,01
10 - 18	40	0,03	0,015
18 - 24	50	0,03	0,015
24 - 30	60	0,03	0,015
30 - 50	80	0,04	0,02
50 - 60	10	0,04	0,02



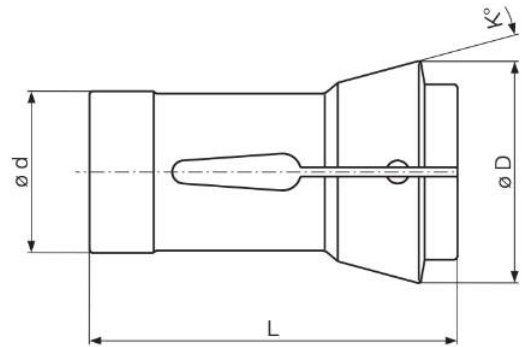

Art.-Nr.	Spannzangentyp Collet Type	$\varnothing d$	$\varnothing D$	L	K°	Maximale Bohrung Maximum Bore		
						\varnothing		
100 E	F6 76-599	6	10	30	15°	4,5	-	-
1010 E	F7 76-576	7	11	41	15°	5	-	-
1020 E	F7 76-66	7	10,7	26	15°	5,5	-	-
101 E	F8 76-577	8	12	42	16°	6,35	-	-
102 E		8	13,7	30	21°	6	-	-
103 E		8	14	35	15°	5	-	-
109 E	F10 76-86	10	15,5	47,5	20°	8	7	5,5
110 E	F10 76-720	10	16	43	15°	8	-	-
111 E	F10 76-1178	10	16	46	20°	8	-	-
112 E		11	18,7	41	22°	8	-	-
113 E	F12 76-1354	12	15,5	30,5	10°	10	-	-
114 E	F12 76-578	12	18	64	16°	10	-	-
1155 E	F12 76-78	12	18,1	44,5	15°	10	-	-
116 E	F13 76-357	13	19	64	16°	10	8	7
117 E	F14 76-98	14	18	46	13°	12	10	8
118 E		14	19,5	46	15°	10,5		
120 E	F15 76-580	15	21	64	16°	13	11	9
121 E	F15 76-358	15	22	47	20°	-	-	-
123 E	F16 76-104	16	22	55	15°	-	-	-
1212E	F16 76-1076	16	21	64	16°	13	10	8
125 E		17,5	22	51	15°	-	-	-
127 E	F18 76-85	18	25	67	15°	-	-	-

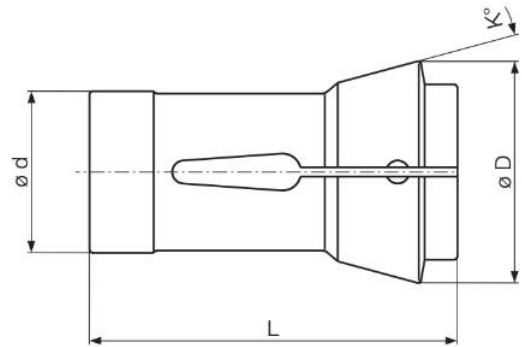

Art.-Nr.	Spannzangentyp Collet Type	$\varnothing d$	$\varnothing D$	L	K°	Maximale Bohrung Maximum Bore		
						\varnothing		
128 E	F18 76-579	18	24	64	16°	-	-	-
136 E	F20 76-201	20	26	54	15°	16	14	10
1299 E	F20 76-02	20	27,5	60	15°	-	-	-
137 E		20	27,5	69	15°	-	-	-
138 E	F20 76-87	20	28	67	16°	16	14	11
139 E	F22 76-88	22	28	67	13°	-	-	-
140 E	F22 76-71	22	30	55	15°	16	15	10
143 E	F25 76-581	25	31	54	15°	20	14	14
144 E	F25 76-91	25	34	65	15°	20	17	14
145 E	F25 76-64	25	35	77	16°	21	17	14
146 E	F26 76-90	26	32	67	13°	20	17	14
147 E	F27 76-22	27	38	72,7	15°	23	20	16
148 E	F28 76-93	28	38	70	15°	24	19	16
156 E		30	39,3	86,5	15°	-	-	-
157 E	F30 76-63	30	42	80	16°	26	22	18
F30 / 1446E	F30 76-101	30	38	65	15°	26	22	17
161 E	F32 76-221	32	45	75	15°	28	24	19
165 E / 1497E	F34 76-77	34	44	80	16°	-	-	-
162 E	F35-76-67	35	43	70	15°	30	24	20



Art.-Nr.	Spannzangentyp Collet Type	$\varnothing d$	$\varnothing D$	L	K°	Maximale Bohrung Maximum Bore		
						\varnothing		
163 E	F35 76-94	35	48	80	15°	30	27	20
F37 / 1536E	F37 76-740	37	47	92	16°	32	27	22
164 E	F38 76-72	38,08	49	108	15°	32	27	22
171 E	F42 76-99	42	55	94	15°	37	32	26
173 E	F48 76-81	48	60	94	15°	42	38	30
177 E	F58 17-355	58	70	94	15°	52	44	36
185 E	F66 76-59	66	84	110	15°	60	50	41
187 E		72	90	142	15°	-	-	-
188 E		84	100	142	15°	-	-	-
190 E		88	106	115	15°	80	69	56
193 E		90	107	130	15°	-	-	-
194 E		95	116	200	15°	-	-	-
195 E		105	125	172	15°	-	-	-
196 E		112	138	120	15°	-	-	-



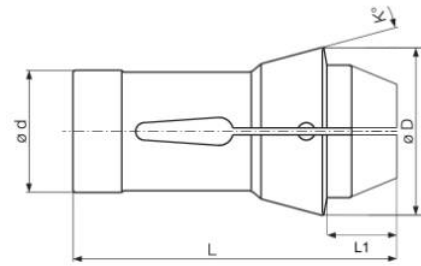

Art.-Nr.	Spannzangentyp Collet Type	$\varnothing d$	$\varnothing D$	L	L ₁	K°
116E-10	F13-58-10	13	19	68	10	16°
116E-12	F13-58-12	13	19	70	12	16°
120E-13	F15-58-13	15	21	71	13	16°
120E-15	F15-58-15	15	21	73	15	16°
120E-20	F15-58-20	15	21	78	20	16°
123E-20	F16-50-20	16	22	70	20	15°
1212E-8	F16-58-8	16	21	66	8	16°
1212E-13	F16-58-13	16	21	71	13	16°
1212E-15	F16-58-15	16	21	73	15	16°
1212E-20	F16-58-20	16	21	78	20	16°
136E-13	F20-49-13	20	26	62	13	15°
136E-15	F20-49-15	20	26	64	15	15°
136E-20	F20-49-20	20	26	69	20	15°
138E-15	F20-60-15	20	28	75	15	16°
138E-20	F20-60-20	20	28	80	20	16°
140E-15	F22-49-15	22	30	64	15	15°
140E-20	F22-49-20	22	30	69	20	15°
	F24-55-15	24	28	70	15	15°
	F24-55-20	24	28	75	20	15°
145E-18	F25-67-18	25	35	85	18	16°
145E-25	F25-67-25	25	35	92	25	16°

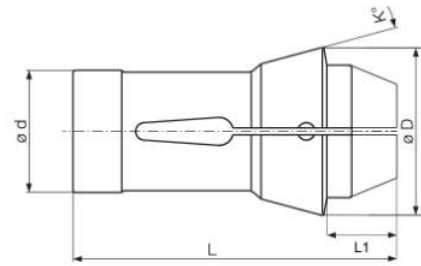

Art.-Nr.	Spannzangentyp Collet Type	$\varnothing d$	$\varnothing D$	L	L ₁	K°
147E-8	F27-65-8	27	38	73	8	15°
147E-18	F27-65-18	27	38	83	18	15°
147E-25	F27-65-25	27	38	90	25	15°
148E-20	F28-63-20	28	38	83	20	15°
148E-25	F28-63-25	28	38	88	25	15°
1446E-20	F30-59-20	30	38	79	20	15°
161E-15	F32-67-15	32	45	82	15	15°
161E-20	F32-67-20	32	45	87	20	15°
161E-25	F32-67-25	32	45	92	25	15°
162E-27	F35-63-27	35	43	90	27	15°
163E-28	F35-72-28	35	48	100	28	15°
1536E-20	F37-82-20	37	47	102	20	16°
1536E-25	F37-82-25	37	47	107	25	16°
1536E-30	F37-82-30	37	47	112	30	16°
171E-20	F42-85-20	42	55	105	20	15°
171E-25	F42-85-25	42	55	110	25	15°
173E-28	F48-85-28	48	60	113	28	15°



Druckspannzangen mit HM-Einsatz
Dead length collets with carbide insert



Druckspannzangen mit Vorbau und
HM-Einsatz
Dead length collets with extended
nose and HM insert

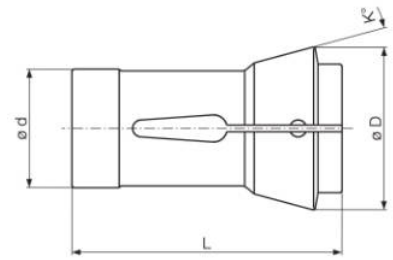

Art.-Nr.	Ø d	Ø D	L	K°	Maximale Größe Maximum Size Ø
101E HM	8	12	42	16°	4
109E HM	10	15,5	47,5	20°	5,5
111E HM	10	16	46	20°	7,0
116E HM	13	19	64	16°	7,0
117E HM	14	18	46	13°	8,0
118E HM	14	19,5	46	15°	8,0
120E HM	15	21	64	16°	9,0
F16-1212E HM	16	21	64	16°	11,0
138E HM	20	28	67	16°	15,0
145E HM	25	35	77	16°	20,0
157E HM	30	42	80	16°	24,0
F30 / 1446E HM	30	38	65	15°	24,0
161E HM	32	45	75	15°	25,0
163E HM	35	48	80	15°	29
F37 / 1536E HM	37	47	92	16°	31
164E HM	38,08	49	108	15°	29
171E HM	42	55	94	15°	34
173E HM	48	60	94	15°	39
185E HM	66	84	110	15°	60

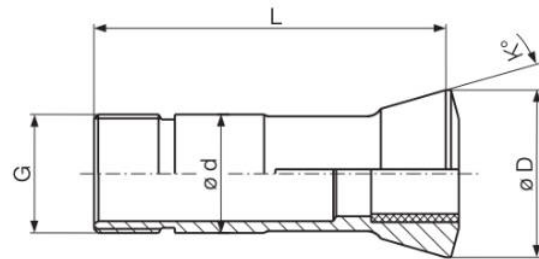

Art.-Nr.	Ød	ØD	Gewinde Thread G	L	K°	Maximale Bohrung Maximum Bore		
						Ø	⬡	□
F 351	9	12,3	M 8 x 0,6	50	30°	4,0	4,5	3,5
I 351	9	12,5	M 8 x 0,75	44	16°	4,0	4,5	3,5
F 352	11	15	M 10 x 0,6	50	30°	6,0	5,5	4,5
I 352	11	14,5	M 10 x 0,8	53	16°	6,5	5,5	4,5
F 3001	11	14,5	M 10 x 0,75	53	16°	6,5	6,0	4,5
I 353	16	20,5	M 14 x 1	59	16°	10,0	9,0	7,0
F 853	18	21,8	M 16 x 1	59	30°	12,0	10,5	8,5
F 104	20	25	M 20 x 1	55	30°	13,0	11,0	9,0
T 221	21	24	M 18 x 1	57,5	12°	14,0	12,0	9,5
I 354	22	29	M 19 x 1	68	16°	15,0	13,0	10,5
F 391	22	29	M 22 x 1	68	16°	16,0	14,5	12,0
F 605	24	29,5	M 24 x 1	61	30°	16,0	14,0	11,5
TD 26	26	29	M 25 x 1	77	16°	20,0	17,5	14,0
T 223	28	34	M 25 x 1	82	16°	20,0	17,0	14,0
T 223 S	28	34	M 27 x 1	82	16°	22,0	19,0	15,5
I 357	28	38	M 25 x 1	81	30°	20,0	17,0	14,0
F 355	32	39,8	M 32 x 1	71	30°	22,5	19,5	16,0
T 227	34	41	M 34 x 1	87,5	10°	27,5	24,0	19,5
T 229	42	49	M 40 x 1	82	16°	33,0	29,0	24,0
T 245	45	52	M 42 x 1	82	16°	37,0	32,0	26,0
T 246	46	53	M 45 x 1	92	16°	38,0	32,5	26,5
T 248	48	54	M 46 x 1	82	16°	38,0	33,0	27,0
T 249	48	54	M 46 x 1	81	10°	38,0	33,0	27,0

Andere Typen auf Anfrage / Other types available on request



Standardlänge aus Hartmetall
Standard Carbide Length

- ✓ Auf Anfrage mit langem Hartmetall gefertigt.
- ✓ 30-35-40 mm Hartmetall in voller Länge, der Rest ist Stahlverlängerung.



Hartmetalllänge in voller Länge
Full Length Carbide

- ✓ Long carbide upon request
- ✓ For the full length guiding carbide length 30-35-40mm, rest is steel extension



- ✓ WAVE Schlitze verhindern eine Verschmutzung der Führungsflächen
- ✓ Es können 6-kant- und 4-kant-Profile geführt werden
- ✓ Hohe Rundlaufgenauigkeit
- ✓ Durchmesser ab 2,00 mm.



- ✓ Prevents chips and dirt in the bores and slits
- ✓ Well-suited to drive square and hexagon material
- ✓ High runout accuracy
- ✓ Starting from 2 mm diameter

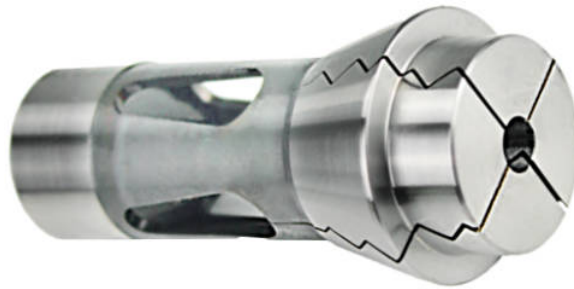

116 E / 120E / 1212E / 136E / 138E / 140E / 145E / 1446E (F30) / 1536E (F37)

- ✓ Hochpräzise Spannung mit Rundlaufgenauigkeit 0,005 mm
- ✓ Verhindert Riefenbildung
- ✓ Spannung von 6-kant oder 4-kant Profilen möglich
- ✓ Verhindert Späne und Schmutz in der Bohrung und in den Schlitzen
- ✓ Ideal zum Spannen von Medizinschrauben
- ✓ 0,005 High Runout accuracy
- ✓ Prevents chips and dirt into the bores and in the slots
- ✓ Clamping of square and hexagon profiles are possible
- ✓ Prevents scratches
- ✓ Ideal for clamping medical screws

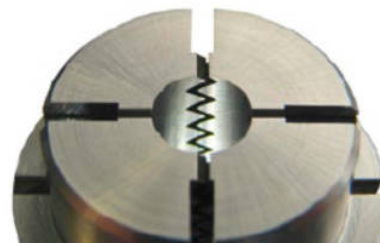
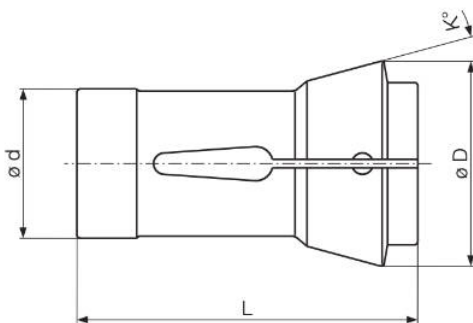

Art.-Nr.	Spannzangentyp Collet Type	$\varnothing d$	$\varnothing D$	L	K°	Maximale Bohrung Maximum Bore
KROKO 116E	F13 76-357	13	19	64	16°	10,0
KROKO 120E	F15 76-580	15	21	64	16°	13,0
KROKO 1212E	F16 76-1076	16	21	64	16°	13,0
KROKO 136E	F20 76-201	20	26	54	15°	16,0
KROKO 138E	F20 76-87	20	28	67	16°	16,0
KROKO 145E	F25 76-64	25	35	77	16°	21,0
KROKO 1446E	F30 76-101	30	38	65	15°	26,0
KROKO 1536E	F37 76-740	37	47	92	16°	32



F20 /136E - F20/138E - F25/145E - F37/1536E - F42/171E - F48/173E

- ☑ Innenspannung
- ☑ F20, F25, F37, F42, F48 Optionen sind verfügbar.
- ☑ Spannkapazität ab 1,5 mm
- ☑ Nach der technischen Zeichnung des zu spannenden Teils hergestellt.
- ☑ Spannbacken werden kundenspezifisch nach Zeichnung geschliffen und gehärtet
- ☑ Die Spannbacken sind austauschbar (3 Stück)
- ☑ Internal clamping collet
- ☑ F20, F25, F37, F42, F48 collets type available
- ☑ Clamping capacity from 1.5 mm
- ☑ Manufactured according to the technical drawing of the part to be clamped.
- ☑ Clamping jaws are custom ground and hardened according to drawing
- ☑ The collet jaws are interchangeable (3 pieces)

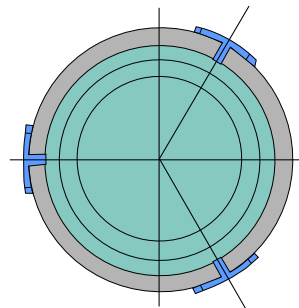
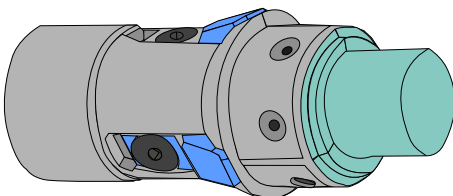
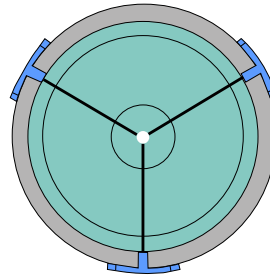
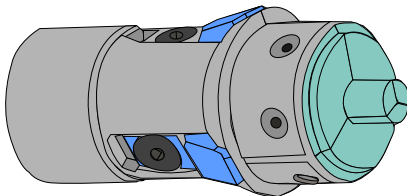

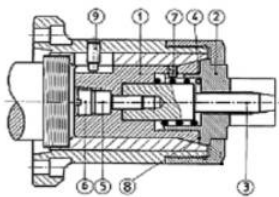
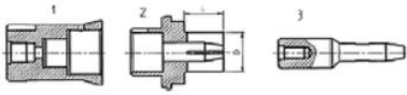

- ☑ GEXP 173E (F48) Rollen mit Innengewinde werden in CNC-Drehmaschinen verwendet.
- ☑ Es kann auf der Werkbank mit der Standard-Spannzange 173E (F48) verwendet werden.
- ☑ Vier verschiedene Durchmesser zum Anziehen von innen nach außen erhältlich
- ☑ Härte 50 HRC und kann gedreht werden
- ☑ GEXP 173E (F48) Internal clamping collet for CNC Lathes machines
- ☑ Usable with existing collet 173E (F48) on the CNC Lathes
- ☑ 4 types of sleeves and the nose delivering with the suitable sleeve
- ☑ Sleeve hardness 50 HRC and can be turned

Art.-Nr.	Bezeichnung Description	Position
GEXP 173 Komplett GEXP 173 Complete	Aufnahme EXP für 173 E komplett mit Körper, Schrauben, Feder, Scheiben, je 1 St. Hülse u. Druckstange. GEXP 173E (F48) internal clamping collet, screw, spring, disc, sleeve and push bar	
GEXP 173 Grund	Grundkörper Collet 173E (F48)	1
GEXP 173 H 1521	Hülse/Sleeve Ø15 - 21 / L= 30	2
GEXP 173 H 2031	Hülse/Sleeve Ø20 - 31 / L= 30	2
GEXP 173 H 2942	Hülse/Sleeve Ø29 - 42 / L= 30	2
GEXP 173 H 3550	Hülse/Sleeve Ø35 - 50 / L= 50	2
GEXP 173 D 215	Druckstange/Nose	3
GEXP 173 D 315	Druckstange/Nose	3
GEXP 173 D 430	Druckstange/Nose	3
GEXP 173 D 505	Druckstange/Nose	3
	Feder/Spring	4
	Schraube/Screw	5
	Schraube/Screw	6
	Schraube/Screw	7
	Scheibe/Slice	8
	Schraube/Screw	9

Maschinentyp STAR Machine Type STAR	Hauptspindel- Spannzange Main Spindle Collet	Führungsbuchse Guide Bush	Gegenspindel- Spannzange Sub-Spindle Collet	Spannzange Mit Vorbau Sharp Pointed Collet
SW 7-7	109E F10	F3001 / 3.001 / /J4	109E F10	109E F10
SW 7 - 10 / JNC 10 / SR 10J	120E F15	I353 / 8.001 / J6R	120E F15	120E F15
ECAS 12 / SV 12 / RNC 16 A / SR 16 / SR 16 R / VNC 16 / SB 16 Typ C/D/E / SA 16 RC / SA 12/16	138E F20	F391 / 39.001 / J7AR	138E F20	138E F20
SA 12	138E F20	T221 / 450.001 / B301	138E F20	138E F20
SW-12R II / SB-12R Typ E/N/G	1212E F16	F853 / 166.001 / B212A	1212E F16	1212E F16
SI 12	138E F20	F391 / 39.001 / J7AR	120E F15	120E F15
JNC 16	138E F20	T221 / 450.001 / B301		
	138E F20	I354 / 13.001 / J7A		
SR 20 / SR 20 R II/III / SR 20 J / SB 20 C/E / ECAS 20 / ECAS 20 T / SW 20 / SV20	145E F25	T223 / 22.001 / B261	145E F25	145E F25
SR 20 J Typ N (Kurzdrehvar.)	145E F25		145E F25	145E F25
Durchlasserweiterung von ø 20 mm auf ø 23,0 mm	147E F27	T223 S (erweit- erter Durchlass)	147E F27	
JNC 25 / JNC 32 / KNC 25 / VNC 32 / SR 32 J / ECAS 32 T / SV 32 / SV 32 JII / SR 32 J Typ N (Kurzdrehvariante)	1536E F37	T229 / 28.001 / J9	1536E F37	1536E F37
ST 38	173E F48	T248 / 464.001	173E F48	173E F48

Maschinentyp HANWHA Machine Type HANWHA	Hauptspindel- Spannzange Main Spindle Collet	Führungsbuchse Guide Bush	Gegenspindel- Spannzange Sub-Spindle Collet	Spannzange Mit Vorbau Sharp Pointed Collet
SL 12 S/H	120E F15	F853 / 166.001 / B212A	120E F15	120E F15
SL 16 S/H	140E F22	F391 / 39.001 / J7AR	140E F22	140E F22
SL 20 S / XD 20 H	145E F25	T223 / 22.001 / B261	145E F25	145E F25
SL 26 S/H / SL 26 HP II	161E F32	T227 / 451.001 / B227	161E F32	161E F32
SL 32 S/HE / SL 32 HPD / SL 32HP II / STL 32 H	1536E F37	T229 / 28.001 / J9	1536E F37	1536E F37
SL 35 HP		T245 / B250		

Maschinentyp DMG Machine Type DMG	Hauptspindel- Spannzange Main Spindle Collet	Führungsbuchse Guide Bush	Gegenspindel- Spannzange Sub-Spindle Collet	Spannzange Mit Vorbau Sharp Pointed Collet
GLD 12 / SPEED 12/5 / 12/7 linear	120E F15	F853 / 166.001 / B212A	120E F15	120E F15
GD 16	136E F20	F391 / 39.001 / J7AR	136E F20	136E F20
GLD 20	145E F25	I357 / 18.001 / B260	SY GL 20	
SPEED 20/8 / 20/11 linear	145E F25	T223 / 22.001 / B261	145E F25	145E F25
GLD 25 / 4 Achsen	1446E F30	T227 / 451.001 / B227	1446E F30	1446E F30
GLD 25 / 5 Achsen	1446E F30	T227 / 451.001 / B227	SY GL 20	
GD 32 / SPEED 32/10 linear	1536E F37	T229 / 28.001 / J9	1536E F37	1536E F37

Maschinentyp CITIZEN Machine Type CITIZEN	Hauptspindel- Spannzange Main Spindle Collet	Führungsbuchse Guide Bush	Gegenspindel- Spannzange Sub-Spindle Collet	Spannzange Mit Vorbau Sharp Pointed Collet
R 04	101E F8	I351 / 51.001 / J3		
R 07	120E F15	F3001 / 3.001 / J4	120E F15	120E F15
D 10 / E 10 / F 10 / L10 / F 12	120E F15	I353 / 8.001 / J6R	120E F15	120E F15
K 12 / B 12 / C 12 / M 12	1212E F16	F853 / 166.001 / B212A	1212E F16	1212E F16
K 16 / C 16 / M 16	138E F20	F605 / 61.002 / B238	138E F20	138E F20
D 16 / F 16 / G 16 / L 16	145E F25	F605 / 61.002 / B238	145E F25	145E F25
A 20 / B 20 / L 20 / M 20 / F 20	145E F25	T223 / 22.001 / B261	145E F25	145E F25
A 20 / VII GBL	Z.sp. 67E		145E F25	145E F25
F 25 / L 25 / E 25	157E F30	T227 / 451.001 / B227	157E F30	
C 32 / F 32 / L 32 / M 32 /	1536E F37	T229 / 28.001 / J9	1536E F37	1536E F37

Maschinentyp NEXTURN Machine Type NEXTURN	Hauptspindel- Spannzange Main Spindle Collet	Führungsbuchse Guide Bush	Gegenspindel- Spannzange Sub-Spindle Collet	Spannzange Mit Vorbau Sharp Pointed Collet
SA12A	1212E F16	F853 / 166.001 / B212A	1212E F16	1212E F16
SA 18 A / SA 20 D / SA 20 E	145E F25	T223 / 22.001 / B261	145E F25	145E F25
SA 26 D / SA 26 E	161E F32	T227 / 451.001 / B227	161E F32	161E F32
SA 32 D / SA 32 E	1536E F37	T229 / 28.001 / J9	1536E F37	1536E F37
SA 38	F44/92 / 511.026	T246 / 467.001 / B246	F44/92 / 511.026	

Maschinentyp TRAUB Machine Type TRAUB	Hauptspindel- Spannzange Main Spindle Collet	Führungsbuchse Guide Bush	Gegenspindel- Spannzange Sub-Spindle Collet	Spannzange Mit Vorbau Sharp Pointed Collet
TNL 12/7	1212E F16	F605 / 61.002 / B238	1212E F16	1212E F16
	136E F20	T221 / 450.001 / B301	136E F20	136E F20
	120E F15	FTS 221 (Traub 989 468)	120E F15	120E F15
TNL 16 bis ø 16,0	136E F20	F391 / 39.001 / J7AR	138E F20	138E F20
	138E F20	FTS 3402 (Traub 989 517)		
	145E F25			
TNL 16 bis ø 20 / TNL 16G	144E F25	T223 / 22.001 / B261	144E F25	144E F25
TNL 18	145E F25	T223 / 22.001 / B261	145E F25	145E F25
		TNL 18 (Traub 902 860)		
TNL 26	157E F30	T227 / 451.001 / B227	157E F30	
TNL 26/32	1536E F37	SB.D/0001	1536E F37	1536E F37
TNL 32	1536E F37	EC 42 Stahlaus- führung	1536E F37	1536E F37
		EC 42 in HM- Ausführung		

Maschinentyp TORNOS Machine Type TORNOS	Hauptspindel- Spannzange Main Spindle Collet	Führungsbuchse Guide Bush	Gegenspindel- Spannzange Sub-Spindle Collet	Spannzange Mit Vorbau Sharp Pointed Collet
Micro 7	109E F10	F3001 / 3.001 / J4	109E F10	109E F10
DECO 7	109E F10	I352 / F3001 / 3.001 / J4	109E F10	
Micro 8 / Sigma 8	321E W15		116E F13	116E F13
DECO 10 a/e	116E F13	I353 / 8.001 / J6R	116E F13	116E F13
Delta 12/4 12/5 / Delta 20/4 20/5 / Gamma 20/5 20/6	145E F25	TD26 / 99.001	145E F25	145E F25
DECO 13 a/e / EvoDECO 16 a/e / ENC 164	136E F20	F605 / 61.002 / B238	136E F20	136E F20
DECO 20 a/e	145E F25	I357 / 18.001 / B260	145E F25	145E F25
DECO 20 erweitert / Sigma 20	1446E F30	T227 / 451.001 / B227	145E F25	1446E F30
DECO 26 a/e	1446E F30	T227 / 451.001 / B227	1446E F30	1446E F30
DECO 26 erweitert / Sigma 32	1536E F37	T229 / 28.001 / J9	1536E F37	1536E F37

Maschinentyp TSUGAMI Machine Type TSUGAMI	Hauptspindel- Spannzange Main Spindle Collet	Führungsbuchse Guide Bush	Gegenspindel- Spannzange Sub-Spindle Collet	Spannzange Mit Vorbau Sharp Pointed Collet
BO 07 / BW 07	109E F10	F3001 / 3.001 / J4		
BO 12 / BS 12 / BW 12 / NB 12 / BO 18 / BS 18	140E F22	F605 / 61.002 / B238	140E F22	140E F22
BA 20 / BN 20 / BS 20	145E F25	I357 / 18.001 / B260	145E F25	145E F25
HS 20-7	145E F25	TD26 / 99.001	145E F25	145E F25
BA 26 / BU 26 / BS 26	161E F32	T227 / 451.001 / B227	161E F32	161E F32
BS 32	1536E F37	488.001	1536E F37	1536E F37
BH 38	173E F48	T249 / B240 / 496.001	173E F48	173E F48

Maschinentyp DOOSAN Machine Type DOOSAN	Hauptspindel- Spannzange Main Spindle Collet	Führungsbuchse Guide Bush	Gegenspindel- Spannzange Sub-Spindle Collet	Spannzange Mit Vorbau Sharp Pointed Collet
Puma ST 20 G	145E F25	T223 / 22.001 / B261	145E F25	145E F25

Puma ST 32 G	1536E F37	T229 / 28.001 / J9	1536E F37	1536E F37
--------------	-----------	--------------------	-----------	-----------

Maschinentyp VAN Machine Type VAN	Hauptspindel- Spannzange Main Spindle Collet	Führungsbuchse Guide Bush	Gegenspindel- Spannzange Sub-Spindle Collet	Spannzange Mit Vorbau Sharp Pointed Collet
MR20-V7/V8	145E F25	T223 / 22.001 / B261	145E F25	145E F25

MR38-V7/V8	173E F48	T248 / 464.001	173E F48	173E F48
------------	----------	----------------	----------	----------

SMART12 V7/V8	138E F20	F391 / 39.001 / J7AR	138E F20	138E F20
---------------	----------	----------------------	----------	----------

SMART16 V7/V8	138E F20	T221 / 450.001 / B301		
---------------	----------	-----------------------	--	--

SMART20 V7/V8	145E F25	T223 / 22.001 / B261	145E F25	145E F25
---------------	----------	----------------------	----------	----------

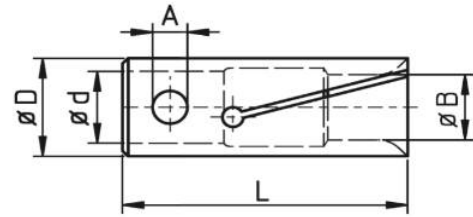

Art.-Nr.	Spannzangentyp Collet Type	ØD	d	A	L	Maximale Bohrung Maximum Bore (B)
GSP05	200E	5	M4	-	37	1,0 - 3,9
GSP07	208E	7	M5	-	37	1,0 - 5,7
GSP10	210E	10	7	4	40	1,0 - 8,9
GSP11		11	7	4	40	8,2 - 9,5
GSP12	212E	12	8	4	40	1,0 - 10,1
GSP13		13	8	4	40	3,0 - 12,0
GSP14		14	8	4	40	10,0 - 12,0
GSP15	203E	15	11	6	40	1,5 - 13,4
GSP16		16	11	6	40	4,0 - 13,9
GSP18	218E	18	11	6	40	3,0 - 16,5
GSP20	225E	20	14	8	65	2,0 - 17,9
GSP21		21	14	8	65	18,0 - 19,5
GSP22		22	14	8	65	3,0 - 20,4
GSP23		23	14	8	65	19,0 - 20,0
GSP24		24	14	8	65	16,0 - 22,0
GSP25	222E	25	20	8	65	2,0 - 23,0
GSP26		26	20	8	65	23,0 - 24,0
GSP28	227E	28	20	8	65	6,0 - 26,5
GSP30		30	20	8	65	4,0 - 28,0
GSP32		32	20	8	65	3,0 - 30,5
GSP34		34	20	8	65	25,0 - 32,0
GSP36		36	20	8	65	4,0 - 34,0
GSP42		42	20	8	70	10,0 - 39,0
GSP52		52	20	8	70	8,0 - 49,0

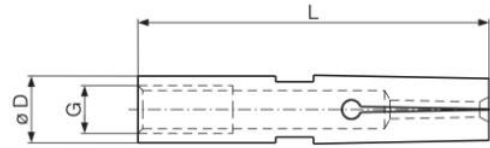

Art.-Nr.	ØD	L	Gewinde Thread G	Maximale Bohrung Maximum Bore
GFED 05.01	5.15	37	M4x0.7	1,0 - 3,5
GFED 8.5.01	8.5	30	M5x0.8	1,0 - 7,0
GFED 08.01	8	50	M4x0.7	1,0 - 6,0
GFED 09.01	9	40	M6x0.75	1,0 - 7,0
GFED 9.5.01	9.5	45	M5x0.8	1,0 - 8,0
GFED 10.01	10	50	M5x0.8	1,0 - 8,0
GFED 10.02	10	42	M6x0.75	1,0 - 8,0
GFED 14.01	14	42	M8x1	3,0 - 12,0
GFED 15.01	15	40	M5x0.5	3,0 - 13,0
GFED 15.02	15	42	M8x1	3,0 - 13,0
GFED 15.03	15	60	M8x1	3,0 - 13,0
GFED 15.04	15	60	M10x1	3,0 - 13,0
GFED 16.01	16	42	M8x1	12,0 - 14,0
GFED 18.01	18	59	M10x1	13,0 - 16,0
GFED 19.01	19	40	M8x1	13,0 - 17,0
GFED 19.02	19	59	M10x1	12,0 - 17,0
GFED 20.01	20	59	M9x1	13,0 - 17,0
GFED 20.02	20	60	M10x1	13,0 - 17,0
GFED 20.03	20	42	M10x1	8,0 - 17,0
GFED 22.01	22	59	M10x1	18,0 - 20,0
GFED 23.01	23	59	M10x1	18,0 - 21,0
GFED 25.01	25	59	M10x1	18,0 - 23,0
GFED 25.02	25	60	M17x1	13,0 - 23,0
GFED 26.5.01	26,5	65	M17x1	15,0 - 23,0
GFED 27.01	27	65	M10x1	15,0 - 25,0
GFED 30.01	30	65	M10x1	25,0 - 28,0
GFED 30.02	30	65	M18x1.5	18,0 - 28,0
GFED 32.01	32	80	M25x1.5	20,0 - 30,0
GFED 35.01	35	80	M25x1.5	30,0 - 33,0
GFED 40.01	40	80	M25x1.5	33,0 - 38,0
GFED 46.01	46	80	M25x1.5	38,0 - 44,0

Art.-Nr.	ØD	L	Gewinde Thread G	Maximale Bohrung Maximum Bore
GFED 9.5.01L	9.5	45	M5x0.8 Sol	1,0 - 7,5
GFED 10.01L	10	50	M5x0.8 Sol	1,0 - 8,0
GFED 10.02L	10	46	M6x1 Sol	1,0 - 8,0
GFED 12.01L	12	45	M5x0.8 Sol	1,0 - 10,0
GFED 12.02L	12	40	M6x1 Sol	1,0 - 10,0
GFED 13.01L	13	50	M5x0.8 Sol	1,0 - 11,0
GFED 13.02L	13	60	M8x1 Sol	1,0 - 11,0
GFED 14.01L	14	42	M7x0.75 Sol	3,0 - 12,0
GFED 15.01L	15	16	M8x1 Sol	3,0 - 13,0
GFED 15.02L	15	50	M9x1 Sol	3,0 - 13,0
GFED 15.03L	15	73	M10x1 Sol	3,0 - 13,0
GFED 15.04L	15	85	M12x1 Sol	3,0 - 13,0
GFED 16.01L	16	58	M9x1 Sol	3,0 - 14,0
GFED 16.02L	16	73	M10x1 Sol	3,0 - 14,0
GFED 18.01L	18	42	M9x1 Sol	6,0 - 16,0
GFED 18.02L	18	60	M9x1 Sol	13,0 - 16,0
GFED 18.03L	18	59	M10x1 Sol	13,0 - 16,0
GFED 19.01L	19	50	M8x0.8 Sol	13,0 - 17,0
GFED 19.02L	19	60	M9x1 Sol	13,0 - 17,0
GFED 20.01L	20	59	M9x1 Sol	13,0 - 18,0
GFED 20.02L	20	60	M10x1 Sol	13,0 - 18,0
GFED 22.01L	22	59	M9x1 Sol	18,0 - 20,0
GFED 23.01L	23	60	M9x1 Sol	18,0 - 21,0
GFED 24.01L	24	60	M9x1 Sol	18,0 - 22,0
GFED 25.01L	25	60	M9x1 Sol	18,0 - 23,0
GFED 25.02L	25	59	M10x1 Sol	18,0 - 23,0
GFED 27.01L	27	59	M9x1 Sol	15,0 - 25,0
GFED 27.02L	27	65	M10x1 Sol	15,0 - 25,0
GFED 29.01L	29	65	M18x1.5 Sol	17,0 - 27,0
GFED 30.01L	30	65	M10x1 Sol	17,0 - 27,0
GFED 30.02L	30	65	M18x1.5 Sol	18,0 - 28,0
GFED 32.01L	32	70	M17x1 Sol	19,0 - 30,0
GFED 32.02L	32	80	M25x1.5 Sol	3,0 - 29,0
GFED 35.01L	35	80	M25x1.5 Sol	27,0 - 32,0
GFED 42.01L	42	80	M25x1.5 Sol	25,0 - 39,0
GFED 52.01L	52	80	M25x1.5 Sol	36,0 - 47,0
GFED 60.01L	60	80	M25x1.5 Sol	45,0 - 55,0

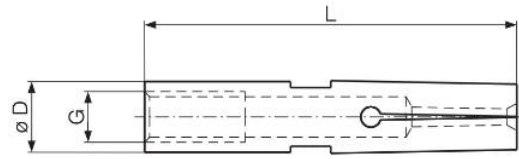

LNS TRYTON

Art.-Nr.	ØD	L	Gewinde Thread G	Maximale Bohrung Maximum Bore	Spanntoleranz Clamping Tolerance
GSP LNS 06	6	30	M4	0,8 - 5,0	0,1
GSP LNS 07	7	30	M4	1,0 - 6,0	0,1
GSP LNS 10	10	30	M5	1,5 - 8,5	0,1
GSP LNS 12	12	30	M6	2,0 - 11,0	0,1
GSP LNS 125	12,5	30	M6	8,0 - 11,5	0,1
GSP LNS 165	16,5	35	M8	3,0 - 15,0	0,1
GSP LNS 17	17	35	M10	3,0 - 15,5	0,1
GSP LNS 20	20	35	M10	3,0 - 18,0	0,1
GSP LNS 22	22	35	M10	3,0 - 20,5	0,1
GSP LNS 25	25	35	M10	5,0 - 23,5	0,1
GSP LNS 30	30	35	M10	6,0 - 28,5	0,1
GSP LNS 32	32	35	M10	6,0 - 30,5	0,1

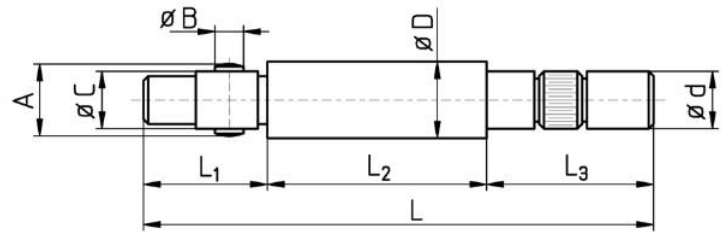

FMB, HAGENUK, TRAUB, SYMCO, IEMCA

Art.-Nr.	Ød	ØD	A	B	C	L1	L2	L3	L
GSPA LD 10 H	8	10	9,8	4	7	26,5	43,5	30	100
GSPA LD 12 H	8	12,3	11,8	4	8	26,5	43,5	30	100
GSPA LD 13 H	8	13	11,8	4	8	26,5	43,5	30	100
GSPA LD 15 H/T	12	15	14,8	6	11	26,5	43,5	30	100
GSPA LD 16 H/T	12	16	15,8	6	11	26,5	43,5	30	100
GSPA LD 18 H/T	12	18	17,8	6	11	26,5	43,5	30	100
GSPA LD 20 H/T	17	20	19,8	8	14	40,5	45,5	30	116
GSPA LD 22 H/T	17	22	21,8	8	14	40,5	45,5	30	116
GSPA LD 23 H/T	17	23	21,8	8	14	40,5	45,5	30	116
GSPA LD 25 H/T	20	25	24,8	8	20	43	46	30	119
GSPA LD 28 H/T	20	28	24,8	8	20	43	46	30	119
GSPA LD 30 H/T	20	30	29,8	8	20	43	46	30	119
GSPA LD 32 H/T	20	32	31,8	8	20	43	46	30	119
GSPA LD 36 H/T	20	36	35,8	8	20	43	46	30	119
GSPA LD 42 H/T	20	42	41,8	8	20	43	46	30	119
GSPA LD 52 H/T	20	52	51,8	8	20	43	46	30	119

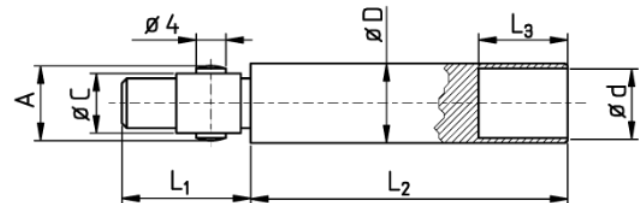

TRAUB

Art.-Nr.	ØD	A	C	d	L1	L2	L3
GSPA LD 10 T	10	9,9	7	9	24	61	18
GSPA LD 12 T	12	11,9	8	11	24	61,5	18

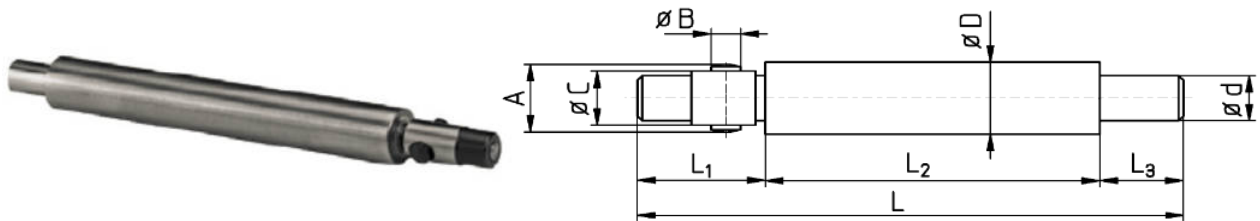

TORNOS ROBOBAR

Art.-Nr.	Ød	ØD	A	B	C	L1	L2	L3	L
GSPA LD ROB 055	M3	5,5	-	-	M4	7	78	8	93
GSPA LD ROB 075	5	7,5	-	-	M5	7	78	16	101
GSPA LD ROB 105	7	10,5	9,8	4	7	27	73	16	116
GSPA LD ROB 120	8	12	11,8	4	8	28	72	16	116
GSPA LD ROB 160	10	16	15,5	6	11	26	116	16	158
GSPA LD ROB 180	10	18	17,8	6	11	28	116	16	160
GSPA LD ROB 205	14	20,5	19,8	8	14	40	110	20	170
GSPA LD ROB 250	20	25	24,8	8	20	42	117	22	181
GSPA LD ROB 260	20	26	24,8	8	20	43	114	22	179

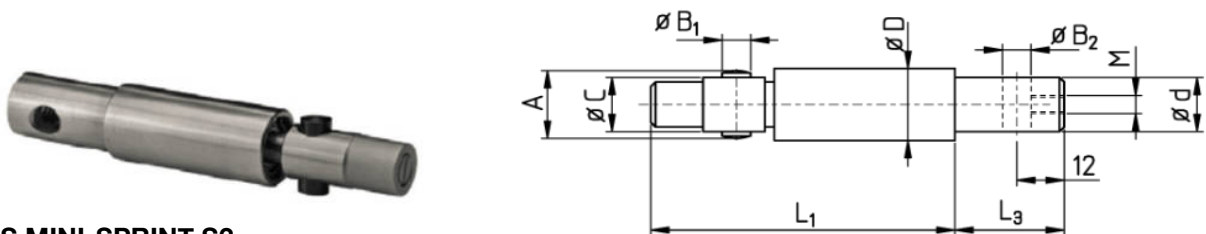

LNS MINI-SPRINT S2

Art.-Nr.	Ød	ØD	A	B1/B2	C	L1	L3	M
GSPA 10 LNS	8	10	10	4	7	67	30	M 4
GSPA 12 LNS	8	12	12	4	8	69	30	-
GSPA 15 LNS	12	15	15	6	11	67	30	M 5
GSPA 18 LNS	12	18	18	6	11	70	30	-
GSPA 20 LNS	17	20	20	8	14	81	30	M 8
GSPA 25 LNS	20	25	25	8	20	85,5	30	M 8
GSPA 36 LNS	30	36	36	8/-	20	158	40	-
GSPA 50 LNS	42	50	-	-	20	158	50	-

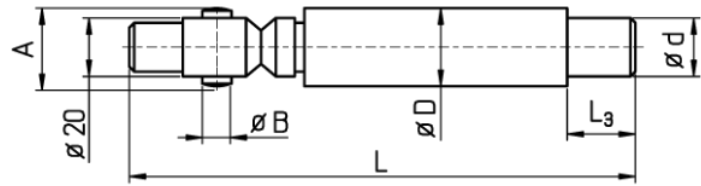

FMB

Art.-Nr.	Ød	ØD	A	B	L3	L
GSPA LDTS 25	20	25	24,8	8	40	197
GSPA LDTS 28	25	28	25,8	8	40	197
GSPA LDTS 30	25	30	25,8	8	40	197
GSPA LDTS 32	25	32	31	8	40	197
GSPA LDTS 34	30	34	31	8	40	197
GSPA LDTS 36	30	36	35	8	40	207
GSPA LDTS 38	30	38			40	207
GSPA LDTS 40	33	40			50	207
GSPA LDTS 42	33	42			50	207
GSPA LDTS 50	42	50			50	207
GSPA LDTS 60	51	60			75	232
GSPA LDTS 63	51	63			75	232
GSPA LDTS 65	51	65			75	232

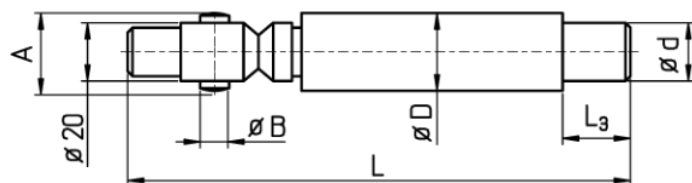

TORNOS

Art.-Nr.	Ød	ØD	A	B	L3	L
GSPA LDTR 32	22	32	31	8	30	192
GSPA LDTR 36	25	36	35	8	30	192

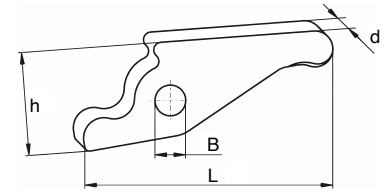

CITIZEN

Maschinenmodell Machine Model	Bezeichnung Description	d	L	h	B
A 32 NEW, A20		10	91		8
B 12 B-Spindel	B 312 U53 - 413	6	44		4
B 12 B-Spindel	B 12 U 50X416	4	36		4
B12, BS 2, K16 Main	F412 SX 117	8	55	21,3	6
BS 20, K 16 B-Spindel	B 20 U 50 C 111	8	25,5		6
C 16 Main-/ B-Spindel					
F 12, L 20	F 412 SC 117	8	55	21,3	6
G 16		6	52	17,5	4
L 16 E, L 20 Main		10	73		8
L 16/20, A 20 (L=55mm#)	L 216 C114	6	55		4
L 16/20 B-Spindel. L10 L16/N Main	L216 U41B 122	6	52,2		4
M 20/32, L 25, C 32, A20		10	72,3	24	8

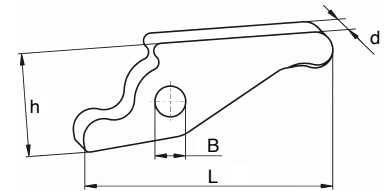

HANWHA

Maschinenmodell Machine Type	Bezeichnung Description
HANEX 17 ML 12 Sub Spindle	NPS 7000-019 / 3184-S050-1091
HANDEX 17 XD 20, SL20S, SL16, ML20, Mainspindle	BSS 3000-021 / 3170-MS10-1060
HANEX 25 ML 20/26 XD 20, 32 HPD SL 26S/H SL32S/ SL20/26/32/35HP 2	SSS 7000-012 / 3192-M011-1080
HANEX 25 ML26 SL26S/H SL32S SL20/26/32/35HP2 32HPD Mainspindle	SSS 3000-015 3173-M010-1140
SL 12 Mainspindle XD 12 Mainspindle	3184-M010-1130 / NPM 0100 S 113
SL 12 Se/S/H Subspindle. SL 16 Subspindle	BSS 7000 004 / 3224-S020-2200
STL 32J/H Main-/Subspindle	SST 11000-022
STL 38 H	ST 11000-819
X 3 PJT	PA 12000-011
XD 26 H Subspindle	DA 15999-005
XD 26 H Mainspindle	SM 02026-001
XD 32 H Main-/Subspindle	CA 11000-013A
XP 12; ML12 Mainspindle	XOS3000-015



Maschinenmodell Machine Type	Bezeichnung Description	d	L	h	B
GD 16, GD 20 Sub Spindel	55.10.107	10	53,5	28,6	7
GD 20 Main Spindel	55.10.227	10	58	23,5	
GD 32	56.10.129				
GD 32	56.10.327				
GLD 12-16	55.10.107	10	53,5	28,6	7
GLD 20-25-32	54.10.119	10	58	25	7
GLD- Pin to GLD 20-25-32 (7x42,5)	54.10.117				
GM 26	43.01.206				
GM 26 AC	41.01.193				
GM 35 Special	37.01.158				
GM 35/8, GMC 35	42.01.293	15,5	95,5	29,8	
GMC 20 S	51.01.284	11,8	65,5	22,1	
GMC 42	57.01.299				
MSL	60.10.92				
MSL 42/60	94.10.123				
MSL 60/7	56.10.322	10	55		7
Speed 12	20.10.136	10	56,4		7
Speed 20 Main/Sub- Speed 20-8Main	21.10.141				
Speed 20-8 Sub Spindel	20.10.136				
Sprint 20	21.10.141				
Sprint 32	54.10.254				
Sprint 32 Linear	56.10.322				
Sprint 32/42	26.10.196				
Sprint 32/42	26.10.147				
Sprint 42 Sub Spindle	56.10.322				
Sprint 42 Main Spindle	26.10.123	13	99,4	32	10
Sprint 50 Linear	94.10.123				

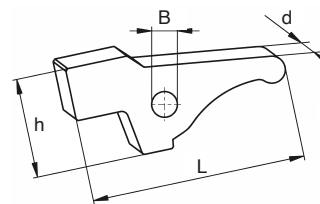

Maschinenmodell Machine Type	Spindel	Bezeichnung Description	d	L	h	B
ECAS-20	Subspindle	540-39-600/620	10	67		8
ECAS-32T	Mainspindle	580-320-70	12	89,7		8
ECAS-32T A48	Subspindle	580-840-70	12	77		8
JNC 16	Mainspindle	025-32-060/080	10	72,5		6
JNS 25 / 32		052-32-070/090	14	69		8
KJR 16	Mainspindle	250-32-090/100	10	68		6
KJR 16	Subspindle	252-32-070/090	8	34,4		6
KJR 25	Mainspindle	260-32-070/090	12	80		8
KJR 25	Subspindle	262-32-070/90	12	80		8
KJR 25 II	Mainspindle	360-32-070/090	12	80		8
KJR 25 II	Subspindle	362-32-08/100	12	80		8
KNC 16/20	Subspindle	222-32-230/250	12	50		8
KNC 16/20	Mainspindle	220-32-070/090	12	77		8
KNC 25/32	Mainspindle	200-32-070/090	14	69	30	8
KNC 25/32	Subspindle	202-32-230/250	12	50	25,5	8
KNC 25/32 II	Mainspindle	340-32-070/090	14	69		8
KNC 25/32 II	Subspindle	342-32-230/250	12	50		8
KNC 32 II	Subspindle	342-32-231/250	12	54		8
RNC 16	Mainspindle	210-32-060/080	10	68		6
RNC 16	Subspindle	270-82-080/100	6	32,5		5
RNC SR 32	Subspindle	342-32-23/250	12	54		8
SA 16/12	Mainspindle	460-32-100/120	10	68		6
SA 16/12	Subspindle	460-82-080/100	8	39		6
SB 16	Subspindle	480-82-070	8	39		6
SB 16	Mainspindle	460-32-100/120	10	68		6
SE / SH 16	Mainspindle	400-32-100/120	10	68		6
SH 7		410-32-100/120	8	56		6
SNC 15		196-32-060/080	10	72,5		6
SNC 25		091-32-060/080	14	85		8
SR 10 J	Mainspindle	460-82-080/100	8	39		6

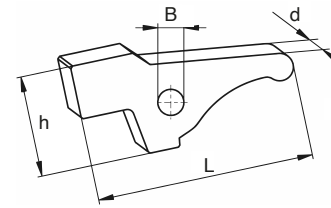

Maschinenmodell Machine Type	Spindel	Bezeichnung Description	d	L	h	B
SR 10 J	Subspindle	690-83-070/090	5	40		6
SR 16	Mainspindle	310-32-090/100	10	68		6
SR 16	Subspindle	312-32-070/090	8	39		6
SR 16 R		540-39-100	10	67		8
SR 20	Subspindle	322-32-070/090	12	50		8
SR 20 R		540-84-050/070	12	57		8
SR 20 R	Mainspindle	540-39-600/620	10	67		8
SR 20 RII + III		660-84-050	12	57		8
SR 20 RII + III	Mainspindle	660-39-600	10	67		8
SR 20/32		330-32-090/100	12	80		8
SR 32	Subspindle	332-32-090/110	12	54		8
SR 32 J	Main-/Subspindle	670-320-90/110	12	67,6		8
SST 16		300-32-090/100	10	68		6
SST 16	Mainspindle	210-32-060/080	10	68		6
SST 16	Subspindle	302-32-079/090	8	39		6
ST 38	Main-/Subspindle	0B0-32-130/100				
SV 12	Mainspindle	540-39-600/620	10	67		8
SV 12	Subspindle	452-32-100/120	10	72		8
SV 12		823-00-306	10	72		8
SV 20	Main-/Subspindle	420-32-060/080	12	78		8
SV 32	Mainspindle I	440-32-090	12	80		8
SV 32	Mainspindle II	430-32-090	12	80		8
SV 32 J	Subspindle	442-32-090/110	12	62		8
SW 7/R	Mainspindle	380-32-130/150	8	56		6
SW 7/R	Subspindle	382-32-110/130	8	56		6
VNC 20	Mainspindle	750-32-060/080	12	77		8
VNC 20	Subspindle	749-32-180/190	8	34,4		6
VNC 32		780-32-060/080	14	69		8



Maschinenmodell Machine Type	Spindel	Bezeichnung Description	d	L	h	B
AS 14 SAS 16	Mainspindle	12 149	7,9	48		6
AS 14, SAS 16	Gripper equipment	24 17	4,9	32,4		4
TV,T4		TV 5	6	43,2	16	4,5
M 4		MF 3549	6	40,6		
M 4		MF 433	6	47		4
M 4		MF 7817	6	50		4
M7		MD 265	6,8	58	18,3	5
M7	Strengthened	MD 9705	6,9	62,6		5
MS 7		MD 14103	6	62,7		5
MS 7	Stop	MD 15825	7,9	64,1		5
M 7		MD 15355	5,9	48,5		5
M 10		MA 6469	6,9	60		5
M 15		B 45 I	9	70,9	24,3	7
M 20		J 51	12	90,9	30	8
M 25		C 157	11,9	103	30	8
R 10		5 RA 87	11,2	66		
R 10	New	5 RA 87-06	11,4	69,8		7
R 16		5 RB 5031	13,4	74,4	20	
RR 20		RB 5105	13,4	82,6		
R 7		RD 4039	9	54		
M 7	Witg stop	MA 4911	7	53		
RR 20-01		RB 5105-01	13,5	82		
NA 12, NA 153		098 098	9	55	21,3	6
G 85		MR 28-32	14	109		9
ENC 163		810 965	10	36		5
BS 20		045 397	11,95	39,5		5,95
BS 20 8 SPR		096 900	4,92	34,9		4
MTH	Milling unit	4/MT 359				

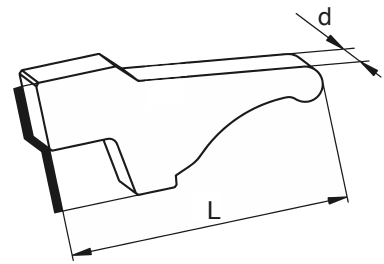

Maschinenmodell Machine Type	Spindel	Bezeichnung Description	d	L	h	B
S 16		3192-S030-1060	8	57		
S 20	B-Spindle	3192-S030-1060	8	57		
NF 20/17	B-Spindle	3171-M011-1140	12	57		
HS 20	Mainspindle	3262-M010-1301				
HS 207	Main-/B-Spindle	3262-M010-1301				
BO 205E	Maim-/B-Spindle	3262-M010-1301				
BS 12, BO 12	Mainspindle	3192-M011-1080	12	57		
BS 12-18 BO 12-18	B-Spindle	3192-M011-1080	12	57		
BS 20	Mainspindle	3192-M011-1080	12	57		
BS 20-26-32	B-Spindle	3192-M011-1080	12	57		
HS 20/26-32	B-Spindle	3192-M011-1080	12	57		
S 16	Mainspindle	3192-M011-1080	12	57		
BN 20	Mainspindle	3192-M011-1080	12	57		
HS 207	Mainspindle	3192-M011-1080	12	57		
B0 12	Mainspindle	3184-M010-1130	8	57		
NP 11	B-Spindle	3184-S050-1091	12	57		
NP 17	B-Spindle	3184-S050-1091	12	57		
NP 17	Mainspindle	3170-M210-1060	12	57		
BS 18	Mainspindle	3170-M210-1060	12	57		
B0 18	Mainspindle	3170-M210-1060	12	57		
BO/BS/BW/BN 12	(B=8mm)	3224-S020-2200	12	57		
NP 17 20-32	Mainspindle	3173-M010-1140	12	85,2		
BS 26-32	Mainspindle	3173-M010-1140	12	85,2		
HS 26	Mainspindle	3173-M010-1140	12	85,2		
BH 38E	Main-/B-Spindle	3173-M010-1140	12	85,2		
BU 38	Main-/B-Spindle	3173-M010-1140	12	85,2		
TMU IE	Mainspindle	3173-M010-1140	12	85,2		
BO 385E	Main-/B-Spindle	3173-M010-1140	12	85,2		

Spannzangenfutter mit Zylinderschaft ER8 Mini Collet Chuck with Cylindrical Shank ER8 Mini

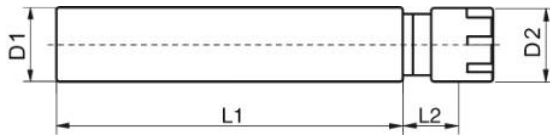

Art.-Nr.	Bezeichnung Description	D1	D2	L2	L1
605.2M.105	D5-45 ER8 Mini Collet Chuck	5	12	20	45
608.2M.105	D8-55 ER8 Mini Collet Chuck	8	12	20	55
608.2M.205	D8-100 ER8 Mini Collet Chuck	8	12	20	100
610.2M.105	D10-80 ER8 Mini Collet Chuck	10	12	20	80
610.2M.205	D10-100 ER8 Mini Collet Chuck	10	12	20	100
612.2M.105	D12-80 ER8 Mini Collet Chuck	12	12	20	80
612.2M.205	D12-100 ER8 Mini Collet Chuck	12	12	20	100
612.2M.405	D12-160 ER8 Mini Collet Chuck	12	12	20	160
612.2M.605	D12-200 ER8 Mini Collet Chuck	12	12	20	200

Spannzangenfutter mit Zylinderschaft ER11 Mini Collet Chuck with Cylindrical Shank ER11 Mini

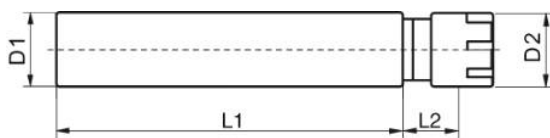

Art.-Nr.	Bezeichnung Description	D1	D2	L2	L1
612.2M.107	D12-70 ER11 Mini Collet Chuck	12	16	30	70
612.2M.207	D12-100 ER11 Mini Collet Chuck	12	16	30	100
612.2M.407	D12-150 ER11 Mini Collet Chuck	12	16	30	150
616.2M.207	D16-100 ER11 Mini Collet Chuck	16	16	30	100
616.2M.307	D16-130 ER11 Mini Collet Chuck	16	16	30	130
616.2M.407	D16-160 ER11 Mini Collet Chuck	16	16	30	160
616.2M.507	D16-200 ER11 Mini Collet Chuck	16	16	30	200
616.2M.607	D16-250 ER11 Mini Collet Chuck	16	16	30	250
616.2M.707	D16-300 ER11 Mini Collet Chuck	16	16	30	300

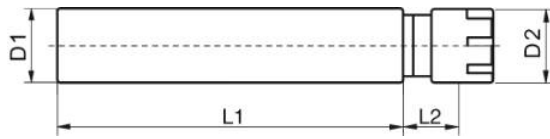

Art.-Nr.	Bezeichnung Description	D1	D2	L2	L1
616.2M.210	D16-100 ER16 Mini Collet Chuck	16	22	28	100
616.2M.410	D16-160 ER16 Mini Collet Chuck	16	22	28	160
616.2M.510	D16-200 ER16 Mini Collet Chuck	16	22	28	200
620.2M.010	D20-50 ER16 Mini Collet Chuck	20	22	28	50
620.2M.110	D20-70 ER16 Mini Collet Chuck	20	22	28	70
620.2M.110-D	D20-70 ER16 Mini Collet Chuck Double	20	22	28	70
620.2M.110-IK	D20-70 ER16 Mini Collet Chuck IK	20	22	28	70
620.2M.210	D20-100 ER16 Mini Collet Chuck	20	22	28	100
620.2M.410	D20-160 ER16 Mini Collet Chuck	20	22	28	160
620.2M.510	D20-200 ER16 Mini Collet Chuck	20	22	28	200
620.2M.710	D20-300 ER16 Mini Collet Chuck	20	22	28	300
622.2M.110	D22-62 ER16 Mini Collet Chuck	22	22	28	62
622.2M.110-D	D22-112 ER16 Mini Collet Chuck Double	22	22	28	112
622.2M.110-IK	D20-70 ER16 Mini Collet Chuck IK	20	22	28	70
622.2M.210	D22-102 ER16 Mini Collet Chuck	22	22	28	102
622.2M.210-D	D22-144 ER16 Mini Collet Chuck Double	22	22	28	144
622.2M.210-IK	D22-105 ER16 Mini Collet Chuck IK	22	22	28	105
622.2M-310	D22-129 ER16 Mini Collet Chuck	22	22	28	129
622.2M.410	D22-150 ER16 Mini Collet Chuck	22	22	28	150

IK= Innenkühlung / Internal Cooling

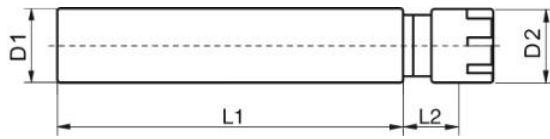

Art.-Nr.	Bezeichnung Description	D1	D2	L2	L1
632.2M.213	D32-105 ER20 Mini Collet Chuck	32	28	32	105
632.2M.213-IK	D32-105 ER20 Mini Collet Chuck IK	32	28	32	105

IK= Innenkühlung / Internal Cooling

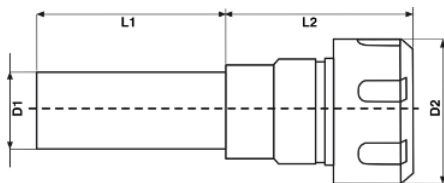

Art.-Nr.	Bezeichnung Description	D1	D2	L2	L1
616.02.110	d16-60 ER16 1-10	16	28	35	60
616.02.310	d16-160 ER16 1-10	16	28	35	160
620.02.116	d20-70 ER25 2-16	25	42	45	70
620.02.316	d20-160 ER25 2-16	25	42	45	160
625.02.116	d25-70 ER25 2-16	25	42	45	70
625.02.316	d25-160 ER25 2-16	25	42	45	160
632.02.120	d32-70 ER32 3-20	32	50	53	70
632.02.320	d32-160 ER32 3-20	32	50	53	160
640.02.126	d40-80 ER40 4-26	40	63	56	80

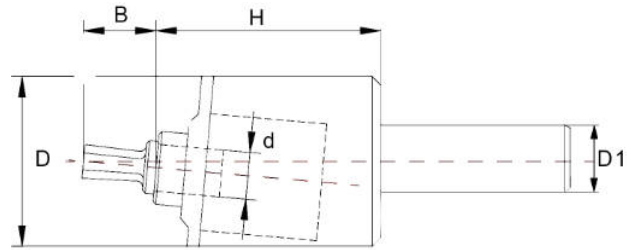

Räumwerkzeughalter

- ✓ Vierkant, Sechskant und TORX-Profile räumen
- ✓ Verwendbar auf CNC- und universellen Fräs- und Drehmaschinen und Standbohrer
- ✓ Verfügbar in SK-, BT-, DIN2080-, HSK-, VDI-, zylindrische und Morsekegelausführung
- ✓ Gehäuse aus gehärtetem Stahl

Broaching Holder

- ✓ For Broaching blind and through holes with form square, hexagon, torx and polygonal
- ✓ Usable on CNC and universal milling machines and bench drill
- ✓ SK, BT, DIN2080, HSK, VDI, Cylindrical and Morse Taper Shank connection types available
- ✓ Hardened steel body

Art.-Nr.	d	Wellendurchmesser Shaft Diameter D1	Körpergröße Body Size H x D	B	6-Kant Hexagon	4-Kant Square	Torx	Max. Räumtiefe Max Broaching Depth
BR-G05-C12	Ø5	8 / 10 / 12 / 15,875 / 16 / 19,05 / 20 / 22	34x22	10	1-6	1-4		7
BR-G08M-C16	Ø8	10 / 12 / 16 / 19,05 / 20 / 25 / 25,40	48x28	18	1-8	1-6	T5-T15	14
BR-G08-C22	Ø8	12 / 16 / 19,05 / 20 / 22 / 25 / 25,40	46x35	18	1-10	1-8	T5-T20	14
BR-G12B-C25	Ø12	19,05 / 20 / 22 / 25 / 25,40	55x45	25	1-14	1-10	T5-T30	20
BR-G12-C25	Ø12	25 / 32	78x58	25	1-14	1-12	T5-T50	20
BR-G16-C32	Ø16	25 / 32	95x70	25	1-24	1-16	T5-T60	21

Räumgröße Broaching Capacity	Harter Stahlzyklus Hard Material Cycle	Fortschritt aus hartem Stahl Feed Rate Hard Steel	Weicher Legierungszyklus Soft Alloy Cycle	Weicher Legierungsfortschritt Feed Rate Soft Alloy
Sechskant Hexagon (1-6)	800/1000	0,05 - 0,1	1200/1500	0,1 - 0,15
Sechskant Hexagon (7-12)	700/900	0,05 - 0,1	1000/1300	0,1 - 0,15
Sechskant Hexagon 13 –	600/800	0,05 - 0,1	900/1100	0,1 - 0,15
Vierkant / Square 1-6	800/1000	0,04 - 0,09	1200/1500	0,07 - 0,12
Vierkant / Square 7-12	700/900	0,04 - 0,09	1000/1300	0,07 - 0,12
Vierkant / Square 13 –	600/800	0,04 - 0,09	900/1100	0,07 - 0,12
Torx T05-T20	800/1000	0,04 - 0,09	1200/1500	0,07 - 0,12
Torx T25-T55	700/900	0,04 - 0,09	1000/1300	0,07 - 0,12
Torx T60	600/800	0,04 - 0,09	900/1100	0,07 - 0,12



Räumdorne

- HSS-Material
- TiN, TiCN, INOX-PLUS -Beschichtung auf Anfrage
- 8mm, 12mm und 16mm Schaft
- Sechskant, Vierkant und TORX-Profile

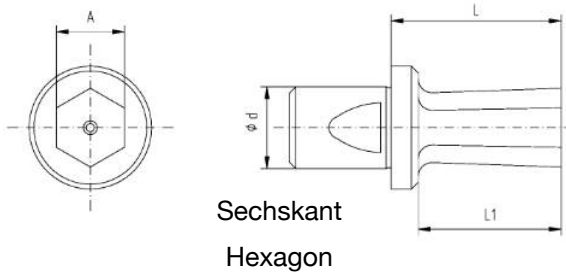

Internal and External Broaching Inserts

- HSS-Material
- TiN, TiCN, INOX-PLUS coating on request
- 8mm, 12mm and 16mm shank
- Hexagon, Square and TORX profiles

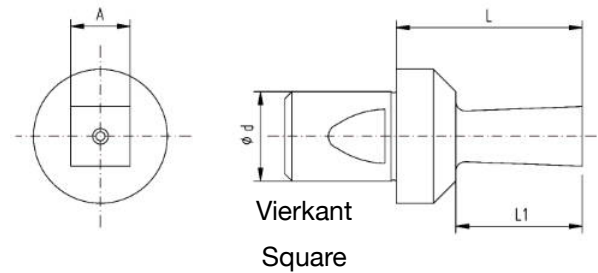

Art.-Nr.	d	A	Toleranz Tolerance	L1	L
G8-E-2	8	2	+0,05 +0,07	5	18
G8-E-2,5	8	2,5	+0,05 +0,07	6	18
G8-E-3	8	3	+0,06 +0,08	7	18
G8-E-3,5	8	3,5	+0,06 +0,08	8	18
G8-E-4	8	4	+0,07 +0,09	9	18
G8-E-4,5	8	4,5	+0,07 +0,09	9	18
G8-E-5	8	5	+0,08 +0,10	11	18
G8-E-5,5	8	5,5	+0,08 +0,10	11	18
G8-E-6	8	6	+0,08 +0,10	13	18
G8-E-7	8	7	+0,08 +0,10	15	18
G8-E-8	8	8	+0,08 +0,10	15	18
G8-E-9	8	9	+0,08 +0,10	15	18
G8-E-10	8	10	+0,08 +0,10	15	18

Art.-Nr.	d	A	Toleranz Tolerance	L1	L
G8-Q-2	8	2	+0,05 +0,07	5	18
G8-Q-2,5	8	2,5	+0,05 +0,07	6	18
G8-Q-3	8	3	+0,06 +0,08	7	18
G8-Q-3,5	8	3,5	+0,06 +0,08	8	18
G8-Q-4	8	4	+0,07 +0,09	9	18
G8-Q-4,5	8	4,5	+0,07 +0,09	9	18
G8-Q-5	8	5	+0,08 +0,10	11	18
G8-Q-5,5	8	5,5	+0,08 +0,10	11	18
G8-Q-6	8	6	+0,08 +0,10	13	18
G8-Q-7	8	7	+0,08 +0,10	15	18
G8-Q-8	8	8	+0,08 +0,10	15	18

- Auf Anfrage mit TiN-, TiCN-, INOX-PLUS-Beschichtung
- On Request with TiN, TiCN, INOX-PLUS Coating

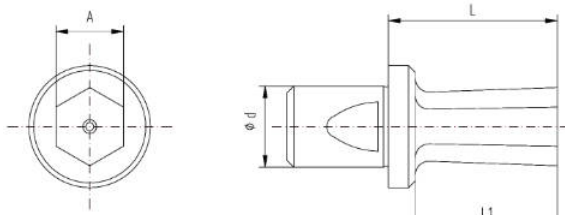

Sechskant
Hexagon

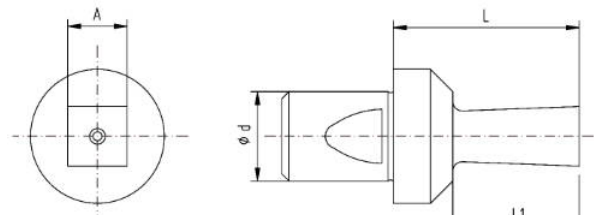

Vierkant
Square

Art.-Nr.	d	A	Toleranz Tolerance	L1	L
G12-E-2	12	2	+0,05 +0,07	5	25
G12-E-2,5	12	2,5	+0,05 +0,07	6	25
G12-E-3	12	3	+0,06 +0,08	7	25
G12-E-3,5	12	3,5	+0,06 +0,08	8	25
G12-E-4	12	4	+0,07 +0,09	9	25
G12-E-4,5	12	4,5	+0,07 +0,09	9	25
G12-E-5	12	5	+0,08 +0,10	11	25
G12-E-5,5	12	5,5	+0,08 +0,10	11	25
G12-E-6	12	6	+0,08 +0,10	13	25
G12-E-7	12	7	+0,08 +0,10	15	25
G12-E-8	12	8	+0,08 +0,10	17	25
G12-E-9	12	9	+0,09 +0,11	19	25
G12-E-10	12	10	+0,10 +0,12	21	25
G12-E-11	12	11	+0,10 +0,12	21	25
G12-E-12	12	12	+0,11 +0,13	21	25
G12-E-13	12	13	+0,11 +0,13	21	25
G12-E-14	12	14	+0,12 +0,14	21	25

Art.-Nr.	d	A	Toleranz Tolerance	L1	L
G12-Q-2	12	2	+0,05 +0,07	5	25
G12-Q-2,5	12	2,5	+0,05 +0,07	6	25
G12-Q-3	12	3	+0,06 +0,08	7	25
G12-Q-3,5	12	3,5	+0,06 +0,08	8	25
G12-Q-4	12	4	+0,07 +0,09	9	25
G12-Q-4,5	12	4,5	+0,07 +0,09	9	25
G12-Q-5	12	5	+0,08 +0,10	11	25
G12-Q-5,5	12	5,5	+0,08 +0,10	11	25
G12-Q-6	12	6	+0,08 +0,10	13	25
G12-Q-7	12	7	+0,08 +0,10	15	25
G12-Q-8	12	8	+0,08 +0,10	17	25
G12-Q-9	12	9	+0,09 +0,11	19	25
G12-Q-10	12	10	+0,10 +0,12	21	25
G12-Q-11	12	11	+0,10 +0,12	21	25
G12-Q-12	12	12	+0,11 +0,13	21	25

- Auf Anfrage mit TiN-, TiCN-, INOX-PLUS-Beschichtung
- On Request with TiN, TiCN, INOX-PLUS Coating

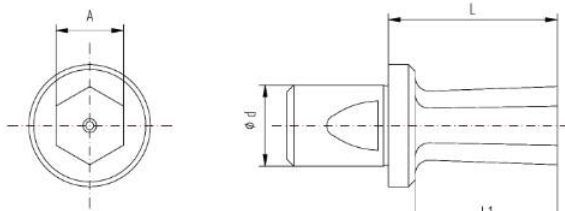
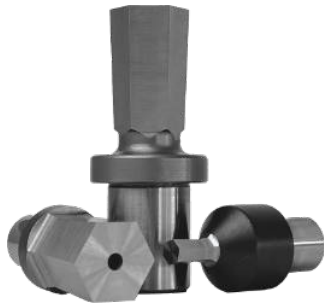

Sechskant
Hexagon

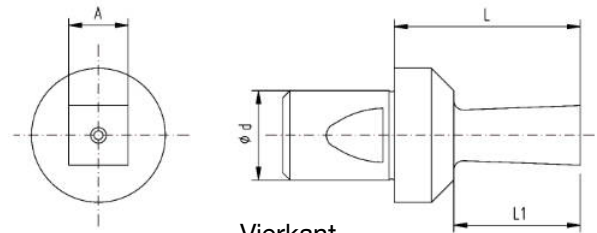

Vierkant
Square

Art.-Nr.	d	A	Toleranz Tolerance	L1	L
G16-E-2	16	2	+0,05 +0,07	5	25
G16-E-2,5	16	2,5	+0,05 +0,07	6	25
G16-E-3	16	3	+0,06 +0,08	7	25
G16-E-3,5	16	3,5	+0,06 +0,08	8	25
G16-E-4	16	4	+0,07 +0,09	9	25
G16-E-4,5	16	4,5	+0,07 +0,09	9	25
G16-E-5	16	5	+0,08 +0,10	11	25
G16-E-5,5	16	5,5	+0,08 +0,10	11	25
G16-E-6	16	6	+0,08 +0,10	13	25
G16-E-7	16	7	+0,08 +0,10	15	25
G16-E-8	16	8	+0,08 +0,10	17	25
G16-E-9	16	9	+0,09 +0,11	19	25
G16-E-10	16	10	+0,10 +0,12	21	25
G16-E-11	16	11	+0,10 +0,12	21	25
G16-E-12	16	12	+0,11 +0,13	21	25
G16-E-13	16	13	+0,11 +0,13	21	25
G16-E-14	16	14	+0,12 +0,14	21	25

Art.-Nr.	d	A	Toleranz Tolerance	L1	L
G16-Q-2	16	2	+0,05 +0,07	5	25
G16-Q-2,5	16	2,5	+0,05 +0,07	6	25
G16-Q-3	16	3	+0,06 +0,08	7	25
G16-Q-3,5	16	3,5	+0,06 +0,08	8	25
G16-Q-4	16	4	+0,07 +0,09	9	25
G16-Q-4,5	16	4,5	+0,07 +0,09	9	25
G16-Q-5	16	5	+0,08 +0,10	11	25
G16-Q-5,5	16	5,5	+0,08 +0,10	11	25
G16-Q-6	16	6	+0,08 +0,10	13	25
G16-Q-7	16	7	+0,08 +0,10	15	25
G16-Q-8	16	8	+0,08 +0,10	17	25
G16-Q-9	16	9	+0,09 +0,11	19	25
G16-Q-10	16	10	+0,10 +0,12	21	25
G16-Q-11	16	11	+0,10 +0,12	21	25
G16-Q-12	16	12	+0,11 +0,13	21	25
G16-Q-13	16	13	+0,11 +0,13	21	25
G16-Q-14	16	14	+0,12 +0,14	21	25

- Auf Anfrage mit TiN-, TiCN-, INOX-PLUS-Beschichtung
- On Request with TiN, TiCN, INOX-PLUS Coating

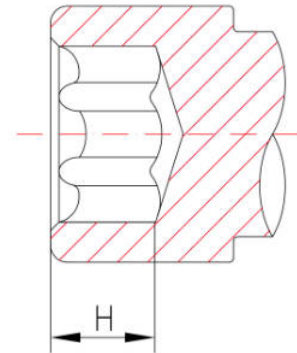
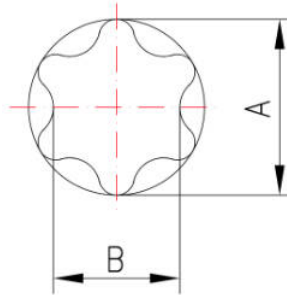

Art.-Nr.	Torx	A	B	H
GT8-T5	5	1,48	1,06	0,40 0,60
GT8-T6	6	1,80	1,29	0,50 0,70
GT8-T7	7	2,08	1,49	0,60 0,80
GT8-T8	8	2,45	1,80	0,70 0,90
GT8-T9	9	2,58	1,85	0,80 1,00
GT8-T10	10	2,85	2,07	1,00 1,30
GT8-T15	15	3,38	2,44	1,30 1,50
GT8-T20	20	3,96	2,68	1,50 1,60
GT8-T25	25	4,55	3,28	1,60 2,00
GT8-T27	27	5,10	3,65	2,00 2,40
GT8-T30	30	5,65	4,07	2,60 3,00
GT8-T40	40	6,80	4,88	3,00 3,30

Art.-Nr.	Torx	A	B	H
GT16-T10	10	2,85	2,07	1,00 1,30
GT16-T15	15	3,38	2,44	1,30 1,50
GT16-T20	20	3,96	2,86	1,50 1,60
GT16-T25	25	4,55	3,28	1,60 2,00
GT16-T27	27	5,10	3,65	2,00 2,40
GT16-T30	30	5,65	4,07	2,60 3,00
GT16-T40	40	6,80	4,88	3,00 3,30
GT16-T45	45	7,97	5,68	3,50 4,00
GT16-T50	50	8,99	6,50	4,00 4,50
GT16-T55	55	11,41	8,1	4,30 5,20
GT16-T60	60	13,49	9,66	5,10 6,00

Art.-Nr.	Torx	A	B	H
GT12-T5	5	1,48	1,06	0,40 0,60
GT12-T6	6	1,80	1,29	0,50 0,70
GT12-T7	7	2,08	1,49	0,60 0,90
GT12-T8	8	2,45	1,80	0,70 0,90
GT12-T9	9	2,58	1,85	0,80 1,00
GT12-T10	10	2,85	2,07	1,00 1,30
GT12-T15	15	3,38	2,44	1,30 1,50
GT12-T20	20	3,96	2,86	1,50 1,60
GT12-T25	25	4,55	3,28	1,60 2,00
GT12-T27	27	5,10	3,65	2,00 2,40
GT12-T30	30	5,65	4,07	2,60 3,00
GT12-T40	40	6,80	4,88	3,00 3,30
GT12-T45	45	7,97	5,68	3,50 4,00
GT12-T50	50	8,99	6,50	4,00 4,50
GT12-T55	55	11,41	8,1	4,30 5,20

- Schafttoleranz der Werkzeuge g6
- Auf Anfrage mit TiN-, TiCN-, INOX-PLUS-Beschichtung
- Shank of Broaching Inserts with g6 tolerance
- On request TiN, TiCN, INOX-PLUS Coating



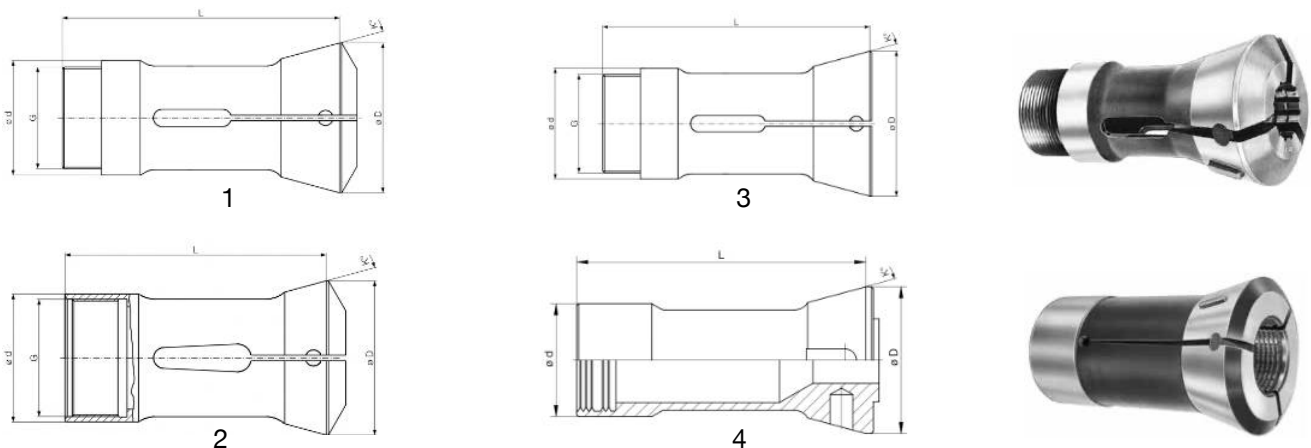

Gildemeister

Art.-Nr.	Bild Pic	Ød	ØD	L	K°	Gewinde Thread (G)	Maximale Bohrung Max Bore			Typ Type
							Ø	⬡	□	
9013 E	1	26,8	34	83,5	15	M24 x 1,0L	13	11	9	AS12
9023 E	4	30	39	77	15	bayonet	20	17	11	GM16 AC
9012 E	1	34	42	85	16	M30 x 1,0L	20	17	14	AS16-AS20-GM20
9017 E	2	38	45,5	85	16	M34,5 x 0,75L	25	22	18	AS20/25-GM20
9044 E	2	45	60,4	159	15	M40 x 1,5L	22	19	15	AS22
9045 E	2	45	60,4	159	15	M40 x 1,0L	25	22	18	AS25
9046 E	2	45	60,4	159	15	M40 x 1,5L	25	22	18	GS25
9069 E	2	53	69,4	128	15	M48 x 1,5L	32	27	22	AS/AV/GM32-GM25
9081 E	2	56	72	131	15	M52 x 1,5L	35	30	24	GS35
9115 E	2	64	80,5	129	15	M59 x 1,5L	42	36	28	GM42
9132 E	2	70	90	149	15	M65 x 1,5L	48	41	33	AS/AV/AA/AR48
9151 E	2	75	97,4	165	15	M68 x 1,5L	50	43	35	GS50
9151 E-1	2	75	93,4	155	15	M68 x 1,5L	50	43	35	GS31
9178 E	2	90	115	170	15	M85 x 1,5L	67	58	47	AS67
9209 E	2	109	138	189	15	M102 x 1,5L	82	70	57	AS/AV82
9239 E	2	128	160,4	250	15	M122 x 1,5L	100	87	71	AS100

Index

Art.-Nr.	Bild Pic	Ød	ØD	L	K°	Gewinde Thread (G)	Maximale Bohrung Max Bore			Typ Type
							Ø	⬡	□	
9007 E	1	32	41,5	79	15	M28 x 1,0L	19	16	13	MS16
9033 E	1	40	55,2	102	15	M35 x 1,5 Ro.L	22	19	15	KS20-KS22
9039 E	3	46	60,5	112	15	M40 x 1,5L	25	22	18	KS/MS25
9070 E	1	53	69,3	128	15	M47 x 1,5L	32	28	23	KS32
9081 E	2	56	72	131	15	M52 x 1,5L	35	30	24	MS35
9108 E	1	62	82,4	178	15	M58 x 1,5L	42	36	30	KS42
9133 E	1	70	92	154,5	15,5	M65 x 2,0L	50	43	35	KS50
9151 E	2	75	97,4	165	15	M68 x 1,5L	50	43	35	MS50

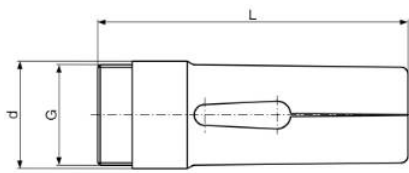

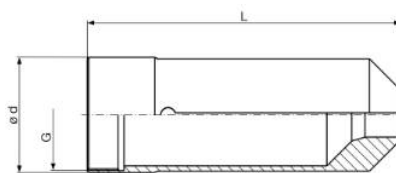

1





2



Gildemeister



Art.-Nr.	Bild Pic	Ød	L	Gewinde Thread (G)	Maximale Bohrung Max Bore			Typ Type
					Ø			
9259E	2	19,5	82	M17 x 1	13	11	9	AS12
9268E	1	22	86	M20 x 1	16	14	11	GM16 AC
9258E	1	25	90	M24 x 1	20	17	14	AS16-AS/GS20-
9288E	1	30,5	90	M28,5 x 0,75	25	22	18	AS20 erw.25
9286E	1	32	140	M28 x 1,5L	22	19	15	AS22
9287E	1	33	140	M30 x 1L	25	22	18	AS25
9289E	1	33,6	140	M30 x 1L	25	22	18	GS25
9316E	1	40	136	M38 x 1,5L	32	27	22	AS/AV32
9335E	1	41,2	136	M39 x 1Ro.L	35	30	24	GM32 erw.35-GM
9336E	1	41,5	136	M38 x 1,5Ro.L	32	27	22	GM32
9333E	1	45	136	M42 x 1,5L	35	30	24	GM35
9374E	1	51,5	136	M48 x 1,5	42	36	28	GM42
9368E	1	57	160	M54 x 1,5L	48	41	33	AS/AV/AA/AR48
9401E	1	60	160	M57 x 1,5L	50	43	35	GS50-GS51
9447E	1	77,5	170	M74 x 1,5L	67	58	47	AS67
9475E	1	94	180	M88 x 1,5L	82	70	57	AS/AV82
9483E	1	114	235	M108 x 1,5L	100	87	71	AS100

Index

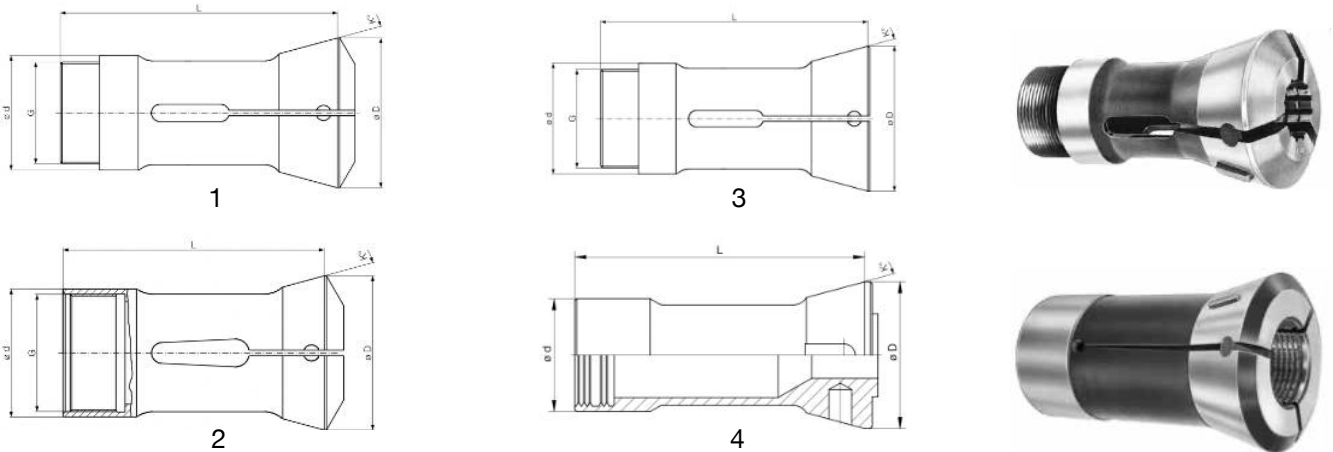

Art.-Nr.	Bild Pic	Ød	L	Gewinde Thread (G)	Maximale Bohrung Max Bore			Typ Type
					Ø			
9255E	1	25	88	M23 x 1	19	16	13	MS16
9273E	1	30,8	102	M28 x 1,5Ro.L	22	19	15	KS20-KS22
9282E	1	35 (37)	118	M33 x 1,5	25	22	18	KS/MS25
9319E	1	41,8	130	M38 x 1,5	32	28	23	KS32
9333E	1	45	136	M42 x 1,5L	35	30	24	MS20
9364E	1	54	170	M50 x 1,5L	42	36	30	KS42
9402E	1	60	156	M57 x 2L	50	43	35	KS50
9401E	1	60	160	M57 x 1,5L	50	43	35	MS50





Tornos

Art.-Nr.	Bild Pic	Ød	ØD	L	K°	Gewinde Thread (G)	Maximale Bohrung Max Bore			Typ Type
							Ø			
9001E	2	25	35	73	15°30'	M22 x 1	14	12	10	AS/BS14
9021E	1	25	35	92	15°30'	M25 x 1	16	14	11	AS/SAS16
9018E	1	35	45	105	15°30'	M33 x 1	23	20	16	BS20/22
9020E	2	36	45	105	15°30'	M33 x 1,25	21	18	14	BS20B

Tornos Bechler

Art.-Nr.	Bild Pic	Ød	ØD	L	K°	Gewinde Thread	Maximale Bohrung Max Bore			Typ Type
							Ø			
9012E	1	34	4	85	16	M30 x 1L	20	17	14	Multi Deco 20-6 / 20,8
9049E-1	1	46	60,3	112	15	M40 x 1,5L	25	22	18	Multi Deco 26-6

Wickmann

Art.-Nr.	Bild Pic	Ød	ØD	L	K°	Gewinde Thread	Maximale Bohrung Max Bore			Typ Type
							Ø			
9014E	4	29,4	38,1	90,5	15	1,03" x 1/24"L	16	13	11	5/8"
9034E	2	41	54,5	130,2	15	1,484" x 1/24"L	25	22	17	1"
9072E	2	55	66,8	113,5	16	2,001" x 1/22"	32	27	22	1,3/8"
9111E	2	64,21	78,7	127	15	2,376" x 1/16"	32	27	22	1,3/4"



Bild 1





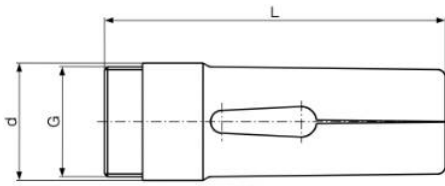

Bild 2



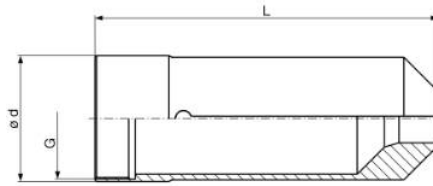

Tornos

Art.-Nr.	Bild Pic	Ød	L	Gewinde Thread	Maximale Bohrung Max Bore			Typ Type
					Ø			
9251E	1	17,9	70	M16 x 0,75	14	12	10	AS/BS14
9251E-1	1	18,3	70	M17 x 0,75	15	13	10	AS/BS14
9265E	1	22,8	98	M20 x 0,75	16	14	11	AS/SAS16
9266E	1	27,7	116	M25 x 1	21	18	14	BS20B
9263E	1	29,7	116	M27 x 1	23	20	16	BS20/22

Tornos Bechler

Art.-Nr.	Bild Pic	Ød	L	Gewinde Thread	Maximale Bohrung Max Bore			Typ Type
					Ø			
9258E	1	25	90	M24 x 1	20	17	14	Multi Deco 20-6 / 20-8
9282E	1	35 (37)	118	M33 x 1,5	25	22	18	Multi Deco 26-6

Wichmann

Art.-Nr.	Bild Pic	Ød	L	Gewinde Thread	Maximale Bohrung Max Bore			Typ Type
					Ø			
9260E	1	21,5	85,5	0,771" x 1/24"	16	13	11	5/8"
9276E	1	31,9	133,4	1,184" x 1/24"	26	22	17	1"
9318E	1	42,6	117,5	1,593" x 1/22"	32	27	22	1,3/8"
9362E	1	52,2	127	1,968" x 1/22"	45	38	31	1,3/4"

Art.-Nr.	Bild Pic	Ød	ØD	L	K°	Gewinde Thread	Ø
302 E	1	8	13	34	20	6,85 x 0,625	6
303 E	1	9,3	15	50	21	8,25 x 1/32"	7,5
313 E	1	10	14,5	73	20	M9,2 x 1	8
314 E	1	10	14	41,5	15	S9,83 x 0,833	8
318 E	1	12	16	43,5	15	S11,75 x 1,25	10
319 E	1	12	18	60	20	Tr12 x 1	10
3213 E	1	15	20,2	58,3	15	14,75 x 1,25	12,5
324 E	1	15	21,5	53	20	M13 x 1	13
330 E	1	16	24	70	20	Tr16 x 1,5	13
349 E	1	20	26,3	69	15	S19,7 x 1,667	20
350 E	1	20	27,5	117	20	M18,5 x 1,4	18
351 E	1	20	28	80	20	Tr 20 x 1,5	17,5
354 E	1	20	28	117	17,5	19 x 1/20"	17,5
355 E	1	20	28	117,5	17,5	S20 x 2	18
358 E	1	23	32	82	20	21,1 x 1	20
359 E	1	23	32	90	20	Tr23 x 1,5	20
369 E	2	24,12	32	101,5	8,5	7/16" x 1/20"	20
363 E	1	25	33,5	84	16	M23 x 1	22
364 E	1	25	34	92,5	15	S25 x 1/15"	22
366 E	1	28	36	102	18	Tr27 x 1/20"	25
367 E	1	28	38	100	20	Tr28 x 1,5	24
385 E	1	31,75	37,5	83	10	31,45 x 1/20"	26
3713 E	1	32	40	100	15	S29,7 x 1/15"	30
386 E	1	32	45	110	20	Tr32 x 1,5	29
3838 E	1	45	53	115	15	M42 x 1,5	40
389 E	1	45	60	140	20	Tr45 x 2	40
390 E	1	47	60	110	20	Tr47 x 1,5	42



Bild 1



Bild 2

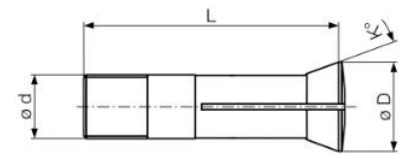

ähnlich DIN 6341

Spann-Ø		Prüf- länge L	Rundlauf	
d über	D bis		Stan- dard	Gen. Ausf.
1	1,6	6	0,02	0,01
1,6	3	10	0,02	0,01
3	6	16	0,02	0,01
6	10	25	0,02	0,01
10	18	40	0,03	0,015
18	24	50	0,04	0,02
24	30	60	0,04	0,02

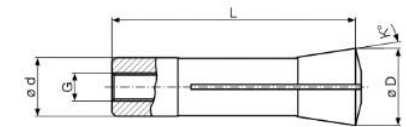
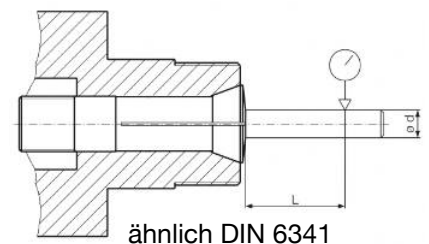
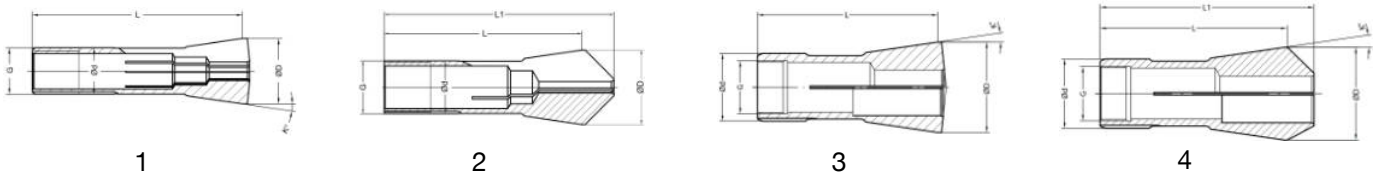

Art.-Nr.	Bild Pic	Ød	ØD	L	L1	K°	G	Ø	Steigung Increment
3148 E	1	12	18	63		8°17'50"	Tr12 x 1	10	0,5
3148 E - V	2	12	18	63	76	8°17'50"	Tr12 x 1	10	0,5
3409 E	1	20	28	90		8°17'50"	Tr20 x 1,5	16	0,5
3409 E - V	2	20	28	90	106	8°17'50"	Tr20 x 1,5	16	0,5
3718 E	1	32	45	120		8°17'50"	Tr32 x 1,5	27	0,5
3718 E - V	2	32	45	120	148	8°17'50"	Tr32 x 1,5	27	0,5
3851 E	3	45	60	120		8°17'50"	Tr35 x 1,5	36	1,0
3851 E - V	4	45	60	120	145	8°17'50"	Tr35 x 1,5	36	1,0

☑ Spannanzgen 3148 E, 3409 E, 3718 E auch mit zusätzlichem Innengewinde lieferbar

☑ Collets 3148 E, 3409 E, 3718 E also available with additional internal thread

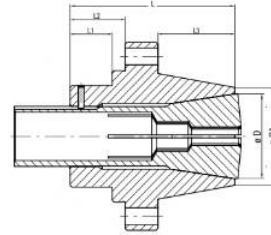

Art.-Nr.	D	D1	L	L1	L2	L3	Spannzange Collet
2.7400.2.001.000	22	70	75		7	52	3148 E
2.7400.2.001.010	22	69	105		7	82	3148 E
2.7400.2.002.000	34	70	75		7	52	3409 E
2.7400.2.002.010	34	69	105		7	82	3409 E
2.7400.2.003.000	52	66,8	90	23	30	42	3718 E
2.7400.2.003.010	52	67,5	97		7	74	3718 E
2.7400.2.004.000	70	70	105	38	45	44	3851 E

Spanndurchmesser		Prüflänge L	Rundlaufgenauigkeit Runout Precision
d über	d bis		
1	1,6	5	0,005
1,6	3	10	0,005
3	6	16	0,005
6	10	25	0,005
10	18	30	0,005
18	24	30	0,005
24	36	30	0,005

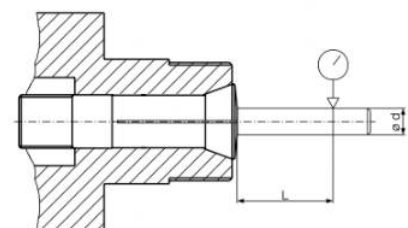

ähnlich DIN 6341

Art.-Nr.	Bezeichnung Description	B	L	H
4004E.105	4004E ER8 Ø 1-5 (9 St.)	101	82	40
4008E.107	4008E ER11 Ø 1-7 (13 St.)	101	82	49
426E.110	426E ER16 Ø 1-10 (10 St.)	101	82	40
428E.113	428E ER20 Ø 1-13 (13 St.)	101	82	40
430E.216	430E ER25 Ø 2-16 (15 St.)	235	185	48
470E.320	470E ER32 Ø 3-20 (18 St.)	275	230	83
472E.426	472E ER40 Ø 4-26 (23 St.)	340	270	83
415E.216	415E OZ16 Ø 2-16 (15 St.)	235	185	48
462E.225	462E OZ25 Ø 4-25 (16 St.)	275	230	83
467E.432	467E OZ32 Ø 5-32 (16 St.)	275	230	83



**Bezeichnung
Description**

4004E ER8 Ø 1-5 (9 St.)

1-1,5-2-2,5-3-3,5-4-4,5-5

4008E ER11 Ø 1-7 (13 St.)

1-1,5-2-2,5-3-3,5-4-4,5-5-5,5-6-6,5-7

426E ER16 Ø 1-10 (10 St.)

1-2-3-4-5-6-7-8-9-10

428E ER20 Ø 1-13 (13 St.)

1-2-3-4-5-6-7-8-9-10-11-12-13

430E ER25 Ø 2-16 (15 St.)

2-3-4-5-6-7-8-9-10-11-12-13-14-15-16

470E ER32 Ø 3-20 (18 St.)

3-4-5-6-7-8-9-10-11-12-13-14-15-16-17-18-19-20

472E ER40 Ø 4-26 (23 St.)

4-5-6-7-8-9-10-11-12-13-14-15-16-17-18-19-20-21-22-23-24-25-26

415E OZ16 Ø 2-16 (15 St.)

2-3-4-5-6-7-8-9-10-11-12-13-14-15-16

462E OZ25 Ø 4-25 (16 St.)

4-5-6-7-8-9-10-11-12-14-16-18-20-22-24-25

467E OZ32 Ø 5-32 (16 St.)

5-6-8-10-12-14-16-18-20-22-24-25-26-28-30-32

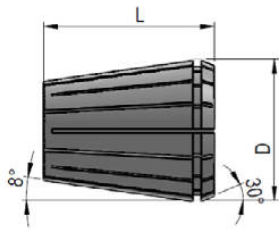

Art.-Nr.	Bezeichnung Description	D	L	Rundlauf Runout
4004E.Ø	ER8 4004E Ø 1 - 1,5 - 2 - 2,5 - 3 - 3,5 - 4 - 4,5 - 5	8,5	13,6	0,015
4008E.Ø	ER11 4008E Ø 1 - 1,5 - 2 - 2,5 - 3 - 3,5 - 4 - 4,5 - 5 - 5,5 - 6 - 6,5 - 7	11,5	18	0,015
426E.Ø	ER16 426E Ø 1 - 2 - 3 - 4 - 5 - 6 - 7 - 8 - 9 - 10	17	27,5	0,015
428E.Ø	ER20 428E Ø 1 - 2 - 3 - 4 - 5 - 6 - 7 - 8 - 9 - 10 - 11 - 12 - 13	21	31,5	0,015
430E.Ø	ER25 430E Ø 1 - 2 - 3 - 4 - 5 - 6 - 7 - 8 - 9 - 10 - 11 - 12 - 13 - 14 - 15 - 16	26	34	0,015
470E.Ø	ER32 470E Ø 2 - 3 - 4 - 5 - 6 - 7 - 8 - 9 - 10 - 11 - 12 - 13 - 14 - 15 - 16 - 17 - 18 - 19 - 20	33	40	0,015
472E.Ø	ER40 472E Ø 3 - 4 - 5 - 6 - 7 - 8 - 9 - 10 - 11 - 12 - 13 - 14 - 15 - 16 - 17 - 18 - 19 - 20 - 21 - 22 - 23 - 24 - 25 - 26	41	46	0,015

ER UP Spannzange DIN 6499 ER Collet UP DIN6499

Art.-Nr.	Bezeichnung Description	D	L	Rundlauf Runout
4004E.Ø.UP	ER8 4004E Ø 1 - 1,5 - 2 - 2,5 - 3 - 3,5 - 4 - 4,5 - 5	8,5	13,6	0,005
4008E.Ø.UP	ER11 4008E Ø 1 - 1,5 - 2 - 2,5 - 3 - 3,5 - 4 - 4,5 - 5 - 5,5 - 6 - 6,5 - 7	11,5	18	0,005
426E.Ø.UP	ER16 426E Ø 1 - 2 - 3 - 4 - 5 - 6 - 7 - 8 - 9 - 10	17	27,5	0,005
428E.Ø.UP	ER20 428E Ø 1 - 2 - 3 - 4 - 5 - 6 - 7 - 8 - 9 - 10 - 11 - 12 - 13	21	31,5	0,005
430E.Ø.UP	ER25 430E Ø 1 - 2 - 3 - 4 - 5 - 6 - 7 - 8 - 9 - 10 - 11 - 12 - 13 - 14 - 15 - 16	26	34	0,005
470E.Ø.UP	ER32 470E Ø 2 - 3 - 4 - 5 - 6 - 7 - 8 - 9 - 10 - 11 - 12 - 13 - 14 - 15 - 16 - 17 - 18 - 19 - 20	33	40	0,005
472E.Ø.UP	ER40 472E Ø 3 - 4 - 5 - 6 - 7 - 8 - 9 - 10 - 11 - 12 - 13 - 14 - 15 - 16 - 17 - 18 - 19 - 20 - 21 - 22 - 23 - 24 - 25 - 26	41	46	0,005

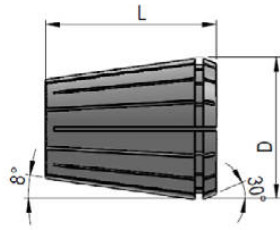

Art.-Nr.	Bezeichnung Description	D	L	Rundlauf Runout
426E.Ø.MP	ER16 426E Ø 1 - 2 - 3 - 4 - 5 - 6 - 7 - 8 - 9 - 10	17	27,5	0,002
430E.Ø.MP	ER25 430E Ø 3 - 4 - 5 - 6 - 7 - 8 - 9 - 10 - 11 - 12 - 13 - 14 - 15 - 16	26	34	0,002
470E.Ø.MP	ER32 470E Ø 3 - 4 - 5 - 6 - 7 - 8 - 9 - 10 - 11 - 12 - 13 - 14 - 15 - 16 - 17 - 18 - 19 - 20	33	40	0,002
472E.Ø.MP	ER40 472E Ø 3 - 4 - 5 - 6 - 7 - 8 - 9 - 10 - 11 - 12 - 13 - 14 - 15 - 16 - 17 - 18 - 19 - 20 - 21 - 22 - 23 - 24 - 25 - 26	41	46	0,002

ER Spannzange mit Abdichtung für IK DIN 6499
ER Collet with Seal for Internal Cooling DIN 6499

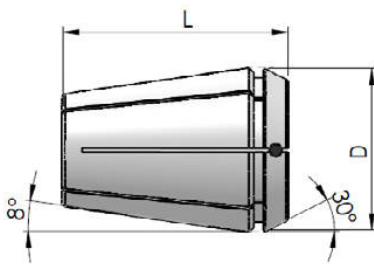

P max: 70 bar

Art.-Nr.	Bezeichnung Description	D	L
426E.NC.Ø	ER16 426E Ø 3 - 4 - 5 - 6 - 7 - 8 - 9 - 10	17	27,5
428E.NC.Ø	ER20 428E Ø 3 - 4 - 5 - 6 - 7 - 8 - 9 - 10 - 11 - 12 - 13	21	31,5
430E.NC.Ø	ER25 430E Ø 3 - 4 - 5 - 6 - 7 - 8 - 9 - 10 - 11 - 12 - 13 - 14 - 15 - 16	26	34
470E.NC.Ø	ER32 470E Ø 3 - 4 - 5 - 6 - 7 - 8 - 9 - 10 - 11 - 12 - 13 - 14 - 15 - 16 - 17 - 18 - 19 - 20	33	40
472E.NC.Ø	ER40 472E Ø 4 - 5 - 6 - 7 - 8 - 9 - 10 - 11 - 12 - 13 - 14 - 15 - 16 - 17 - 18 - 19 - 20 - 21 - 22 - 23 - 24 - 25 - 26	41	46

120 bar auf Anfrage / 120 bar versions are available On request

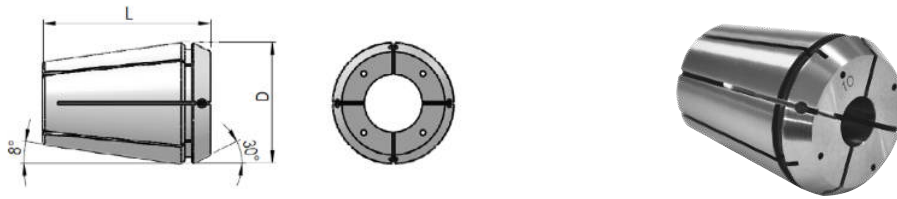

P max: 70 bar

Art.-Nr.	Bezeichnung Description	D	L
426E.NCD.Ø	ER16 426E Ø 3 - 4 - 5 - 6 - 7 - 8 - 9 - 10	17	27,5
428E.NCD.Ø	ER20 428E Ø 4 - 5 - 6 - 7 - 8 - 9 - 10 - 11 - 12 - 13	21	31,5
430E.NCD.Ø	ER25 430E Ø 3 - 4 - 5 - 6 - 7 - 8 - 9 - 10 - 11 - 12 - 13 - 14 15 - 16	26	34
470E.NCD.Ø	ER32 470E Ø 3 - 4 - 5 - 6 - 7 - 8 - 9 - 10 - 11 - 12 - 13 - 14 15 - 16 - 17 - 18 - 19 - 20	33	40
472E.NCD.Ø	ER40 472E Ø 4 - 5 - 6 - 7 - 8 - 9 - 10 - 11 - 12 - 13 - 14 - 15 - 16 - 17 - 18 - 19 - 20 - 21 - 22 - 23 - 24 - 25 - 26	41	46

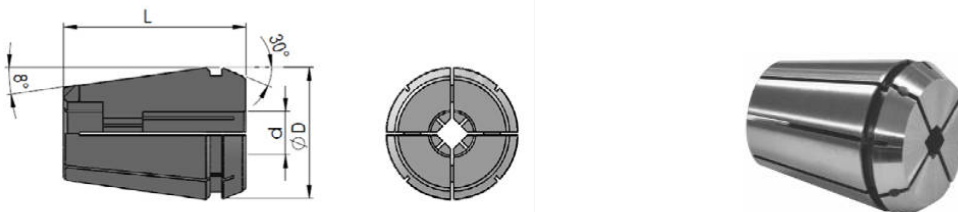

Art.-Nr.	Bezeichnung Description	D	L
426E.G.Ø	ER16 426E Ø 3,5 - 4 - 4,5 - 6 - 7 - 8	17	27,5
430E.G.Ø	ER25 430E Ø 3,5 - 4 - 4,5 - 6 - 7 - 8 - 9 - 10 - 11 - 12	26	34
470E.G.Ø	ER32 470E Ø 4,5 - 6 - 7 - 8 - 9 - 10 - 11 - 12 - 14 - 16	33	40
472E.G.Ø	ER40 472E Ø 6 - 7 - 8 - 9 - 10 - 11 - 12 - 14 - 16 - 18 - 20	41	46

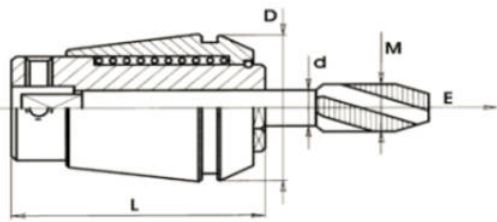

Art.-Nr.	Spannzangentyp Collet Type	D	L	E	Maximale Bohrung Maximum Bore
4008E.GK	ER11	11,5	23	5,5	Ø 2,8 - 3,5 - 4 - 4,5
426E.GK	ER16	17	27	7	Ø 2,8 - 3,5 - 4 - 4,5 - 6
428E.GK	ER20	21	31	7	Ø 2,8 - 3,5 - 4 - 4,5 - 6 - 7 - 8
430E.GK	ER25	26	34	8	Ø 2,8 - 3,5 - 4 - 4,5 - 6 - 7 - 8 - 9 - 10
470E.GK	ER32	33	43	10	Ø 4,5 - 6 - 7 - 8 - 9 - 10 - 11 - 12 - 14
472E.GK	ER40	41	54	13	Ø 4,5 - 6 - 7 - 8 - 9 - 10 - 11 - 12 - 14 - 16

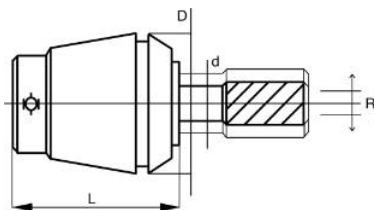

Art.-Nr.	Spannzangentyp Collet Type	D	L	R	Maximale Bohrung Maximum Bore Ød
426E.RP	ER16	17	29	0,5	2 / 3 / 4 / 5 / 6 / 7
428E.RP	ER20	21	32	0,5	3 / 4 / 5 / 6 / 7 / 8
430E.RP	ER25	26	35	0,5	3 / 4 / 5 / 6 / 7 / 8 / 9 / 10
470E.RP	ER32	33	44	0,5	4 / 5 / 6 / 7 / 8 / 9 / 10 / 11 / 12 / 13 / 14
472E.RP	ER40	41	56	0,5	5 / 6 / 7 / 8 / 9 / 10 / 11 / 12 / 13 / 14 / 15 / 16

ER Mini Pendelhalter für Spannzange
Er Mini Floating Reamer Collet

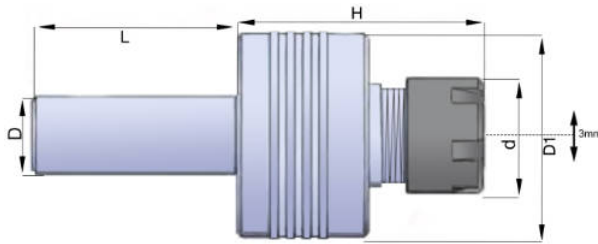

Art.-Nr.	Bezeichnung Description	D	d	H	D1	L
616.35M.107	D16 L46 ER11 Mini	16	16	40	42	46
620.35M.107	D20 L46 ER11 Mini	20	16	40	42	46
616.35M.110	D16 L46 ER16 Mini	16	22	44	42	46
620.35M.110	D20 L46 ER16 Mini	20	22	44	42	46
625.35M.110	D25 L46 ER16 Mini	25	22	44	42	46
616.35M.113	D16 L46 ER20 Mini	16	28	50	50	46
620.35M.113	D20 L46 ER20 Mini	20	28	50	50	46
625.35M.113	D25 L46 ER20 Mini	25	28	50	50	46

ER Pendelhalter für Spannzange
Er Mini Floating Reamer Collet

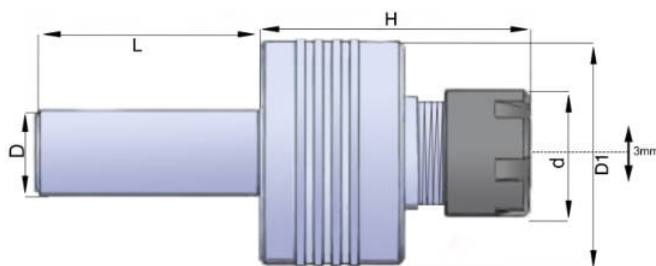

Art.-Nr.	Bezeichnung Description	D	d	H	D1	L
620.35.116	D20 L46 ER25	20	42	53	57	46
625.35.116	D25 L46 ER25	25	42	53	57	46
625.35.120	D25 L50 ER32	25	50	58	69	50
632.35.120	D32 L50 ER32	32	50	58	69	50
625.35.126	D25 L50 ER40	25	63	64	70	50
632.35.126	D32 L50 ER40	32	63	64	79	50

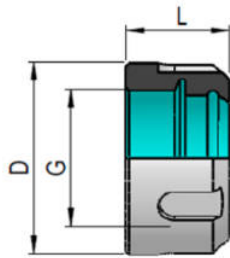

Art.-Nr.	Bezeichnung Description	D	L	Gewinde Thread G	Max. Torque
203.02.110	ER16	32	17	M22X1,5	50 Nm
203.02.113	ER20	35	19	M25X1,5	75 Nm
203.02.116	ER25	42	20	M32X1,5	85 Nm
203.02.120	ER32	50	22,5	M40X1,5	105 Nm
203.02.126	ER40	63	25,5	M50X1,5	150 Nm

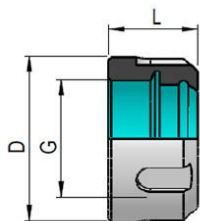

Art.-Nr.	Bezeichnung Description	D	L	Gewinde Thread G
203.02.210	ER16	32	17	M22X1,5
203.02.216	ER25	42	20	M32X1,5
203.02.220	ER32	50	22,5	M40X1,5
203.02.226	ER40	63	25,5	M50X1,5

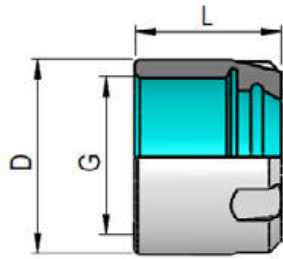

Art.-Nr.	Bezeichnung Description	D	L	Gewinde Thread G	Max. Drehmoment Max. Torq
203.2M.105	ER 8 Mini	12	10,8	M10X0,75	8 Nm
203.2M.107	ER 11 Mini	16	12	M13X0,75	18 Nm
203.2M.110	ER 16 Mini	22	18	M19X1	28 Nm
203.2M.113	ER 20 Mini	28	19	M24X1	35 Nm
203.2M.116	ER 25 Mini	35	20	M30X1	39 Nm

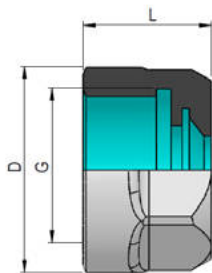

Art.-Nr.	Bezeichnung Description	D	L	Gewinde Thread G	Max. Drehmoment Max. Torq
204.02.207	ER11 X6	19	14	M14X0,75	25 Nm
204.02.210	ER16 X6	28	17,5	M22X1,5	50 Nm
204.02.213	ER20 X6	34	19	M25X1,5	75 Nm

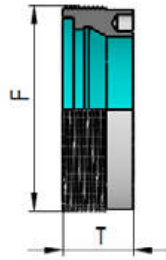

Art.-Nr.	Bezeichnung Description	F	T
207.02.207	ERX11A	M18x1	6
207.02.210	ERX16A	M24X1	8
207.02.213	ERX20A	M28x1,5	11
207.02.216	ERX25A	M32x1,5	12
207.02.220	ERX32A	M40x1,5	14
207.02.226	ERX40A	M50x1,5	18

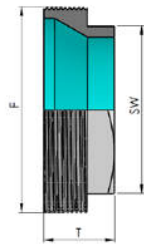

Art.-Nr.	Bezeichnung Description	F	T	SW
207.02.107	ERX11A	M18x1	9	15
207.02.110	ERX16A	M24x1	12	19
207.02.113	ERX20A	M28x1,5	13	22
207.02.116	ERX25A	M32x1,5	16,5	27
207.02.120	ERX32A	M40x1,5	19	32
207.02.126	ERX40A	M50x1,5	17	42

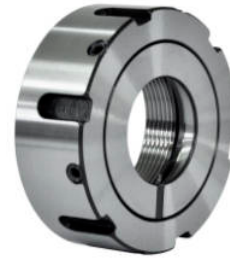
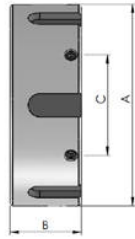

Art.-Nr.	Bezeichnung Description	A	B	Gewinde Thread G
205.02.110	ER16	34	21	M22 x 1,5
205.02.116	ER25	50	22	M32 x 1,5
205.02.120	ER32	63	23	M40 x 1,5
205.02.126	ER40	78	28	M50 x 1,5

- Durch Verstellung von Schrauben, eine Rundlaufgenauigkeit von 0,001 mm möglich.
- By adjusting screws, runout precision of 0.001 mm is possible.

Spannschlüssel ER
Wrench ER

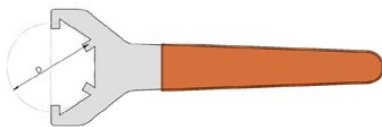

Art.-Nr.	Bezeichnung Description	D
202.02.110	ER16	32
202.02.113	ER20	35
202.02.116	ER25	42
202.02.120	ER32	50
202.02.126	ER40	63



Art.-Nr.	Bezeichnung Description	D
202.2M.105	ER 8 Mini	12
202.2M.107	ER 11 Mini	16
202.2M.110	ER 16 Mini	22
202.2M.113	ER 20 Mini	28
202.2M.116	ER 25 Mini	35



Art.-Nr.	Bezeichnung Description	D	L	Nm	Nm
202.15.305	ER 8 Mini	12	117	8	-
202.15.307	ER 11 Mini	16	120	18	-
202.15.310	ER 16 Mini	22	175	28	-
202.15.410	ER 16	32	380	25-35	45-55
202.15.413	ER 20	35	380	30-40	60-70
202.15.416	ER 25	42	400	45-55	80-90
202.15.420	ER 32	50	400	65-70	120-130
202.15.426	ER 40	63	450	110-120	190-200

Synchro-Gewindeschneidfutter mit Zylinderschaft
Synchronized Tapping Chuck With Cylindrical Shaft

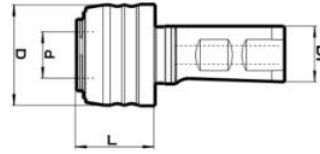

Art.-Nr.	D1	Spannbereich Clamping Range	Spannzangentyp Collet Type	L	D	D
625.26.112	25	M3-M12	ER16	35	43	20
625.26.120	25	M6-M20	ER25	56	60	32
640.26.136	40	M14-M36	ER40	80	87	50

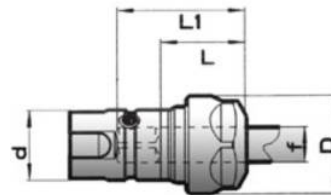

Art.-Nr.	D1	d	D	L	L1
126.02.110	M3-M12 ER16	20	28	24	37
126.02.116	M6-M20 ER25	32	42	28	52
126.02.126	M14-M33 ER40	50	63	32	75

Gewindeschneidfutter mit Zylinderschaft
Tapping Chuck with Cylindrical Shaft



Art.-Nr.	Bezeichnung Description	d	D	D1	L	L1
620.16.120	Ø20 M3-M12	19	38	20	50	41
620.16.125	Ø25 M3-M12	19	38	25	56	41
620.16.132	Ø32 M3-M12	19	38	32	61	41
620.16.140	Ø40 M3-M12	19	38	40	72	41
620.16.225	Ø25 M5-M20	31	55	25	56	63
620.16.232	Ø32 M5-M20	31	55	32	61	63
620.16.240	Ø40 M5-M20	31	55	40	72	63

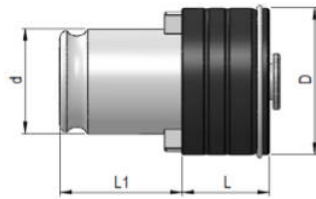

Art.-Nr.	Bezeichnung Description	d	D	L	L1	M	Schächt Shank	□	DIN
116.11.3527	KTE1 3,5 M3	19	32	25	21,5	M 3	3,5	2,7	371
116.11.4534	KTE1 4,5 M4	19	32	25	21,5	M 4	4,5	3,4	371
116.11.649	KTE1 6 M5	19	32	25	21,5	M 5	6	4,9	371
116.11.649	KTE1 6 M6	19	32	25	21,5	M 6	6	4,9	371
116.11.862	KTE1 8 M8	19	32	25	21,5	M 8	8	6,2	371
116.11.755	KTE1 7 M10	19	32	25	21,5	M10	7	5,5	376
116.11.108	KTE1 10 M10	19	32	25	21,5	M10	10	8	371
116.11.97	KTE1 9 M12	19	32	25	21,5	M12	9	7	376
116.11.119	KTE1 11 M14	19	32	25	21,5	M14	11	9	376
116.12.649	KTE2 6 M6	31	50	34	35	M6	6	4,9	371
116.12.862	KTE2 8 M8	31	50	34	35	M8	8	6,2	371
116.12.755	KTE2 7 M10	31	50	34	35	M10	7	5,5	376
116.12.108	KTE2 10 M10	31	50	34	35	M10	10	8	371
116.12.97	KTE2 9 M12	31	50	34	35	M12	9	7	376
116.12.119	KTE2 11 M14	31	50	34	35	M14	11	9	376
116.12.129	KTE2 12 M16	31	50	34	35	M16	12	9	376
116.12.1411	KTE2 14 M18	31	50	34	35	M18	14	11	376
116.12.1612	KTE2 16 M20	31	50	34	35	M20	16	12	376
116.12.1814	KTE2 18 M24	31	50	34	35	M24	18	14,5	376



STAR 331-50-
ER16

SV12, ECAS12/20, SB12/20R,
SB16D/E, SR20J/JN/RII-IV, SV20
SW20, SV32, SV32J, SV32JII
SR32, SR32J/JN, SV38R



STAR 571-55-
ER16

ECAS12/20, SB12/20R, SR20J/
JN/RII-IV, SW20, ECAS32T,
SV38R



STAR-OR1-61-
ER16
Back-working

SB12/20R, SW12RII, SR20RIV,
SW20: SV20R: SR38

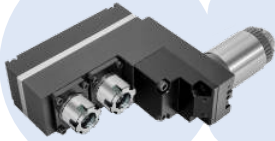

STAR 541-51-
ER16
ER16 / 2-2 fach

SB16D/E, SR20J/
JN/RII-IV; SB12/20R

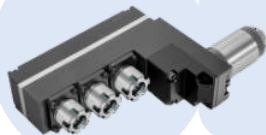

STAR 661-51-
ER16
ER16 /ER11

SB16D/E, SR20J/JN/ RII-IV;
SB12/20R

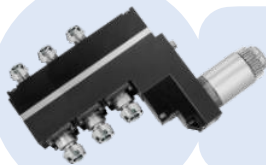

STAR 671-59-
ER16
ER16-ER11 / 3-3
fach

SR32J/JN

**Andere Maschinen
Other Machines**

Citizen

Tsugami

Tornos

Index / Traub

DMG Mori

Miyano

Maier

Hanwha

Nexturn

Nomurads

Goodway

Doosan

VAN

Ergomat

**Statischer Halter Bohrpilotenträger (STAR)
Static Tools (STAR)**





Gewindewirbeln
Whirling



Axial /Radial Bohr - und Fräswerkzeuge
Axial /Radial Driven Tools



Axial Bohr - und Fräswerkzeuge
Axial Driven Tools

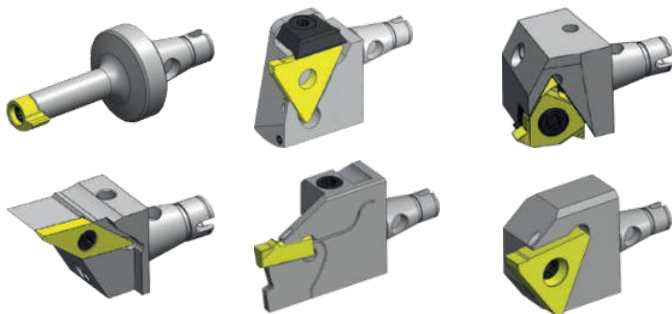

Adapter

Star

Citizen

Hanwha

VAN

Maier

DMG Mori

Tornos

Tsugami



Bimu Wendeschneidplattensysteme

- Auf Anfrage

Bimu Indexable Insert Systems

- Upon request

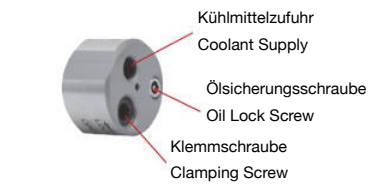

- Hydrodehn-Schnellspannsystem
- Hydro-expansion quick clamping system

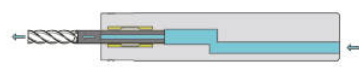

- Innenkühlung
- Internal Cooling

1 μ
micron

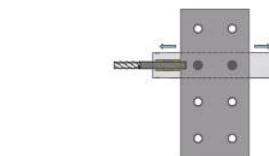
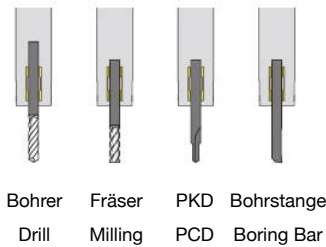

- Einfache Einstellung der axialen Länge
- Easy axial length adjustment



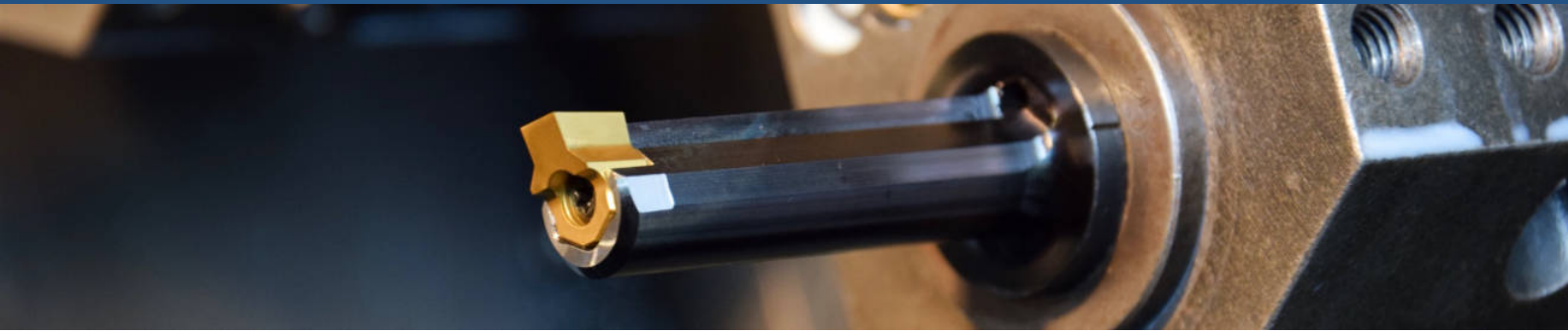

Längsnut, Sechskant, Vierkant, Keilwelle stoßen
Broach keyways, hexagon, square, spline profiles

2mm - 25mm Platten und Halter ab Lager

2mm - 25mm inserts and holders are available in stock

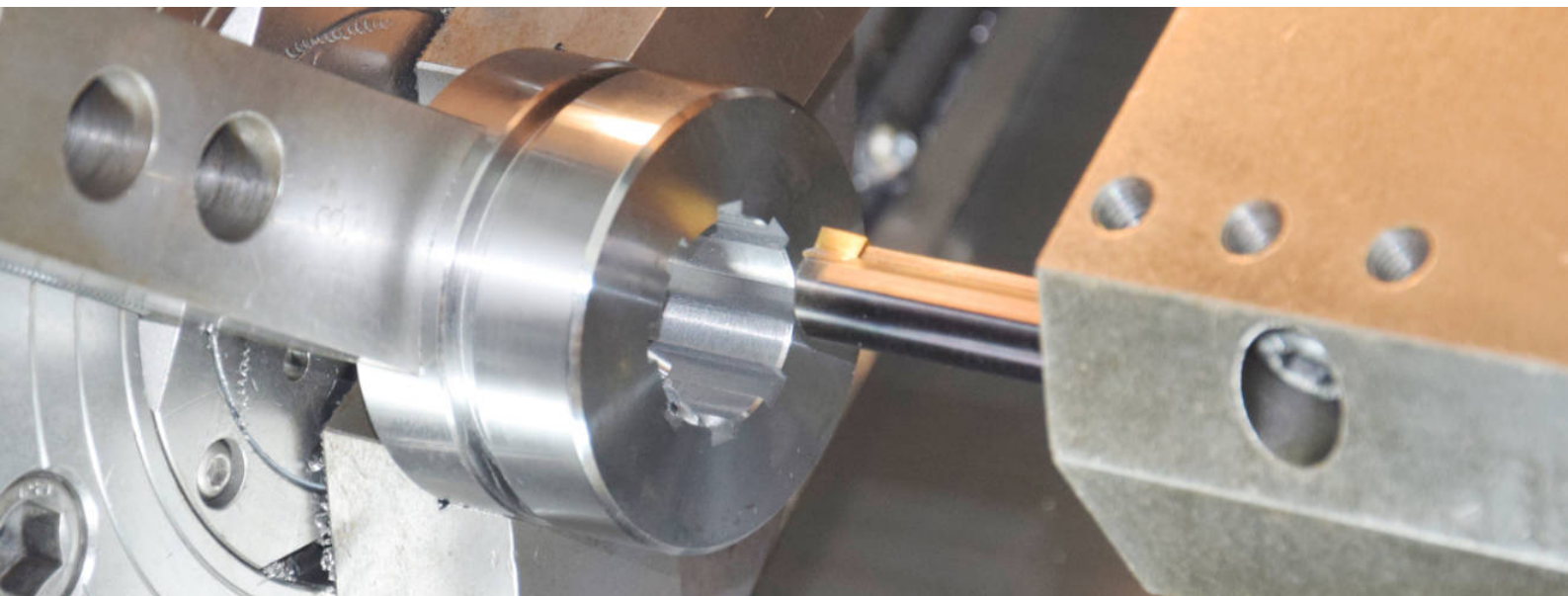

Die gängigen Modelle ab Lager

Common models from stock

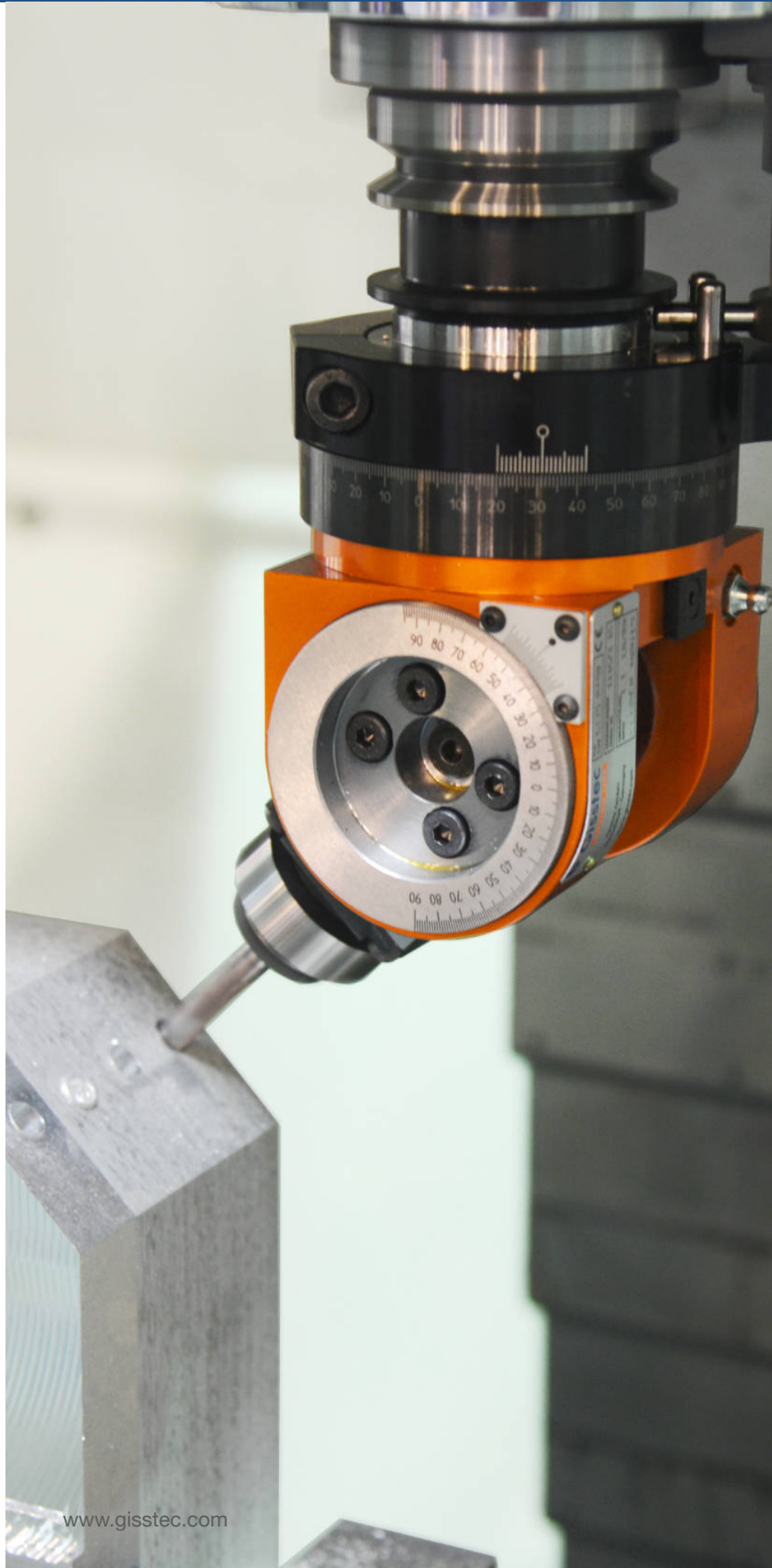



Gisstec GmbH
Ackerstr. 20
40233 Düsseldorf
Germany

☎ +49 211 2486 3666
info@gisstec.com

www.gisstec.com
shop.gisstec.com