

EISATEC[®]

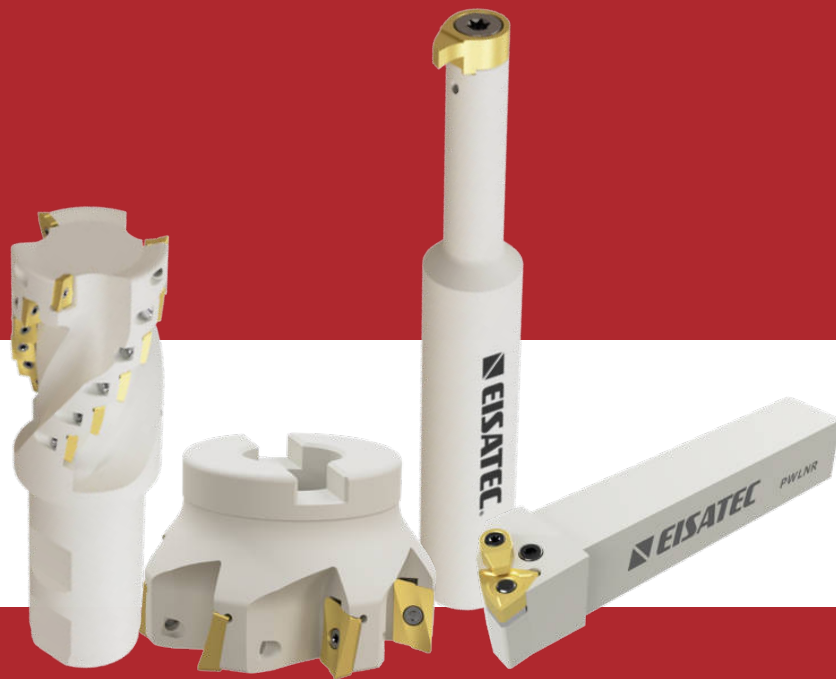

TRÄGERWERKZEUGE FÜR WENDESCHNEIDPLATTEN
INDEXABLE TOOL HOLDERS

www.eisatec.com



KLEMMHALTER - AUSSENBEARBEITUNG OD TURNING TOOLS

PRATZENKLEMMUNG
TOP CLAMPING



KNIEHEBELKLEMMUNG
LEVER LOCK CLAMPING

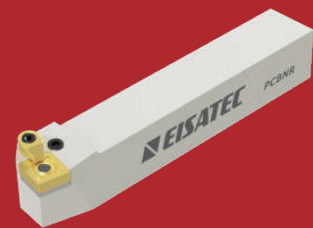

SCHRAUBENKLEMMUNG
SCREW CLAMPING

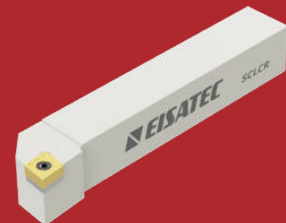

Klemmhalter mit Pratzenklemmung Turning Tool with Top Clamping



MTENN Anstellwinkel 60°

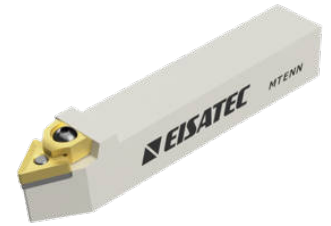
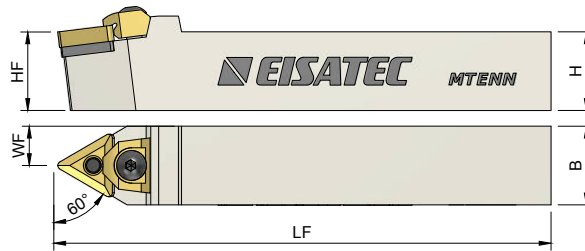
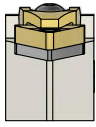

Artikelnummer Product Code	Bezeichnung Product Name	Abmessungen (mm) Dimensions (mm)				Wendeschneidplatte Insert	Spannpratze Wedge Clamp	Klemmschraube Clamp Screw	Unterlegplatte Shim	Stift Pin	Ring Ring	Scheibe Washer	Innensechskant- Schlüssel Allen Key
		HF=H	B	LF	WF								
6011177	MTENN 2020 K16	20	20	125	10	TNM. 1604	6211118	6211208	6211002	6211525	6211576	6211540	6211587
6011178	MTENN 2525 M16	25	25	150	12.5				6211005	6211527			
6011179	MTENN 3232 P16	32	32	170	16	TNM. 2204	6211120	6211005	6211527	6211576	6211540	6211587	
6011180	MTENN 2525 M22	25	25	150	12.5								
6011181	MTENN 3232 P22	32	32	170	16								
6011182	MTENN 4040 S22	40	40	250	20								

MWLN/L Anstellwinkel 95°

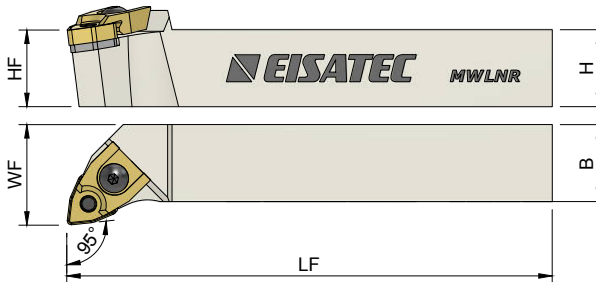

Artikelnummer Product Code	Bezeichnung Product Name	Abmessungen (mm) Dimensions (mm)				Wendeschneidplatte Insert	Spannpratze Wedge Clamp	Klemmschraube Clamp Screw	Unterlegplatte Shim	Stift Pin	Ring Ring	Scheibe Washer	Innensechskant- Schlüssel Allen Key
		HF=H	B	LF	WF								
6011201	MWLN/L 1616 H06	16	16	100	20	WNM. 0604	6211114	6211200	-	6211521	-	-	6211587
6011202	MWLN/L 2020 K06	20	20	125	25				6211023	6211527	6211576	6211540	
6011203	MWLN/L 2525 M06	25	25	150	32	WNM. 0804	6211117	6211216	6211023	6211527	6211576	6211540	6211587
6011204	MWLN/L 2020 K08	20	20	125	25								
6011205	MWLN/L 2525 M08	25	25	150	32								
6011206	MWLN/L 3232 P08	32	32	170	40								
6011207	MWLN/L 1616 H06	16	16	100	20	WNM. 0604	6211114	6211200	-	6211521	-	-	6211587
6011208	MWLN/L 2020 K06	20	20	125	25				6211023	6211527	6211576	6211540	
6011209	MWLN/L 2525 M06	25	25	150	32	WNM. 0804	6211117	6211216	6211023	6211527	6211576	6211540	6211587
6011210	MWLN/L 2020 K08	20	20	125	25								
6011211	MWLN/L 2525 M08	25	25	150	32								
6011212	MWLN/L 3232 P08	32	32	170	40								

PCBNR/L
Anstellwinkel 75°

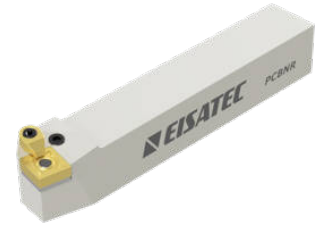
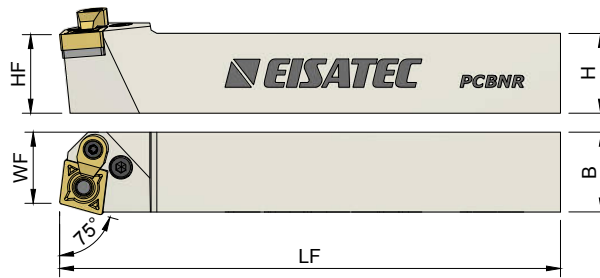

Artikelnummer Product Code	Bezeichnung Product Name	Abmessungen (mm) Dimensions (mm)				Wendeschnidplatte Insert	Kniehebel Lever	Kniehebelschraube Lever Screw	Unterlegplatte Shim	Schraube für Unterlegplatte Shim Spring	Spannpratze Wedge Clamp	Klemmschraube Clamp Screw	Innensechskant- Schlüssel Allen Key
		HF=H	B	LF	WF								
6011893	PCBNR 2020 K12C	20	20	125	17.5								
6011894	PCBNR 2525 M12C	25	25	150	22.5	CNM. 1204	6211501	6211305	6211018	6211511	6211125	6211385	6211587
6011895	PCBNR 3232 P12C	32	32	170	29.5								
6011896	PCBNR 2525 M16C	25	25	150	22	CNM. 1606	6211502	6211306	6211019	6211512			
6011897	PCBNR 3232 P16C	32	32	170	27						6211129	6211262	6211588
6011898	PCBNR 3232 P19C	32	32	170	27	CNM. 1906	6211503	6211307	6211020	6211513			
6011899	PCBNR 4040 S19C	40	40	250	37								
6011900	PCBNR 4040 S25C	40	40	250	37	CNM. 2509	6211504	6211308	6211021	6211514	6211124	6211264	6211589
6011902	PCBNL 2020 K12C	20	20	125	17.5								
6011903	PCBNL 2525 M12C	25	25	150	22.5	CNM. 1204	6211501	6211305	6211018	6211511	6211125	6211385	6211587
6011904	PCBNL 3232 P12C	32	32	170	29.5								
6011905	PCBNL 2525 M16C	25	25	150	22	CNM. 1606	6211502	6211306	6211019	6211512			
6011906	PCBNL 3232 P16C	32	32	170	27						6211129	6211262	6211588
6011907	PCBNL 3232 P19C	32	32	170	27	CNM. 1906	6211503	6211307	6211020	6211513			
6011908	PCBNL 4040 S19C	40	40	250	37								
6011909	PCBNL 4040 S25C	40	40	250	37	CNM. 2509	6211504	6211308	6211021	6211514	6211124	6211264	6211589

PCLNR/L
Anstellwinkel 95°

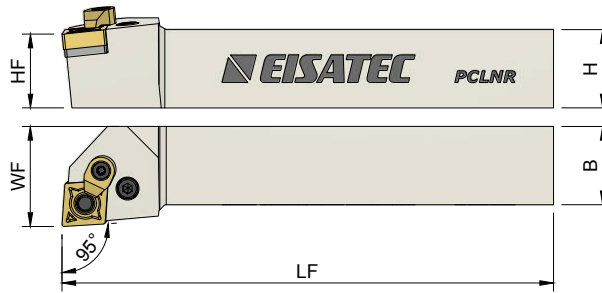

Artikelnummer Product Code	Bezeichnung Product Name	Abmessungen (mm) Dimensions (mm)				Wendeschneidplatte Insert	Kniehebel Lever	Kniehebelschraube Lever Screw	Unterlegplatte Shim	Schraube für Unterlegplatte Shim Spring	Spannpratze Wedge Clamp	Klemmschraube Clamp Screw	Innensechskant- Schlüssel Allen Key
		HF=H	B	LF	WF								
6011687	PCLNR 1616 H09	16	16	100	20	CNM. 0903	6211500	6211304	6211018	6211510	-	-	6211586
6011688	PCLNR 2020 K09	20	20	125	25								
6011689	PCLNR 2525 M09	25	25	150	32	CNM. 1204	6211501	6211305	6211018	6211511	6211125	6211385	6211587
6011690	PCLNR 1616 H12	16	16	100	20								
6011691	PCLNR 2020 K12C	20	20	125	25	CNM. 1606	6211502	6211306	6211019	6211512	6211129	6211262	6211588
6011692	PCLNR 2525 M12C	25	25	150	32								
6011693	PCLNR 3232 P12C	32	32	170	40	CNM. 1906	6211503	6211307	6211020	6211513	6211124	6211264	6211589
6011694	PCLNR 2525 M16C	25	25	150	32								
6011695	PCLNR 3232 P16C	32	32	170	40	CNM. 2509	6211504	6211308	6211021	6211514	6211124	6211264	6211589
6011696	PCLNR 2525 M19C	25	25	150	32								
6011697	PCLNR 3232 P19C	32	32	170	40	CNM. 0903	6211500	6211304	6211018	6211510	-	-	6211586
6011698	PCLNR 4040 S19C	40	40	250	50								
6011699	PCLNR 4040 S25C	40	40	250	50	CNM. 1204	6211501	6211305	6211018	6211511	6211125	6211385	6211587
6011700	PCLNR 5050 S25C	50	50	250	60								
6011701	PCLNL 1616 H09	16	16	100	20	CNM. 1606	6211502	6211306	6211019	6211512	6211129	6211262	6211588
6011702	PCLNL 2020 K09	20	20	125	25								
6011703	PCLNL 2525 M09	25	25	150	32	CNM. 1906	6211503	6211307	6211020	6211513	6211124	6211264	6211589
6011704	PCLNL 1616 H12	16	16	100	20								
6011705	PCLNL 2020 K12C	20	20	125	25	CNM. 2509	6211504	6211308	6211021	6211514	6211124	6211264	6211589
6011706	PCLNL 2525 M12C	25	25	150	32								
6011707	PCLNL 3232 P12C	32	32	170	40	CNM. 0903	6211500	6211304	6211018	6211510	-	-	6211586
6011708	PCLNL 2525 M16C	25	25	150	32								
6011709	PCLNL 3232 P16C	32	32	170	40	CNM. 1204	6211501	6211305	6211018	6211511	6211125	6211385	6211587
6011710	PCLNL 2525 M19C	25	25	150	32								
6011711	PCLNL 3232 P19C	32	32	170	40	CNM. 1606	6211502	6211306	6211019	6211512	6211129	6211262	6211588
6011712	PCLNL 4040 S19C	40	40	250	50								
6011713	PCLNL 4040 S25C	40	40	250	50	CNM. 1906	6211503	6211307	6211020	6211513	6211124	6211264	6211589
6011714	PCLNL 5050 S25C	50	50	250	60								

PDJNR/L
Anstellwinkel 95°

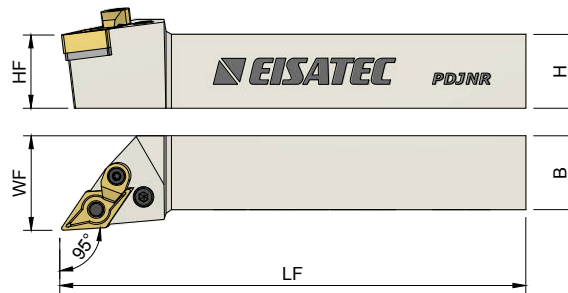
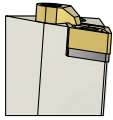

Artikelnummer Product Code	Bezeichnung Product Name	Abmessungen (mm) Dimensions (mm)				Wendeschneidplatte Insert	Kniehebel Lever	Kniehebelschraube Lever Screw	Unterlegplatte Shim	Schraube für Unterlegplatte Shim Spring	Spannpratze Wedge Clamp	Klemmschraube Clamp Screw	Innensechskant- Schlüssel Allen Key
		HF=H	B	LF	WF								
6011727	PDJNR 1616 H11	16	16	100	20								
6011728	PDJNR 2020 K11	20	20	125	25	DNM. 1104	6211500	6211304	6211038	6211510	-	-	6211586
6011729	PDJNR 2525 M11	25	25	150	32								
6011730	PDJNR 2020 K15C	20	20	125	25								
6011731	PDJNR 2525 M15C	25	25	150	32								
6011732	PDJNR 3232 P15C	32	32	170	40	DNM. 1506	6211505	6211305	6211039	6211511	6211125	6211385	6211587
6011733	PDJNR 4040 S15C	40	40	250	50								
6011734	PDJNL 1616 H11	16	16	100	20								
6011735	PDJNL 2020 K11	20	20	125	25	DNM. 1104	6211500	6211304	6211038	6211510	-	-	6211586
6011736	PDJNL 2525 M11	25	25	150	32								
6011737	PDJNL 2020 K15C	20	20	125	25								
6011738	PDJNL 2525 M15C	25	25	150	32								
6011739	PDJNL 3232 P15C	32	32	170	40	DNM. 1506	6211505	6211305	6211039	6211511	6211125	6211385	6211587
6011740	PDJNL 4040 S15C	40	40	250	50								

PSSNR/L
Anstellwinkel 45°

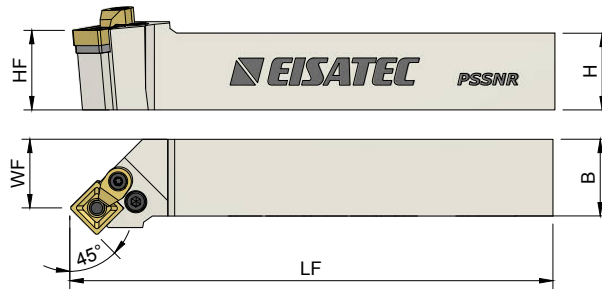

Artikelnummer Product Code	Bezeichnung Product Name	Abmessungen (mm) Dimensions (mm)				Wendeschneidplatte Insert	Kniehebel Lever	Kniehebelschraube Lever Screw	Unterlegplatte Shim	Schraube für Unterlegplatte Shim Spring	Spannpratze Wedge Clamp	Klemmschraube Clamp Screw	Innensechskant- Schlüssel Allen Key
		HF=H	B	LF	WF								
6011778	PSSNR 1616 H09	16	16	100	20						-	-	
6011779	PSSNR 2020 K09	20	20	125	25	SNM. 0903	6211500	6211304	6211030	6211510	-	-	6211586
6011780	PSSNR 2020 K12C	20	20	125	25	SNM. 1204	6211501	6211305	6211032	6211511	6211125	6211385	6211587
6011781	PSSNR 2525 M12C	25	25	150	32								
6011782	PSSNR 3232 P12C	32	32	170	40	SNM. 1506	6211502	6211306	6211033	6211512	6211129	6211262	6211588
6011783	PSSNR 3232 P15C	32	32	170	40								
6011784	PSSNR 3232 P19C	32	32	170	40	SNM. 1906	6211503	6211307	6211034	6211513			
6011785	PSSNR 4040 S19C	40	40	250	50	SNM. 2509	6211504	6211308	6211035	6211514	6211124	6211264	6211589
6011786	PSSNR 4040 S25C	40	40	250	50								
6011787	PSSNL 1616 H09	16	16	100	20	SNM. 0903	6211500	6211304	6211030	6211510	-	-	6211586
6011788	PSSNL 2020 K09	20	20	125	25	SNM. 1204	6211501	6211305	6211032	6211511	6211125	6211385	6211587
6011789	PSSNL 2020 K12C	20	20	125	25								
6011790	PSSNL 2525 M12C	25	25	150	32	SNM. 1506	6211502	6211306	6211033	6211512	6211129	6211262	6211588
6011791	PSSNL 3232 P12C	32	32	170	40								
6011792	PSSNL 3232 P15C	32	32	170	40	SNM. 1906	6211503	6211307	6211034	6211513			
6011793	PSSNL 3232 P19C	32	32	170	40	SNM. 2509	6211504	6211308	6211035	6211514	6211124	6211264	6211589
6011794	PSSNL 4040 S19C	40	40	250	50								
6011795	PSSNL 4040 S25C	40	40	250	50								

Klemmhalter mit Kniehebelklemmung Turning Tool with Lever Lock Clamping



PTGNR/L Anstellwinkel 90°

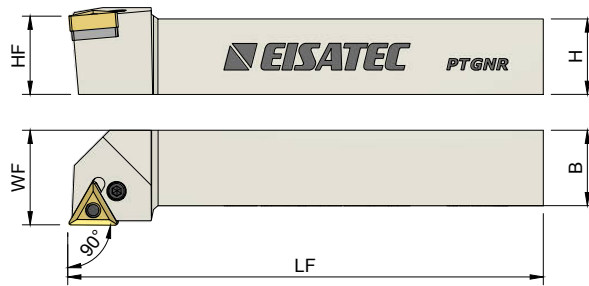
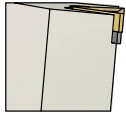

Artikelnummer Product Code	Bezeichnung Product Name	Abmessungen (mm) Dimensions (mm)				Wendeschneidplatte Insert	Kniehebel Lever	Kniehebelschraube Lever Screw	Unterlegplatte Shim	Schraube für Unterlegplatte Shim Spring	Spannpratze Wedge Clamp	Klemmschraube Clamp Screw	Innensechskant- Schlüssel Allen Key
		HF=H	B	LF	WF								
6011850	PTGNR 1616 H16	16	16	100	20	TNM. 1604	6211500	6211300	6211004	6211510	6211125	6211385	6211586
6011851	PTGNR 2020 K16	20	20	125	25			6211304					
6011852	PTGNR 2525 M16	20	20	125	25	TNM. 2204	6211501	6211305	6211005	6211511			6211587
6011853	PTGNR 2525 M22C	25	25	150	32								
6011854	PTGNR 3232 P22C	32	32	170	40								
6011860	PTGNL 1616 H16	16	16	100	20	TNM. 1604	6211500	6211300	6211004	6211510	6211125	6211385	6211586
6011861	PTGNL 2020 K16	20	20	125	25			6211304					
6011862	PTGNL 2525 M16	20	20	125	25	TNM. 2204	6211501	6211305	6211005	6211511			6211587
6011863	PTGNL 2525 M22C	25	25	150	32								
6011864	PTGNL 3232 P22C	32	32	170	40								

PWLNLR/L Anstellwinkel 95°

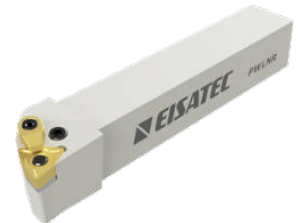
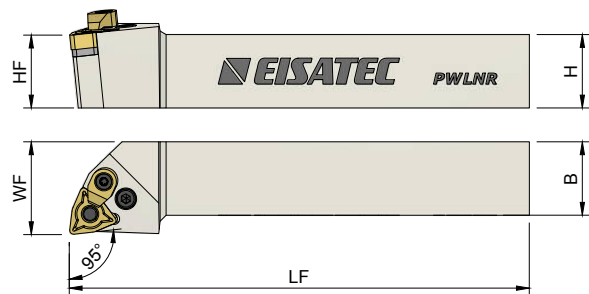
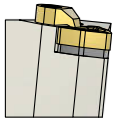

Artikelnummer Product Code	Bezeichnung Product Name	Abmessungen (mm) Dimensions (mm)				Wendeschneidplatte Insert	Kniehebel Lever	Kniehebelschraube Lever Screw	Unterlegplatte Shim	Schraube für Unterlegplatte Shim Spring	Spannpratze Wedge Clamp	Klemmschraube Clamp Screw	Innensechskant- Schlüssel Allen Key
		HF=H	B	LF	WF								
6011834	PWLNLR 1616 H06	16	16	100	20	WNM. 0604	6211500	6211304	6211024	6211510	-	-	6211586
6011835	PWLNLR 2020 K06	20	20	125	25								
6011836	PWLNLR 2525 M06	25	25	150	32	WNM. 0804	6211501	6211305	6211023	6211511	6211125	6211385	6211587
6011837	PWLNLR 1616 H08	16	16	100	20								
6011838	PWLNLR 2020 K08C	20	20	125	25								
6011839	PWLNLR 2525 M08C	25	25	150	32								
6011840	PWLNLR 3232 P08C	32	32	170	40								
6011842	PWLNLR 1616 H06	16	16	100	20	WNM. 0604	6211500	6211304	6211024	6211510	-	-	6211586
6011843	PWLNLR 2020 K06	20	20	125	25								
6011844	PWLNLR 2525 M06	25	25	150	32	WNM. 0804	6211501	6211305	6211023	6211511	6211125	6211385	6211587
6011845	PWLNLR 1616 H08	16	16	100	20								
6011846	PWLNLR 2020 K08C	20	20	125	25								
6011847	PWLNLR 2525 M08C	25	25	150	32								
6011848	PWLNLR 3232 P08C	32	32	170	40								

SCLCR/L
Anstellwinkel 95°

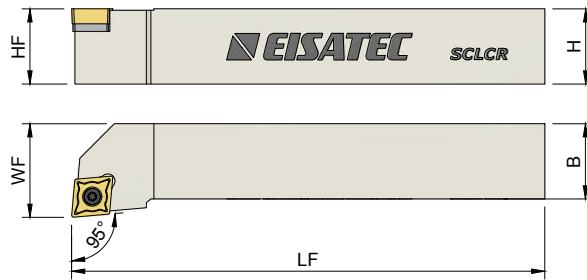
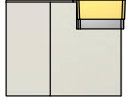

Artikelnummer Product Code	Bezeichnung Product Name	Abmessungen (mm) Dimensions (mm)				Wendeschneidplatte Insert	Klemmschraube Screw	Unterlegplatte Shim	Schraube für Unterlegplatte Shim Screw	Torx-Schlüssel Torx Key
		HF=H	B	LF	WF					
6011402	SCLCR 0808 E06	8	8	70	10	CCM. 0602	6211337	-	-	6211602
6011403	SCLCR 1010 E06	10	10	70	12					
6011404	SCLCR 1212 F06	12	12	80	16	CC.T 09T3	6211365	-	-	6211604
6011405	SCLCR 1010 E09	10	10	70	12					
6011406	SCLCR 1212 F09	12	12	80	16					
6011407	SCLCR 1616 H09	16	16	100	20	CC.T 1204	6211369	6211015	6211271	6211605
6011408	SCLCR 2020 K09	20	20	125	25					
6011409	SCLCR 2525 M09	25	25	150	32	CCM. 0602	6211337	-	-	6211602
6011410	SCLCR 1616 H12	16	16	100	20					
6011411	SCLCR 2020 K12	20	20	125	25	CC.T 09T3	6211365	-	-	6211604
6011412	SCLCR 2525 M12	25	25	150	32					
6011430	SCLCL 0808 E06	8	8	70	10					
6011431	SCLCL 1010 E06	10	10	70	12	CCM. 0602	6211337	-	-	6211602
6011432	SCLCL 1212 F06	12	12	80	16					
6011433	SCLCL 1010 E09	10	10	70	12	CC.T 09T3	6211365	-	-	6211604
6011434	SCLCL 1212 F09	12	12	80	16					
6011435	SCLCL 1616 H09	16	16	100	20					
6011436	SCLCL 2020 K09	20	20	125	25	CC.T 1204	6211369	6211015	6211271	6211605
6011437	SCLCL 2525 M09	25	25	150	32					
6011438	SCLCL 1616 H12	16	16	100	20	CCM. 0602	6211337	-	-	6211602
6011439	SCLCL 2020 K12	20	20	125	25					
6011440	SCLCL 2525 M12	25	25	150	32					

SDJCR/L
Anstellwinkel 93°

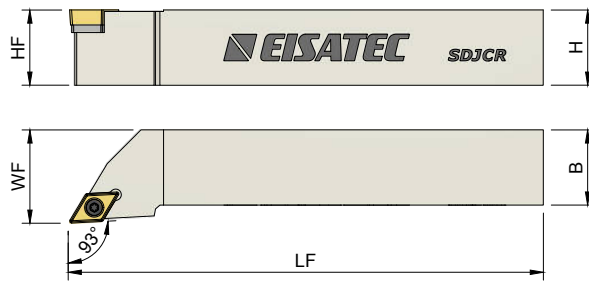
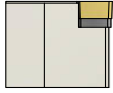

Artikelnummer Product Code	Bezeichnung Product Name	Abmessungen (mm) Dimensions (mm)				Wendeschneidplatte Insert	Klemmschraube Screw	Unterlegplatte Shim	Schraube für Unterlegplatte Shim Screw	Torx-Schlüssel Torx Key
		HF=H	B	LF	WF					
6011305	SDJCR 0808 E07	8	8	70	10	DC.T 0702	6211337	-	-	6211602
6011306	SDJCR 1010 E07	10	10	70	12					
6011307	SDJCR 1212 F07	12	12	80	16					
6011308	SDJCR 1616 H07	16	16	100	20					
6011309	SDJCR 1212 F11	12	12	80	16	DC.T 11T3	6211369	6211035	6211271	6211604
6011310	SDJCR 1616 H11	16	16	100	20					
6011311	SDJCR 2020 K11	20	20	125	25					
6011312	SDJCR 2525 M11	25	25	150	32					
6011313	SDJCR 3232 P11	32	32	170	40					
6011332	SDJCL 0808 E07	8	8	70	10	DC.T 0702	6211337	-	-	6211602
6011333	SDJCL 1010 E07	10	10	70	12					
6011334	SDJCL 1212 F07	12	12	80	16					
6011335	SDJCL 1616 H07	16	16	100	20					
6011336	SDJCL 1212 F11	12	12	80	16	DC.T 11T3	6211369	6211035	6211271	6211604
6011337	SDJCL 1616 H11	16	16	100	20					
6011338	SDJCL 2020 K11	20	20	125	25					
6011339	SDJCL 2525 M11	25	25	150	32					
6011340	SDJCL 3232 P11	32	32	170	40					

SDNCN
Anstellwinkel 90°

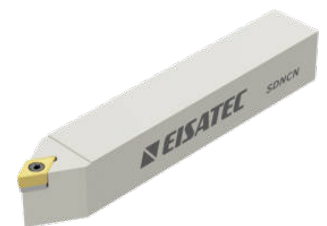
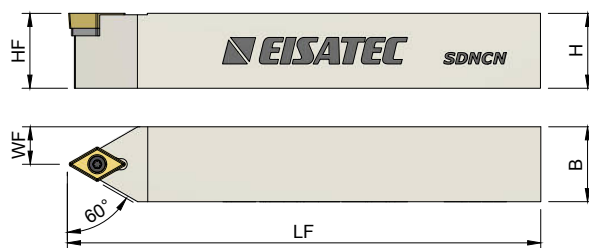

Artikelnummer Product Code	Bezeichnung Product Name	Abmessungen (mm) Dimensions (mm)				Wendeschneidplatte Insert	Klemmschraube Screw	Unterlegplatte Shim	Schraube für Unterlegplatte Shim Screw	Torx-Schlüssel Torx Key
		HF=H	B	LF	WF					
6011297	SDNCN 0808 E07	8	8	70	4	DC.T 0702	6211337	-	-	6211602
6011298	SDNCN 1010 E07	10	10	70	5					
6011299	SDNCN 1212 F07	12	12	80	6					
6011300	SDNCN 1616 H07	16	16	100	8					
6011301	SDNCN 1616 H11	16	16	100	8	DC.T 11T3	6211369	6211035	6211271	6211604
6011302	SDNCN 2020 K11	20	20	125	10					
6011303	SDNCN 2525 M11	25	25	150	12.5					
6011304	SDNCN 3232 P11	32	32	170	16					

SSSCR/L
Anstellwinkel 45°

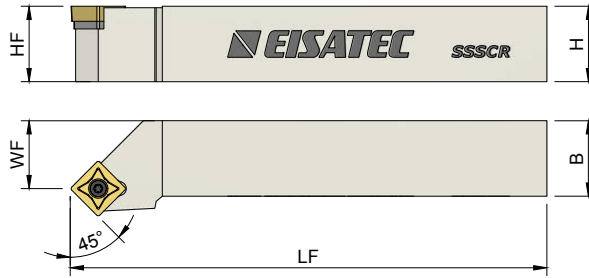
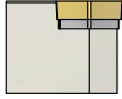

Artikelnummer Product Code	Bezeichnung Product Name	Abmessungen (mm) Dimensions (mm)				Wendeschneidplatte Insert	Klemmschraube Screw	Unterlegplatte Shim	Schraube für Unterlegplatte Shim Screw	Torx-Schlüssel Torx Key
		HF=H	B	LF	WF					
6011382	SSSCR 1212 F09	12	12	80	16	SC.T 09T3	6211367	-	-	6211604
6011391	SSSCR 1616 H09	16	16	100	20		6211369	6211029	6211271	
6011389	SSSCR 2020 K09	20	20	125	25	SC.T 1204	6211397	6211031	6211272	6211605
6011390	SSSCR 1616 H12	16	16	100	20		6211395		6211274	
6011388	SSSCR 2020 K12	20	20	125	25					
6011387	SSSCR 2525 M12	25	25	150	32					
6011392	SSSCL 1212 F09	12	12	80	16	SC.T 09T3	6211367	-	-	6211604
6011397	SSSCL 1616 H09	16	16	100	20		6211369	6211029	6211271	
6011398	SSSCL 2020 K09	20	20	125	25	SC.T 1204	6211397	6211031	6211272	6211605
6011401	SSSCL 1616 H12	16	16	100	20		6211395		6211274	
6011400	SSSCL 2020 K12	20	20	125	25					
6011399	SSSCL 2525 M12	25	25	150	32					

SVJBR/L
Anstellwinkel 93°

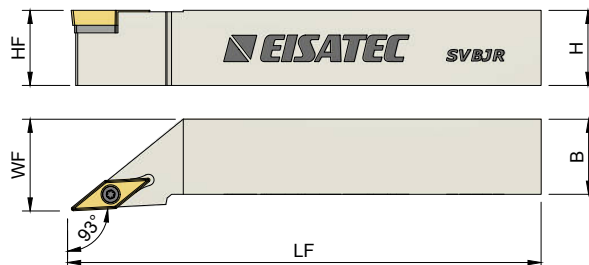

Artikelnummer Product Code	Bezeichnung Product Name	Abmessungen (mm) Dimensions (mm)				Wendeschneidplatte Insert	Klemmschraube Screw	Unterlegplatte Shim	Schraube für Unterlegplatte Shim Screw	Torx-Schlüssel Torx Key
		H=HF	B	LF	WF					
6011213	SVJBR 1212 F11	12	12	80	16	WB.T 1103	6211337	-	-	6211602
6011214	SVJBR1616 H11	16	16	100	20		6211368	6211273		
6011215	SVJBR 2020 K11	20	20	125	25	WB.T 1604	6211369	6211041	6211271	6211604
6011216	SVJBR 1616 H16	16	16	100	20					
6011217	SVJBR 2020 K16	20	20	125	25					
6011218	SVJBR 2525 M16	25	25	150	32					
6011219	SVJBR 3232 P16	32	32	170	40					
6011221	SVJBL 1212 F11	12	12	80	16	WB.T 1103	6211337	-	-	6211602
6011222	SVJBL 1616 H11	16	16	100	20		6211368	6211273		
6011223	SVJBL 2020 K11	20	20	125	25	WB.T 1604	6211369	6211041	6211271	6211604
6011224	SVJBL 1616 H16	16	16	100	20					
6011225	SVJBL 2020 K16	20	20	125	25					
6011226	SVJBL 2525 M16	25	25	150	32					
6011226	SVJBL 3232 P16	32	32	170	40					

SVVBN

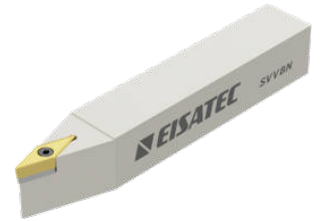
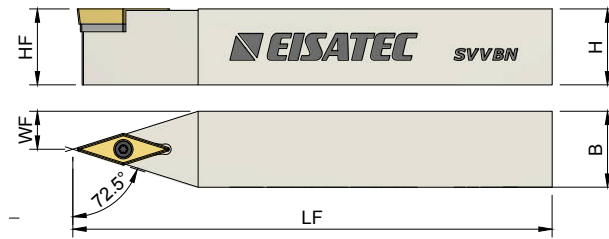
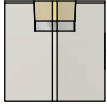

Artikelnummer Product Code	Bezeichnung Product Name	Abmessungen (mm) Dimensions (mm)				Wendeschneidplatte Insert	Klemmschraube Screw	Unterlegplatte Shim	Schraube für Unterlegplatte Shim Screw	Torx-Schlüssel Torx Key
		H=HF	B	LF	WF					
6011241	SVVBN 1212 F11	12	12	80	6			-	-	
6011242	SVVBN 1616 H11	16	16	100	8	WB.T 1103	6211337	-	-	6211602
6011243	SVVBN 2020 K11	20	20	125	10					
6011244	SVVBN 2020 K16	20	20	125	10			6211041	6211271	6211604
6011245	SVVBN 2525 M16	25	25	150	12.5	WB.T 1604	6211369	6211041	6211271	6211604
6011246	SVVBN 3232 P16	32	32	170	16					

SVVCN

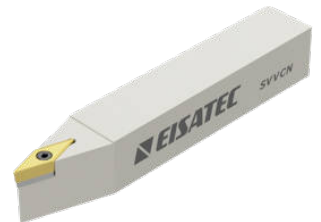
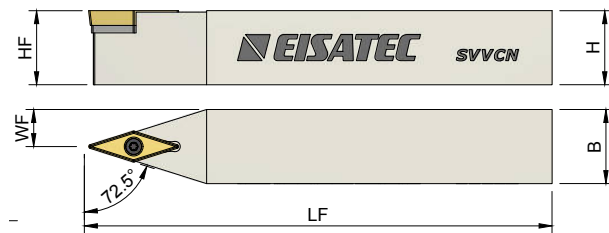
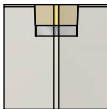

Artikelnummer Product Code	Bezeichnung Product Name	Abmessungen (mm) Dimensions (mm)				Wendeschneidplatte Insert	Klemmschraube Screw	Unterlegplatte Shim	Schraube für Unterlegplatte Shim Screw	Torx-Schlüssel Torx Key
		HF=H	B	LF	WF					
6011291	SVVCN 1212 F11	12	12	80	6			-	-	
6011292	SVVCN 1616 H11	16	16	100	8	VC.T 1103	6211337	-	-	6211602
6011293	SVVCN 2020 K11	20	20	125	10					
6011294	SVVCN 2020 K16	20	20	125	10			6211041	6211271	6211604
6011295	SVVCN 2525 M16	25	25	150	12.5	VC.T 1604	6211369	6211041	6211271	6211604
6011296	SVVCN 3232 P16	32	32	170	16					

SVJCR/L
Anstellwinkel 93°

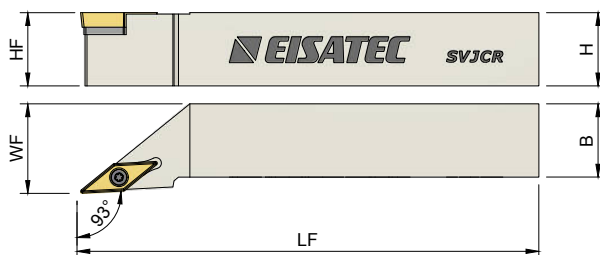

Artikelnummer Product Code	Bezeichnung Product Name	Abmessungen (mm) Dimensions (mm)				Wendeschneidplatte Insert	Klemmschraube Screw	Unterlegplatte Shim	Schraube für Unterlegplatte Shim Screw	Torx-Schlüssel Torx Key
		H=HF	B	LF	WF					
6011247	SVJCR 1212 F11	12	12	80	16	VC.T 1103	6211337	-	-	6211602
6011248	SVJCR 1616 H11	16	16	100	20					
6011249	SVJCR 2020 K11	20	20	125	25					
6011250	SVJCR 2525 M11	25	25	150	32	VC.T 1604	6211367	6211041	6211271	6211604
6011251	SVJCR 1212 F16	12	12	80	16					
6011252	SVJCR 2020 K16	20	20	125	25					
6011253	SVJCR 2525 M16	25	25	150	32					
6011254	SVJCR 3232 P16	32	32	170	40					
6011255	SVJCL 1212 F11	12	12	80	16	VC.T 1103	6211337	-	-	6211602
6011256	SVJCL 1616 H11	16	16	100	20					
6011257	SVJCL 2020 K11	20	20	125	25					
6011258	SVJCL 2525 M11	25	25	150	32	VC.T 1604	6211367	6211041	6211271	6211604
6011259	SVJCL 1212 F16	12	12	80	16					
6011260	SVJCL 2020 K16	20	20	125	25					
6011261	SVJCL 2525 M16	25	25	150	32					
6011262	SVJCL 3232 P16	32	32	170	40					

TCKNR/L
Anstellwinkel 75°

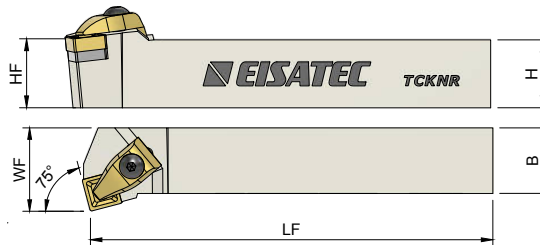

Artikelnummer Product Code	Bezeichnung Product Name	Abmessungen (mm) Dimensions (mm)				Wendeschneidplatte Insert	Spannpratze Wedge Clamp	Klemmschraube Clamp Screw	Unterlegplatte Shim	Schraube für Unterlegplatte Shim Screw	Ring Ring	Scheibe Washer	Innensechskant- Schlüssel Allen Key
		HF=H	B	LF	WF								
6011145	TCKNR 2020 K12	20	20	125	25	CNM. 1204	6211101	6211208	6211018	6211268	6211576	6211540	6211587
6011146	TCKNR 2525 M12	25	25	150	32								
6011147	TCKNR 3232 P12	32	32	170	40								
6011148	TCKNR 2525 M16	25	25	150	32	CNM. 1606	6211103	6211207	6211019	6211262	6211577	6211541	6211588
6011149	TCKNR 3232 P16	32	32	170	40								
6011150	TCKNL 2020 K12	20	20	125	25								
6011151	TCKNL 2525 M12	25	25	150	32	CNM. 1204	6211101	6211208	6211018	6211268	6211576	6211540	6211587
6011152	TCKNL 3232 P12	32	32	170	40								
6011153	TCKNL 2525 M16	25	25	150	32								
6011154	TCKNL 3232 P16	32	32	170	40	CNM. 1606	6211103	6211207	6211019	6211262	6211577	6211541	6211588

TCLNR/L
Anstellwinkel 95°

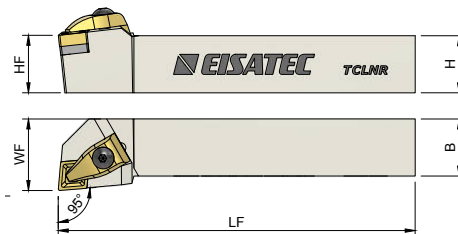

Artikelnummer Product Code	Bezeichnung Product Name	Abmessungen (mm) Dimensions (mm)				Wendeschneidplatte Insert	Spannpratze Wedge Clamp	Klemmschraube Clamp Screw	Unterlegplatte Shim	Schraube für Unterlegplatte Shim Screw	Ring Ring	Scheibe Washer	Innensechskant- Schlüssel Allen Key
		HF=H	B	LF	WF								
6011049	TCLNR 2020 K12	20	20	125	25	CNM. 1204	6211101	6211208	6211018	6211261	6211576	6211540	6211587
6011050	TCLNR 2525 M12	25	25	150	32								
6011051	TCLNR 3232 P12	32	32	170	40								
6011052	TCLNR 4040 S12	40	40	250	50	CNM. 1606	6211103	6211207	6211019	6211262	6211577	6211541	6211588
6011053	TCLNR 5050 S12	50	50	250	63								
6011054	TCLNR 2525 M16	25	25	150	32								
6011055	TCLNR 3232 P16	32	32	170	40	CNM. 1204	6211101	6211208	6211018	6211261	6211576	6211540	6211587
6011056	TCLNL 2020 K12	20	20	125	25								
6011057	TCLNL 2525 M12	25	25	150	32								
6011058	TCLNL 3232 P12	32	32	170	40	CNM. 1606	6211103	6211207	6211019	6211262	6211577	6211541	6211588
6011059	TCLNL 4040 S12	40	40	250	50								
6011060	TCLNL 5050 S12	50	50	250	63								
6011061	TCLNL 2525 M16	25	25	150	32	CNM. 1606	6211103	6211207	6211019	6211262	6211577	6211541	6211588
6011062	TCLNL 3232 P16	32	32	170	40								

TDJNR/L
Anstellwinkel 93°

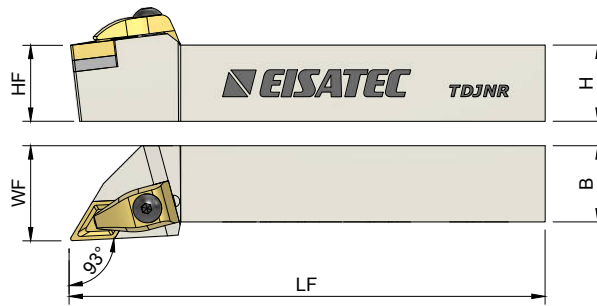
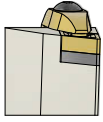

Artikelnummer Product Code	Bezeichnung Product Name	Abmessungen (mm) Dimensions (mm)				Wendeschneidplatte Insert	Spannpratze Wedge Clamp	Klemmschraube Clamp Screw	Unterlegplatte Shim	Schraube für Unterlegplatte Shim Screw	Ring Ring	Scheibe Washer	Innensechskant- Schlüssel Allen Key
		HF=H	B	LF	WF								
6011001	TDJNR 1616 H11	16	16	100	20								
6011002	TDJNR 2020 K11	20	20	125	25	DNM. 1104	6211100	6211201	6211035	6211268	-		
6011003	TDJNR 2525 M11	25	25	150	32								
6011004	TDJNR 2020 K15	20	20	125	25	DNM. 1506	6211101	6211208	6211039	6211261	6211576	6211540	6211587
6011005	TDJNR 2525 M15	25	25	150	32								
6011006	TDJNR 3232 P15	32	32	170	40	DNM. 1504	6211101	6211208	6211039	6211261	6211576	6211540	6211587
6011007	TDJNR 4040 S15	40	40	250	50								
6011008	TDJNR 2020 K1504	20	20	125	25								
6011009	TDJNR 2525 M1504	25	25	150	32	DNM. 1504	6211101	6211208	6211039	6211261	6211576	6211540	6211587
6011010	TDJNR 3232 P1504	32	32	170	40								
6011011	TDJNR 4040 S1504	40	40	250	50								
6011013	TDJNL 1616 H11	16	16	100	20								
6011014	TDJNL 2020 K11	20	20	125	25	DNM. 1104	6211100	6211201	6211035	6211268	-		
6011015	TDJNL 2525 M11	25	25	150	32								
6011016	TDJNL 2020 K15	20	20	125	25	DNM. 1506	6211101	6211208	6211039	6211261	6211576	6211540	6211587
6011017	TDJNL 2525 M15	25	25	150	32								
6011018	TDJNL 3232 P15	32	32	170	40	DNM. 1504	6211101	6211208	6211039	6211261	6211576	6211540	6211587
6011019	TDJNL 4040 S15	40	40	250	50								
6011020	TDJNL 2020 K1504	20	20	125	25								
6011021	TDJNL 2525 M1504	25	25	150	32	DNM. 1504	6211101	6211208	6211039	6211261	6211576	6211540	6211587
6011022	TDJNL 4040 S1504	40	40	250	50								

TVHNR/L

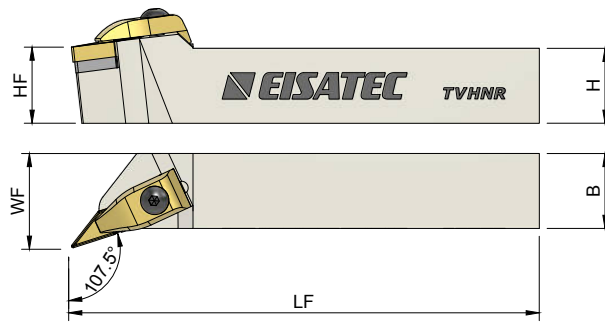

Artikelnummer Product Code	Bezeichnung Product Name	Abmessungen (mm) Dimensions (mm)				Wendeschneidplatte Insert	Spannpratze Wedge Clamp	Klemmschraube Clamp Screw	Unterlegplatte Shim	Schraube für Unterlegplatte Shim Screw	Ring Ring	Scheibe Washer	Innensechskant- Schlüssel Allen Key
		HF=H	B	LF	WF								
6011099	TVHNR 2020 K16	20	20	125	25	VNM. 1604	6211102	6211208	6211041	6211268	6211576	6211540	6211587
6011100	TVHNR 2525 M16	25	25	150	32								
6011101	TVHNR 3232 P16	32	32	170	40								
6011102	TVHNL 2020 K16	20	20	125	25	VNM. 1604	6211102	6211208	6211041	6211268	6211576	6211540	6211587
6011103	TVHNL 2525 M16	25	25	150	32								
6011104	TVHNL 3232 P16	32	32	170	40								

TVJNR/L
Anstellwinkel 93°

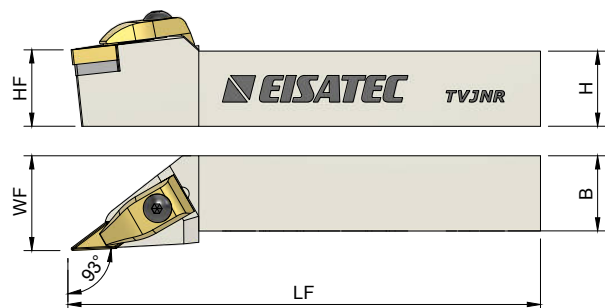

Artikelnummer Product Code	Bezeichnung Product Name	Abmessungen (mm) Dimensions (mm)				Wendeschneidplatte Insert	Spannpratze Wedge Clamp	Klemmschraube Clamp Screw	Unterlegplatte Shim	Schraube für Unterlegplatte Shim Screw	Ring Ring	Scheibe Washer	Innensechskant- Schlüssel Allen Key
		HF=H	B	LF	WF								
6011092	TVJNR 2020 K16	20	20	125	25	VNM. 1604	6211102	6211208	6211041	6211268	6211576	6211540	6211587
6011093	TVJNR 2525 M16	25	25	150	32								
6011094	TVJNR 3232 P16	32	32	170	40								
6011095	TVJNL 2020 K16	20	20	125	25	VNM. 1604	6211102	6211208	6211041	6211268	6211576	6211540	6211587
6011096	TVJNL 2525 M16	25	25	150	32								
6011097	TVJNL 3232 P16	32	32	170	40								

TWLNR/L
Anstellwinkel 95°

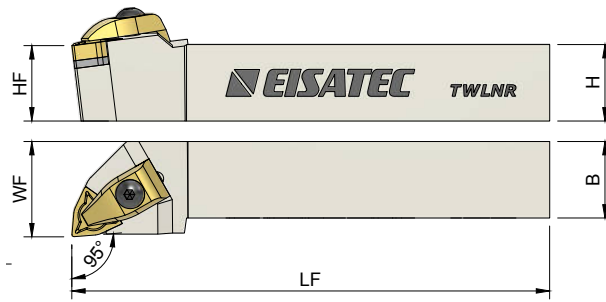

Artikelnummer Product Code	Bezeichnung Product Name	Abmessungen (mm) Dimensions (mm)				Wendeschneidplatte Insert	Spannpratze Wedge Clamp	Klemmschraube Clamp Screw	Unterlegplatte Shim	Schraube für Unterlegplatte Shim Screw	Ring Ring	Scheibe Washer	Innensechskant- Schlüssel Allen Key
		HF=H	B	LF	WF								
6011033	TWLNR 1616 H06	16	16	100	20						-		
6011034	TWLNR 2020 K06	20	20	125	25	WNM. 0604	6211100	6211201	6211024	6211260	-		
6011035	TWLNR 2525 M06	25	25	150	32								
6011036	TWLNR 2020 K08	20	20	125	25	WNM. 0804	6211101	6211208	6211023	6211261	6211576	6211540	6211587
6011037	TWLNR 2525 M08	25	25	150	32								
6011038	TWLNR 3232 P08	32	32	170	40								
6011039	TWLNR 4040 S08	40	40	250	50								
6011041	TWLNL 1616 H06	16	16	100	20								
6011042	TWLNL 2020 K06	20	20	125	25	WNM. 0604	6211100	6211201	6211024	6211260	-		
6011043	TWLNL 2525 M06	25	25	150	32								
6011044	TWLNL 2020 K08	20	20	125	25	WNM. 0804	6211101	6211208	6211023	6211261	6211576	6211540	6211587
6011045	TWLNL 2525 M08	25	25	150	32								
6011046	TWLNL 3232 P08	32	32	170	40								
6011047	TWLNL 4040 S08	40	40	250	50								



KLEMMHALTER FÜR INNENBEARBEITUNG ID TURNING TOOL

KNIEHEBELKLEMMUNG
LEVER LOCK CLAMPING



SCHRAUBENKLEMMUNG
SCREW CLAMPING



HARTMETALL-BOHRSTANGEN
CARBIDE BORING BARS

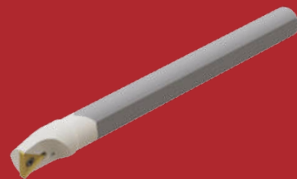

PCLNR/L
Anstellwinkel 95°

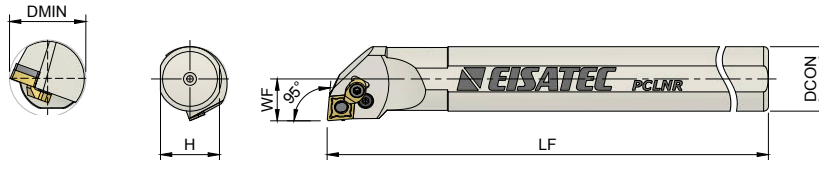

Artikelnummer Product Code	Bezeichnung Product Name	Abmessungen (mm) Dimensions (mm)					Wendeschneidplatte Insert	Kniehebel Lever	Kniehebelschraube Lever Screw	Unterlegplatte Shim	Schraube für Unterlegplatte Shim Spring	Spannpratze Wedge Clamp	Klemmschraube Clamp Screw	Innensechskant- Schlüssel Allen Key	
		DCON	H	LF	WF	DMIN									
6012807	S16P PCLNR 09	16	14,8	170	11	≥20	CNM. 0903	6211506	6211301	-	6211515	-	-	6211586	
6012808	S20R PCLNR 09	20	18,3	200	13	≥25		6211500	6211302	6211031	6211510				
6012809	S25S PCLNR 09	25	23	250	17	≥32			6211304						
6012810	S25S PCLNR 12C	25	23	250	17	≥32	CNM. 1204	6211501	6211303	6211018	6211511	6211125	6211385	6211587	
6012811	S32T PCLNR 12C	32	30	300	22	≥40			6211305						
6012812	S40U PCLNR 12C	40	37,5	350	27	≥50									
6012813	S50V PCLNR 12C	50	47	400	35	≥63	CNM. 1606	6211502	6211306	6211019	6211512	6211129	6211262	6211588	
6012814	S32T PCLNR 16C	32	30	300	22	≥40									
6012815	S40U PCLNR 16C	40	37,5	350	27	≥50									
6012816	S50V PCLNR 16C	50	47	400	35	≥63	CNM. 1906	6211503	6211307	6211020	6211513				
6012817	S40U PCLNR 19C	40	37,5	350	27	≥50									
6012818	S50V PCLNR 19C	50	47	400	35	≥63									
6012819	A20P PCLNR 09	20	18,3	170	13	≥25	CNM. 0903	6211500	-	6211031	6211510	-	-	6211588	
6012820	A25R PCLNR 12C	25	23	200	17	≥32			6211303						
6012821	A25S PCLNR 12C	25	23	250	17	≥32									
6012822	A32S PCLNR 12C	32	30	250	22	≥40	CNM. 1204	6211501	6211305	6211018	6211511	6211125	6211385	6211587	
6012823	A40T PCLNR 12C	40	37,5	300	27	≥50									
6012824	A50U PCLNR 12C	50	47	350	35	≥63									
6012825	A32S PCLNR 16C	32	30	250	22	≥40	CNM. 1606	6211502	6211306	6211019	6211512	6211129	6211262	6211588	
6012826	A40T PCLNR 16C	40	37,5	300	27	≥50									
6012827	A50U PCLNR 16C	50	47	350	35	≥63									
6012828	A40T PCLNR 19C	40	37,5	300	27	≥50	CNM. 1906	6211503	6211307	6211020	6211513				
6012829	A50U PCLNR 19C	50	47	350	35	≥63									
6012830	S16P PCLNL 09	16	14,8	170	11	≥20									CNM. 0903
6012831	S20R PCLNL 09	20	18,3	200	13	≥25	6211500	6211302	6211031	6211510					
6012832	S25S PCLNL 09	25	23	250	17	≥32		6211304							
6012833	S25S PCLNL 12C	25	23	250	17	≥32	CNM. 1204	6211501	6211303	6211018	6211511	6211125	6211385	6211587	
6012834	S32T PCLNL 12C	32	30	300	22	≥40			6211305						
6012835	S40U PCLNL 12C	40	37,5	350	27	≥50									
6012836	S50V PCLNL 12C	50	47	400	35	≥63	CNM. 1606	6211502	6211306	6211019	6211512	6211129	6211262	6211588	
6012837	S32T PCLNL 16C	32	30	300	22	≥40									
6012838	S40U PCLNL 16C	40	37,5	350	27	≥50									
6012839	S50V PCLNL 16C	50	47	400	35	≥63	CNM. 1906	6211503	6211307	6211020	6211513				
6012840	S40U PCLNL 19C	40	37,5	350	27	≥50									
6012841	S50V PCLNL 19C	50	47	400	35	≥63									
6012842	A20P PCLNL 09	20	18,3	170	13	≥25	CNM. 0903	6211500	-	6211031	6211510	-	-	6211588	
6012843	A25R PCLNL 12C	25	23	200	17	≥32			6211303						
6012844	A25S PCLNL 12C	25	23	250	17	≥32									
6012845	A32S PCLNL 12C	32	30	250	22	≥40	CNM. 1204	6211501	6211305	6211018	6211511	6211125	6211385	6211587	
6012846	A40T PCLNL 12C	40	37,5	300	27	≥50									
6012847	A50U PCLNL 12C	50	47	350	35	≥63									
6012848	A32S PCLNL 16C	32	30	250	22	≥40	CNM. 1606	6211502	6211306	6211019	6211512	6211129	6211262	6211588	
6012849	A40T PCLNL 16C	40	37,5	300	27	≥50									
6012850	A50U PCLNL 16C	50	47	350	35	≥63									
6012851	A40T PCLNL 19C	40	37,5	300	27	≥50	CNM. 1906	6211503	6211307	6211020	6211513				
6012851	A50U PCLNL 19C	50	47	350	35	≥63									

PDUNR/L
Anstellwinkel 93°

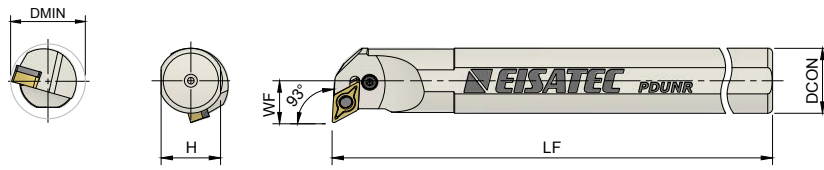

Artikelnummer Product Code	Bezeichnung Product Name	Abmessungen (mm) Dimensions (mm)					Wendeschneidplatte Insert	Kniehebel Lever	Kniehebelschraube Lever Screw	Unterlegplatte Shim	Schraube für Unterlegplatte Shim Spring	Innensechskant- Schlüssel Allen Key
		DCON	H	LF	WF	DMIN						
6012853	S20R PDUNR 11	20	18,3	200	13	≥25	DNM.1104	6211500	6211302	6211038	6211510	6211586
6012854	S25S PDUNR 11	25	23	250	17	≥32			6211304			
6012855	S25S PDUNR 15	25	23	250	19	≥32	DNM. 1506	6211505	6211303	6211039	6211511	6211587
6012856	S32T PDUNR 15	32	30	300	22	≥40			6211305			
6012857	S40U PDUNR 15	40	37,5	350	27	≥50			6211305			
6012858	S50V PDUNR 15	50	47	400	35	≥63	DNM.1104	6211500	6211302	6211038	6211510	6211586
6012859	A20P PDUNR 11	20	18,3	170	13	≥25			6211304			
6012860	A25R PDUNR 11	25	23	200	17	≥32			6211304			
6012861	A25S PDUNR 11	25	23	250	17	≥32			6211304			
6012862	A32S PDUNR 11	32	30	250	22	≥40			6211304			
6012863	A32S PDUNR 15	32	30	250	22	≥40			6211304			
6012864	A40T PDUNR 15	40	37,5	300	27	≥50	DNM.1506	6211505	6211305	6211039	6211511	6211587
6012865	A50U PDUNR 15	50	47	350	35	≥63			6211305			
6012866	S20R PDUNL 11	20	18,3	200	13	≥25	DNM.1104	6211500	6211302	6211038	6211510	6211586
6012867	S25S PDUNL 11	25	23	250	17	≥32			6211304			
6012868	S25S PDUNL 15	25	23	250	19	≥32	DNM. 1506	6211505	6211303	6211039	6211511	6211587
6012869	S32T PDUNL 15	32	30	300	22	≥40			6211305			
6012870	S40U PDUNL 15	40	37,5	350	27	≥50			6211305			
6012871	S50V PDUNL 15	50	47	400	35	≥63	DNM.1104	6211500	6211302	6211038	6211510	6211586
6012872	A20P PDUNL 11	20	18,3	170	13	≥25			6211304			
6012873	A25R PDUNL 11	25	23	200	17	≥32			6211304			
6012874	A32S PDUNL 11	32	30	250	22	≥40			6211304			
6012875	A32S PDUNL 15	32	30	250	22	≥40			6211304			
6012876	A40T PDUNL 15	40	37,5	300	27	≥50			6211304			
6012877	A50U PDUNL 15	50	47	350	35	≥63	DNM.1506	6211505	6211305	6211039	6211511	6211587
									6211305			

PWLNR/L
Anstellwinkel 95°

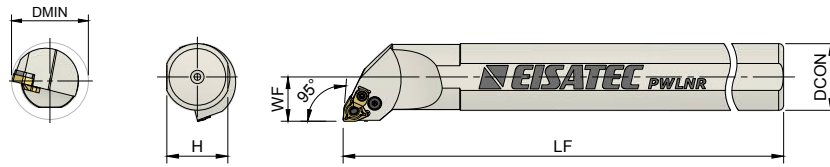

Artikelnummer Product Code	Bezeichnung Product Name	Abmessungen (mm) Dimensions (mm)					Wendeschneidplatte Insert	Kniehebel Lever	Kniehebel- Schraube Lever Screw	Unterleg-Platte Shim	Schraube für Unterlegplatte Shim Spring	Spannpratze Wedge Clamp	Klemm-Schraube Clamp Screw	Innensechskant- Schlüssel Allen Key
		DCON	H	LF	WF	DMIN								
6012919	S20R PWLNR 6	20	18,3	200	13	≥25	WNM. 0604	6211500	6211302	6211024	6211510	-	-	6211586
6012920	S25S PWLNR 6	25	23	250	17	≥32			6211304					
6012921	S32T PWLNR 6	32	30	300	22	≥40	WNM. 0804	6211501	6211305	6211023	6211511	6211125	6211385	6211587
6012922	S25S PWLNR 08C	25	23	250	17	≥32								
6012923	S32T PWLNR 08C	32	30	300	22	≥40								
6012924	S40U PWLNR 08C	40	37,5	350	27	≥50								
6012925	S50V PWLNR 08C	50	47	400	35	≥63								
6012926	A16M PWLNR 6	16	14,8	150	11	≥20	WNM. 0604	6211507	6211301	-	6211515	-	-	6211586
6012927	A20P PWLNR 6	20	18,3	170	13	≥25		6211500	6211302	6211024	6211510			
6012928	A25R PWLNR 6	25	23	200	17	≥32			6211304					
6012929	A32S PWLNR 6	32	30	250	22	≥40								
6012930	A40T PWLNR 6	40	37,5	300	27	≥50	WNM. 0804	6211501	6211305	6211023	6211511	6211125	6211385	6211587
6012931	A25R PWLNR 08C	25	23	200	17	≥32								
6012932	A32S PWLNR 08C	32	30	250	22	≥40								
6012933	A40T PWLNR 08C	40	37,5	300	27	≥50								
6012934	A50U PWLNR 08C	50	47	350	35	≥63								
6012935	S20R PWLNL 6	20	18,3	200	13	≥25	WNM. 0604	6211500	6211302	6211024	6211510	-	-	6211586
6012936	S25S PWLNL 6	25	23	250	17	≥32			6211304					
6012937	S32T PWLNL 6	32	30	300	22	≥40	WNM. 0804	6211501	6211305	6211023	6211511	6211125	6211385	6211587
6012938	S25S PWLNL 08C	25	23	250	17	≥32								
6012939	S32T PWLNL 08C	32	30	300	22	≥40								
6012940	S40U PWLNL 08C	40	37,5	350	27	≥50								
6012941	S50V PWLNL 08C	50	47	400	35	≥63								
6012942	A16M PWLNL 6	16	14,8	150	11	≥20	WNM. 0604	6211507	6211301	-	6211515	-	-	6211586
6012943	A20P PWLNL 6	20	18,3	170	13	≥25		6211500	6211302	6211024	6211510			
6012944	A25R PWLNL 6	25	23	200	17	≥32			6211304					
6012945	A32S PWLNL 6	32	30	250	22	≥40								
6012946	A40T PWLNL 6	40	37,5	300	27	≥50	WNM. 0804	6211501	6211305	6211023	6211511	6211125	6211385	6211587
6012947	A25R PWLNL 08C	25	23	200	17	≥32								
6012948	A32S PWLNL 08C	32	30	250	22	≥40								
6012949	A40T PWLNL 08C	40	37,5	300	27	≥50								
6012950	A50U PWLNL 08C	50	47	350	35	≥63								

SCLCR/L
Anstellwinkel 95°

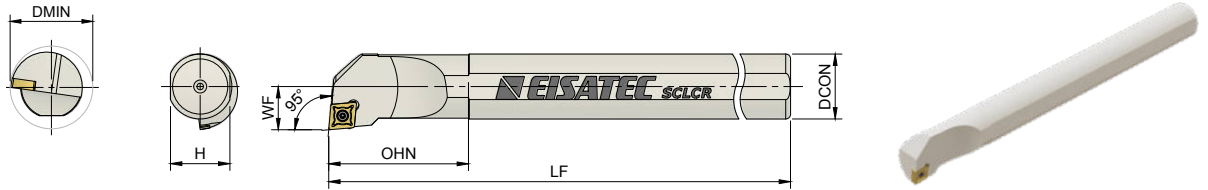

Artikelnummer Product Code	Bezeichnung Product Name	Abmessungen (mm) Dimensions (mm)							Wendeschneidplatte Insert	Klemmschraube Screw	Unterlegplatte Shim	Schraube für Unterlegplatte Shim Screw	Torx-Schlüssel Torx Key					
		DCON	BD	H	LU-OHN	LF	WF	DMIN										
6012440	S0508H SCLCR 03	8	5	7,3	18	100	3	≥6	CC.T 030102	6211320			6211600					
6012441	S0608H SCLCR 06	8	6	7,3	25	100	4,5	≥8	CC.T 0602	6211335			6211602					
6012442	S08H SCLCR 06	8	8	7,3	20	100	06	≥11		6211337				6211604				
6012443	S10K SCLCR 06	10	10	9	25	125	07	≥13							-	-		
6012444	S12K SCLCR 06	12	12	11	25	125	09	≥16										
6012445	S1216P SCLCR 06	16	11,5	14,8	37	170	09	≥16										
6012446	S16P SCLCR 06	16	16	14,8	35	170	11	≥20										
6012447	S12K SCLCR 09	12	12	11	30	125	09	≥16	CC.T 09T3		6211364						6211604	
6012448	S1416P SCLCR 09	16	14	14,8	45	170	9,5	≥17		6211365								
6012449	S16P SCLCR 09	16	16	14,8	35	170	11	≥20										
6012450	S1620R SCLCR 09	20	16	18,3	50	200	11	≥20										
6012451	S20R SCLCR 09	20	20	18,3	40	200	13	≥25										
6012452	S25S SCLCR 09	25	25	23	50	250	17	≥32		6211368	6211015	6211273						
6012453	S32T SCLCR 09	32	32	30	60	300	22	≥40										
6012454	S25S SCLCR 12	25	25	23	50	250	17	≥32	CC.T 1204	6211397	6211017	6211272	6211605					
6012455	S32T SCLCR 12	32	32	30	60	300	22	≥40										
6012456	S40U SCLCR 12	40	40	37,5	70	350	27	≥50		6211395								
6012457	A08H SCLCR 06	8	8	7,3	20	100	06	≥11	CC.T 0602	6211337	-	-	6211602					
6012458	A10H SCLCR 06	10	10	9	25	100	07	≥13										
6012459	A12H SCLCR 06	12	12	11	25	100	09	≥16										
6012460	A16M SCLCR 09	16	16	14,8	35	150	11	≥20	CC.T 09T3	6211365	-	-	6211604					
6012461	A20P SCLCR 09	20	20	18,3	40	170	13	≥25										
6012462	A25R SCLCR 09	25	25	23	50	200	17	≥32										
6012463	A32S SCLCR 09	32	32	30	60	250	22	≥40										
6012464	A25R SCLCR 12	25	25	23	50	200	17	≥32	CC.T 1204	6211397	6211017	6211272	6211605					

SCLCR/L
Anstellwinkel 95°

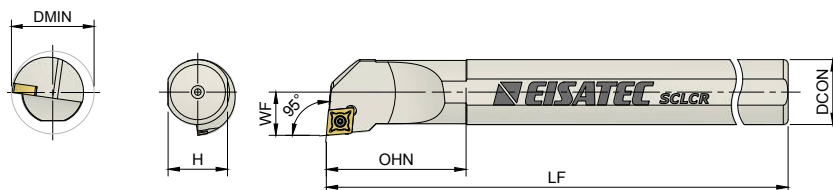

Artikelnummer Product Code	Bezeichnung Product Name	Abmessungen (mm) Dimensions (mm)							Wendeschneidplatte Insert	Klemmschraube Screw	Unterlegplatte Shim	Schraube für Unterlegplatte Shim Screw	Torx-Schlüssel Torx Key		
		DCON	BD	H	LU=OHN	LF	WF	DMIN							
6012477		8	5	7,3	18	100	3	≥6	CC.T 030102	6211320				6211600	
6012478		8	6	7,3	25	100	4,5	≥8	CC.T 0602	6211335				6211602	
6012479		8	8	7,3	20	100	06	≥11							
6012480		10	10	9	25	125	07	≥13							
6012481		12	12	11	25	125	09	≥16							
6012482		16	11,5	14,8	37	170	09	≥16							
6012483		16	16	14,8	35	170	11	≥20							
6012484		12	12	11	30	125	09	≥16		6211364					
6012485		16	14	14,8	45	170	9,5	≥17							
6012486		16	16	14,8	35	170	11	≥20		6211365				6211604	
6012487		20	16	18,3	50	200	11	≥20	CC.T 09T3						
6012488		20	20	18,3	40	200	13	≥25							
6012489		25	25	23	50	250	17	≥32		6211368	6211015	6211273			
6012490		32	32	30	60	300	22	≥40		6211368	6211015	6211273			
6012491		25	25	23	50	250	17	≥32							
6012492		32	32	30	60	300	22	≥40	CC.T 1204	6211397	6211017	6211272		6211605	
6012493		40	40	37,5	70	350	27	≥50		6211395					
6012494		8	8	7,3	20	100	06	≥11							
6012495		10	10	9	25	100	07	≥13	CC.T 0602	6211337				6211602	
6012496		12	12	11	25	100	09	≥16							
6012497		16	16	14,8	35	150	11	≥20							
6012498		20	20	18,3	40	170	13	≥25		6211365				6211604	
6012499		25	25	23	50	200	17	≥32	CC.T 09T3						
6012500		32	32	30	60	250	22	≥40		6211368	6211015	6211273			
6012501		25	25	23	50	200	17	≥32	CC.T 1204	6211397	6211017	6211272		6211605	

SCFCR/L
Anstellwinkel 90°

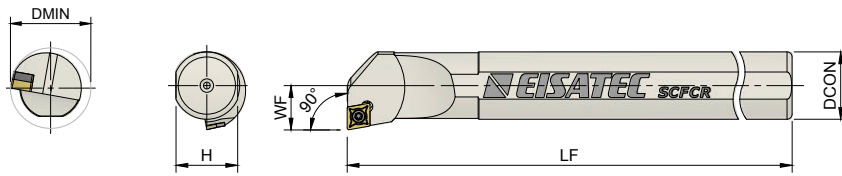

Artikelnummer Product Code	Bezeichnung Product Name	DCON	Abmessungen (mm) Dimensions (mm)				Wendeschneidplatte Insert	Klemmschraube Screw	Unterlegplatte Shim	Schraube für Unterlegplatte Shim Screw	Torx-Schlüssel Torx Key
			H	LF	WF	DMIN					
6012510	S08H SCFCR 06	8	7.3	100	6	≥11	CC.T 0602	6211337			6211602
6012511	S10K SCFCR 06	10	9	125	7	≥13					
6012512	S12K SCFCR 06	12	11	125	9	≥16	CC.T 09T3	6211364	-	-	6211604
6012513	S12K SCFCR 09	12	11	125	9	≥16					
6012514	S16P SCFCR 09	16	14.8	170	11	≥20					
6012515	S20R SCFCR 09	20	18.3	200	13	≥25					
6012516	S25S SCFCR 09	25	23	250	17	≥32	CC.T 0602	6211368	6211015	6211273	6211605
6012517	S25S SCFCR 12	25	23	250	17	≥32					
6012518	A08H SCFCR 06	8	7.3	100	6	≥11	6211397	6211017	6211272	6211605	
							6211337	-	-	6211602	
6012519	S08H SCFCL 06	8	7.3	100	6	≥11	CC.T 0602	6211337			6211602
6012520	S10K SCFCL 06	10	9	125	7	≥13					
6012521	S12K SCFCL 06	12	11	125	9	≥16	CC.T 09T3	6211364	-	-	6211604
6012522	S12K SCFCL 09	12	11	125	9	≥16					
6012523	S16P SCFCL 09	16	14.8	170	11	≥20					
6012524	S20R SCFCL 09	20	18.3	200	13	≥25					
6012525	S25S SCFCL 09	25	23	250	17	≥32	CC.T 0602	6211368	6211015	6211273	6211605
6012526	S25S SCFCL 12	25	23	250	17	≥32					
6012527	A08H SCFCL 06	8	7.3	100	6	≥11	6211397	6211017	6211272	6211605	
							6211337	-	-	6211602	

SDQCR/L

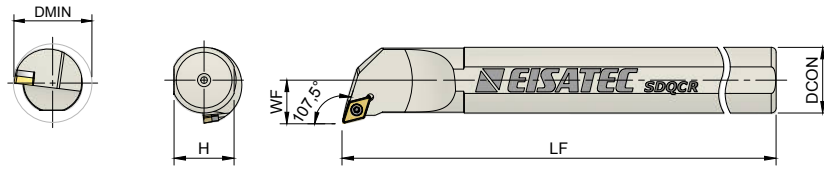

Artikelnummer Product Code	Bezeichnung Product Name	Abmessungen (mm) Dimensions (mm)				Wendeschneidplatte Insert	Klemmschraube Screw	Unterlegplatte Shim	Schraube für Unterlegplatte Shim Screw	Torx-Schlüssel Torx Key
		DCON	H	WF	DMIN					
6012353	S10K SDQCR 7	10	9	7	≥13	DC.T 0702	6211337	-	-	6211602
6012354	S12K SDQCR 7	12	11	9	≥16					
6012355	S16P SDQCR 7	16	14.8	11	≥20					
6012356	S20R SDQCR 7	20	18.3	13	≥25					
6012357	S16P SDQCR 11	16	14.8	11	≥20	DC.T 11T3	6211365 6211367 6211368 6211369	6211035	6211273 6211271	6211604
6012358	S20R SDQCR 11	20	18.3	13	≥25					
6012359	S25S SDQCR 11	25	23	17	≥32					
6012360	S32T SDQCR 11	32	30	22	≥40					
6012361	S40U SDQCR 11	40	37.5	27	≥50	DC.T 0702	6211337	-	-	6211602
6012362	A10H SDQCR 7	10	9	7	≥13					
6012363	A12H SDQCR 7	12	11	9	≥16					
6012364	A16M SDQCR 7	16	14.8	11	≥20					
6012365	A20P SDQCR 7	20	18.3	13	≥25	DC.T 11T3	6211365 6211367 6211368 6211369	6211035	6211273 6211271	6211604
6012366	A16M SDQCR 11	16	14.8	11	≥20					
6012367	A20P SDQCR 11	20	18.3	13	≥25					
6012368	A25R SDQCR 11	25	23	17	≥32					
6012369	A32S SDQCR 11	32	30	22	≥40					
6012370	S10K SDQCL 7	10	9	7	≥13	DC.T 0702	6211337	-	-	6211602
6012371	S12K SDQCL 7	12	11	9	≥16					
6012372	S16P SDQCL 7	16	14.8	11	≥20					
6012373	S20R SDQCL 7	20	18.3	13	≥25					
6012374	S16P SDQCL 11	16	14.8	11	≥20	DC.T 11T3	6211365 6211367 6211368 6211369	6211035	6211273 6211271	6211604
6012375	S20R SDQCL 11	20	18.3	13	≥25					
6012376	S25S SDQCL 11	25	23	17	≥32					
6012377	S32T SDQCL 11	32	30	22	≥40					
6012378	S40U SDQCL 11	40	37.5	27	≥50	DC.T 0702	6211337	-	-	6211602
6012379	A10H SDQCL 7	10	9	7	≥13					
6012380	A12H SDQCL 7	12	11	9	≥16					
6012381	A16M SDQCL 7	16	14.8	11	≥20					
6012382	A20P SDQCL 7	20	18.3	13	≥25	DC.T 11T3	6211365 6211367 6211368 6211369	6211035	6211273 6211271	6211604
6012383	A16M SDQCL 11	16	14.8	11	≥20					
6012384	A20P SDQCL 11	20	18.3	13	≥25					
6012385	A25R SDQCL 11	25	23	17	≥32					
6012386	A32S SDQCL 11	32	30	22	≥40					

SDUCR/L
Anstellwinkel 93°

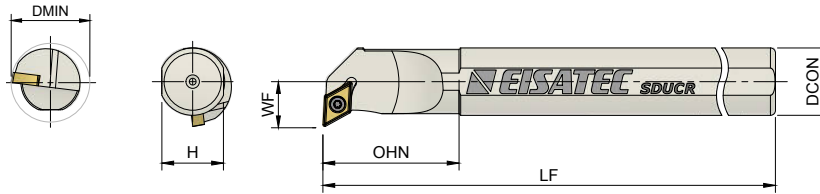

Artikelnummer Product Code	Bezeichnung Product Name	Abmessungen (mm) Dimensions (mm)							Wendeschneidplatte Insert	Klemmschraube Screw	Unterlegplatte Shim	Schraube für Unterlegplatte Shim Screw	Torx-Schlüssel Torx Key
		DCON	BD	H	LU=OHN	LF	WF	DMIN					
6012292	S0810K SDUCR 07	10	8	9	30	125	8	≥13	DC.T 0702	6211337			6211602
6012293	S10K SDUCR 07	10	10	9	25	125	8	≥13					
6012294	S12K SDUCR 07	12	12	11	25	125	9	≥16					
6012295	S1216P SDUCR 07	16	11.5	14.8	37	170	9	≥16					
6012296	S1416P SDUCR 07	16	14	14.8	45	170	9.5	≥17					
6012297	S16P SDUCR 07	16	16	14.8	35	170	11	≥20					
6012298	S20R SDUCR 07	20	20	18.3	40	200	13	≥25					
6012299	S1416P SDUCR 11	16	14	14.8	45	170	11	≥18					
6012300	S16P SDUCR 11	16	16	14.8	35	170	11	≥20					
6012301	S1620R SDUCR 11	20	16	18.3	50	200	11	≥20					
6012302	S20R SDUCR 11	20	20	18.3	40	200	13	≥25	DC.T 11T3	6211368	6211035	6211273	6211604
6012303	S25S SDUCR 11	25	25	23	50	250	17	≥32					
6012304	S25T SDUCR 11	25	25	23	50	300	17	≥32					
6012305	S32T SDUCR 11	32	32	30	60	300	22	≥40					
6012306	S40U SDUCR 11	40	40	37.5	70	350	27	≥50					
6012307	S50V SDUCR 11	50	50	47	80	400	35	≥63					
6012308	A0810H SDUCR 07	10	8	9	30	100	8	≥13					
6012309	A10H SDUCR 07	10	10	9	25	100	8	≥13					
6012310	A12H SDUCR 07	12	12	11	25	100	9	≥16					
6012311	A16M SDUCR 07	16	16	14.8	35	150	11	≥20					
6012312	A20P SDUCR 07	20	20	18.3	40	170	13	≥25					
6012313	A16M SDUCR 11	16	16	14.8	35	150	11	≥20					
6012314	A20P SDUCR 11	20	20	18.3	40	170	13	≥25					
6012315	A25R SDUCR 11	25	25	23	50	200	17	≥32					
6012316	A25T SDUCR 11	25	25	23	50	300	17	≥32					
6012317	A32S SDUCR 11	32	32	30	60	250	22	≥40					
6012318	A50U SDUCR 11	50	50	47	80	350	35	≥63	DC.T 11T3	6211369	6211035	6211271	6211604

SDUCR/L
Anstellwinkel 93°

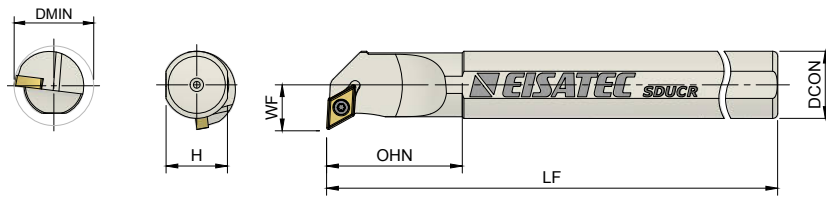

Artikelnummer Product Code	Bezeichnung Product Name	Abmessungen (mm) Dimensions (mm)							Wendeschneidplatte Insert	Klemmschraube Screw	Unterlegplatte Shim	Schraube für Unterlegplatte Shim Screw	Torx-Schlüssel Torx Key
		DCON	BD	H	LU=OHN	LF	WF	DMIN					
6012324	S0810K SDUCL 07	10	8	9	30	125	8	≥13	DC.T 0702	6211337	-	-	6211602
6012325	S10K SDUCL 07	10	10	9	25	125	8	≥13					
6012326	S12K SDUCL 07	12	12	11	25	125	9	≥16					
6012327	S1216P SDUCL 07	16	11.5	14.8	37	170	9	≥16					
6012328	S1416P SDUCL 07	16	14	14.8	45	170	9.5	≥17					
6012329	S16P SDUCL 07	16	16	14.8	35	170	11	≥20					
6012330	S20R SDUCL 07	20	20	18.3	40	200	13	≥25	DC.T 11T3	6211365	-	-	6211604
6012331	S1416P SDUCL 11	16	14	14.8	45	170	11	≥18					
6012332	S16P SDUCL 11	16	16	14.8	35	170	11	≥20					
6012333	S1620R SDUCL 11	20	16	18.3	50	200	11	≥20	DC.T 11T3	6211367	-	-	6211604
6012334	S20R SDUCL 11	20	20	18.3	40	200	13	≥25					
6012335	S25S SDUCL 11	25	25	23	50	250	17	≥32					
6012336	S32T SDUCL 11	32	32	30	60	300	22	≥40					
6012337	S40U SDUCL 11	40	40	37.5	70	350	27	≥50					
6012338	S50V SDUCL 11	50	50	47	80	400	35	≥63					
6012339	A0810H SDUCL 07	10	8	9	30	100	8	≥13	DC.T 0702	6211337	-	-	6211602
6012340	A10H SDUCL 07	10	10	9	25	100	8	≥13					
6012341	A12H SDUCL 07	12	12	11	25	100	9	≥16					
6012342	A16M SDUCL 07	16	16	14.8	35	150	11	≥20					
6012343	A20P SDUCL 07	20	20	18.3	40	170	13	≥25					
6012344	A16M SDUCL 11	16	16	14.8	35	150	11	≥20					
6012345	A20P SDUCL 11	20	20	18.3	40	170	13	≥25	DC.T 11T3	6211367	6211035	6211273	6211604
6012346	A25R SDUCL 11	25	25	23	50	200	17	≥32					
6012347	A32S SDUCL 11	32	32	30	60	250	22	≥40					

STFCR/L
Anstellwinkel 90°

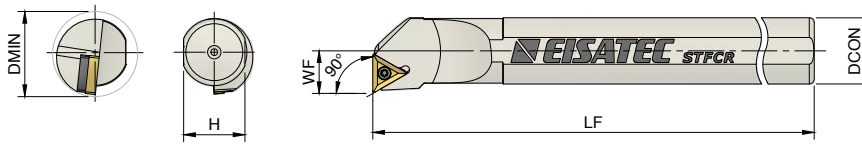

Artikelnummer Product Code	Bezeichnung Product Name	Abmessungen (mm) Dimensions (mm)					Wendeschneidplatte Insert	Klemmschraube Screw	Unterlegplatte Shim	Schraube für Unterlegplatte Shim Screw	Torx-Schlüssel Torx Key
		DCON	H	LF	WF	DMIN					
6012694	S0610F STFCR 06	10	9	80	4.5	≥08	TC.T 06T1	6211325			6211600
6012695	S08H STFCR 06	8	7.3	100	6	≥11					
6012696	S10K STFCR 09	10	9	125	7	≥13	TC.T 0902	6211327			6211601
6012697	S12K STFCR 09	12	11	125	9	≥17					
6012698	S12K STFCR 11	12	11	125	9	≥17	TC.T 1102	6211337	-	-	6211602
6012699	S16P STFCR 11	16	14.8	170	11	≥20					
6012700	S20R STFCR 11	20	18.3	200	13	≥25	TC.T 16T3	6211365 6211367			6211604
6012701	S16P STFCR 16	16	14.8	170	11	≥20					
6012702	S20R STFCR 16	20	18.3	200	13	≥25	TC.T 16T3	6211369		6211273	6211604
6012703	S25S STFCR 16	25	23	250	17	≥32					
6012704	S32T STFCR 16	32	30	300	22	≥40	TC.T 1102	6211337	-	6211271	6211602
6012705	S40U STFCR 16	40	37.5	350	27	≥50					
6012706	A10H STFCR 11	10	9	100	7	≥13	TC.T 1102	6211337			6211602
6012707	A12H STFCR 11	12	11	100	9	≥17					
6012708	A16M STFCR 11	16	14.8	150	11	≥20					
6012717	S0610F STFCR 06	10	9	80	4.5	≥08	TC.T 06T1	6211325			6211600
6012719	S08H STFCR 06	8	7.3	100	6	≥11					
6012716	S10K STFCR 09	10	9	125	7	≥13	TC.T 0902	6211327			6211601
6012715	S12K STFCR 09	12	11	125	9	≥17					
6012718	S12K STFCR 11	12	11	125	9	≥17	TC.T 1102	6211337	-	-	6211602
6012709	S16P STFCR 11	16	14.8	170	11	≥20					
6012710	S20R STFCR 11	20	18.3	200	13	≥25	TC.T 16T3	6211365 6211367			6211604
6012711	S16P STFCR 16	16	14.8	170	11	≥20					
6012712	S20R STFCR 16	20	18.3	200	13	≥25	TC.T 16T3	6211369		6211273	6211604
6012713	S25S STFCR 16	25	23	250	17	≥32					
6012714	S32T STFCR 16	32	30	300	22	≥40	TC.T 1102	6211337	-	6211271	6211602
6012720	S40U STFCR 16	40	37.5	350	27	≥50					
6012721	A10H STFCR 11	10	9	100	7	≥13	TC.T 1102	6211337			6211602
6012722	A12H STFCR 11	12	11	100	9	≥17					
6012723	A16M STFCR 11	16	14.8	150	11	≥20					

SCLCR/L
Anstellwinkel 95°

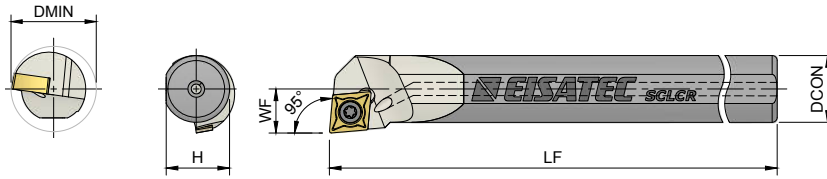

Hartmetall/Carbide

Artikelnummer Product Code	Bezeichnung Product Name	Abmessungen (mm) Dimensions (mm)					Wendeschneidplatte Insert	Klemmschraube Screw	Torx-Schlüssel Torx Key
		DCON	H	LF	WF	DMIN			
6012465	C04G SCLCR 03	4	3.7	90	2.5	≥5	CC. 0301	6211320	6211600
6012466	C05H SCLCR 03	5	4.7	100	3	≥6			
6012467	C06J SCLCR 04	6	5.7	110	3.5	≥7			
6012468	C07K SCLCR 04	7	6.7	125	4	≥8	CC. 0401	6211323	
6012469	C06J SCLCR 06	6	5.7	110	4.5	≥8			
6012470	E08K SCLCR 06	8	7.5	125	6	≥11	CC.T 0602	6211335	6211602
6012471	E10M SCLCR 06	10	9.5	150	7	≥13		6211337	
6012472	E12Q SCLCR 06	12	11	180	9	≥16			
6012473	E16R SCLCR 09	16	15	200	11	≥20	CC.T 09T3	6211365	6211604
6012474	E20S SCLCR 09	20	19	250	13	≥24			
6012504	C06J SCLCL 06	6	5.7	110	4.5	≥8	CC.T 0602	6211335	6211602
6012505	E08K SCLCL 06	8	7.5	125	6	≥11		6211337	
6012506	E10M SCLCL 06	10	9.5	150	7	≥13			
6012507	E12Q SCLCL 06	12	11	180	9	≥16			
6012508	E16R SCLCL 09	16	15	200	11	≥20	CC.T 09T3	6211365	6211604
6012509	E20S SCLCL 09	20	19	250	13	≥24			

STFCR/L
Anstellwinkel 90°

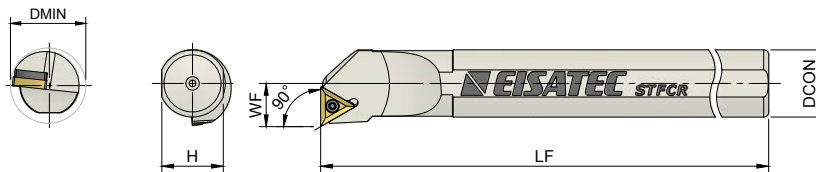

Hartmetall/Carbide

Artikelnummer Product Code	Bezeichnung Product Name	Abmessungen (mm) Dimensions (mm)					Wendeschneidplatte Insert	Klemmschraube Screw	Torx-Schlüssel Torx Key
		DCON	H	LF	WF	DMIN			
6018250	E10M STFCR 09	10	9.5	150	6	12	TC.T 0902	6211327	6211601
6018251	E12Q STFCR 09	12	11	180	8	15			
6018252	E12Q STFCR 11	12	11	180	8	15			
6018259	E10M STFCL 09	10	9.5	150	6	12	TC.T 0902	6211327	6211601
6018260	E12Q STFCL 09	12	11	180	8	15			
6018261	E12Q STFCL 11	12	11	180	8	15			

STUPR/L
Anstellwinkel 93°

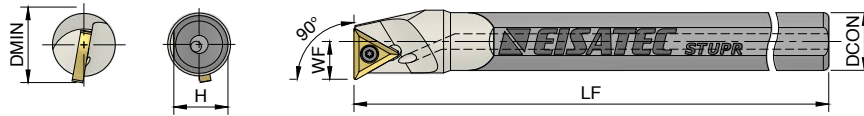

Hartmetall/Carbide

Artikelnummer Product Code	Bezeichnung Product Name	Abmessungen (mm) Dimensions (mm)					Wendeschneidplatte Insert	Klemmschraube Screw	Torx-Schlüssel Torx Key
		DCON	H	LF	WF	DMIN			
6018253	E12Q STUPR 1103	12	11	180	8	15	TP. 1103	6211348	6211603
6018254	E16R STUPR 1103	16	15	200	11	20		6211349	
6012794	E12Q STUPL 1103	12	11	180	8	15	TP. 1103	6211348	6211603
6012795	E16R STUPL 1103	16	15	200	11	20		6211349	



DREHWERKZEUGE ZUM GEWINDEDREHEN
THREAD TURNING TOOLS

AUSSEN
EXTERNAL



INNEN
INTERNAL



SER/L

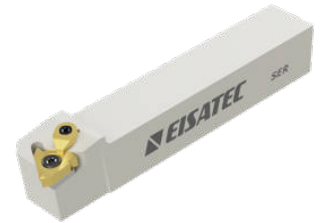
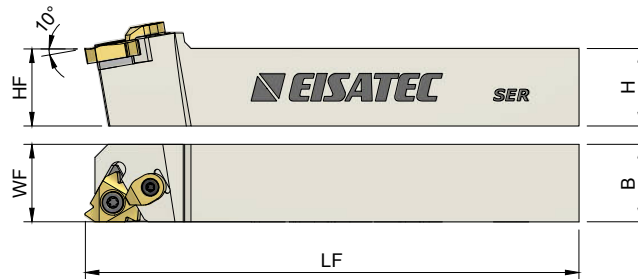

Artikelnummer Product Code	Bezeichnung Product Name	Abmessungen (mm) Dimensions (mm)				Wendeschneidplatte Insert	Klemmschraube Screw	Unterlegplatte Shim	Schraube für Unterlegplatte Shim Screw	Spannpratze Wedge Clamp	Klemmschraube Clamp Screw	Torx-Schlüssel Torx Key	
		HF=H	B	LF	WF								
6013076	SER 0808 E11	8	8	70	11								
6013077	SER 1010 E11	10	10	70	11								
6013078	SER 1212 F11	12	12	80	12	11 ER/EL	6211337	-	-	-	-	6211602	
6013079	SER 1616 H11	16	16	100	16								
6013080	SER 2020 H11	20	20	100	20								
6013081	SER 1616 H16C	16	16	100	16								
6013082	SER 2020 K16C	20	20	125	20	16 ER/EL (0.35 - 3) ISO METRIC	6211369	6211006	6211271			6211604	
6013083	SER 2525 M16C	25	25	150	25								
6013084	SER 3232 P16C	32	32	170	32								
6013085	SER 2525 M22C	25	25	150	25	22 ER/EL (3.5 - 4.5) ISO METRIC	6211395	6211007	6211274	6211125	6211385	6211605	
6013086	SER 3232 P22C	32	32	170	32								
6013087	SER 4040 S22C	40	40	250	40								
6013088	SER 2525 M16C-T	25	25	150	25	16 ER/L (1.5-3 TR)	6211369	-	-				
6013089	SER 2525 M22C-T	25	25	150	25	22 ER/L (4-6 TR)	6211395	-	-			6211605	
6013090	SER 2020 K16C-S	20	20	125	25								
6013091	SER 2525 M16C-S	25	25	150	31	SN 166 ER/L16	6211369	6211006	6211271			6211604	
6013092	SER 3232 P16C-S	32	32	170	38.5								
6013104	SEL 0808 E11	8	8	70	11								
6013105	SEL 1010 E11	10	10	70	11								
6013106	SEL 1212 F11	12	12	80	12	11 ER/EL	6211337	-	-	-	-	6211602	
6013107	SEL 1616 H11	16	16	100	16								
6013108	SEL 2020 H11	20	20	100	20								
6013109	SEL 1616 H16C	16	16	100	16								
6013110	SEL 2020 K16C	20	20	125	20	16 ER/EL (0.35 - 3) ISO METRIC	6211369	6211006	6211271			6211604	
6013111	SEL 2525 M16C	25	25	150	25								
6013112	SEL 3232 P16C	32	32	170	32								
6013113	SEL 2525 M22C	25	25	150	25	22 ER/EL (3.5 - 4.5) ISO METRIC	6211395	6211007	6211274	6211125	6211385	6211605	
6013114	SEL 3232 P22C	32	32	170	32								
6013115	SEL 4040 S22C	40	40	250	40								
6013116	SEL 2525 M16C-T	25	25	150	25	16 ER/L (1.5-3 TR)	6211369	-	-				
6013117	SEL 2525 M22C-T	25	25	150	25	22 ER/L (4-6 TR)	6211395	-	-			6211605	
6013118	SEL 2020 K16C-S	20	20	125	25								
6013119	SEL 2525 M16C-S	25	25	150	31	SN 166 ER/L16	6211369	6211006	6211271			6211604	
6013120	SEL 3232 P16C-S	32	32	170	38.5								

SER/L

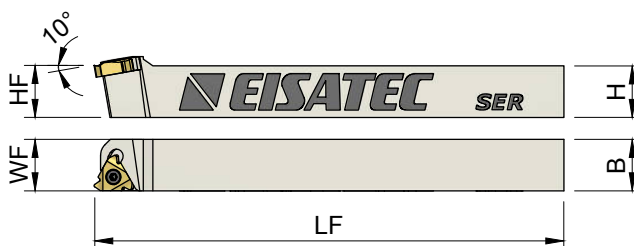

Artikelnummer Product Code	Bezeichnung Product Name	Abmessungen (mm) Dimensions (mm)				Wendeschneidplatte Insert	Klemmschraube Screw	Unterlegplatte Shim	Schraube für Unterlegplatte Shim Screw	Torx-Schlüssel Torx Key
		HF=H	B	LF	WF					
6013121	SER 1010 K11-S	10	10	125	10	11 ER/EL	6211337	-	-	6211602
6013122	SER 1212 K11-S	12	12	125	12					
6013123	SER 1212 K16-S	12	12	125	12					
6013125	SEL 1010 K11-S	10	10	125	10	11 ER/EL	6211337	-	-	6211602
6013126	SEL 1212 K11-S	12	12	125	12					
6013127	SEL 1212 K16-S	12	12	125	12					

SIR

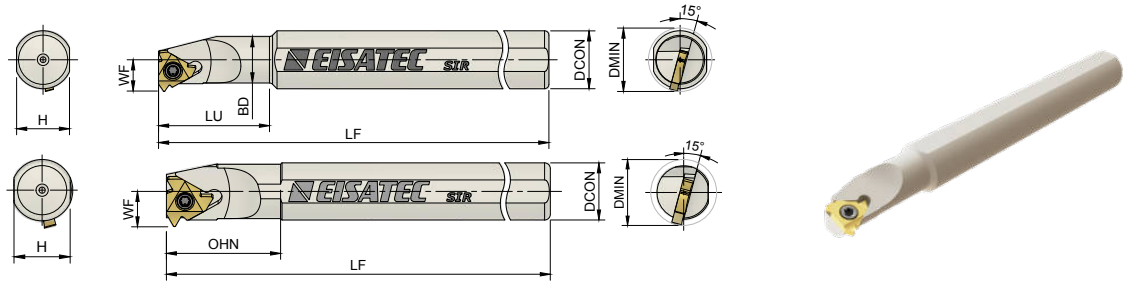

Artikelnummer Product Code	Bezeichnung Product Name	Abmessungen (mm) Dimensions (mm)							Wendeschneidplatte Insert	Klemmschraube Screw	Unterlegplatte Shim	Schraube für Unterlegplatte Shim Screw	Spannpratze Wedge Clamp	Klemmschraube Clamp Screw	Torx-Schlüssel Torx Key
		DCON	BD	LF	LU=OHN	WF	DMIN								
6013137	SIR S12x05H 06	12	5	100	15	4.3	6.4	06 IR/L	6211324						6211600
6013138	SIR S16x05H 06	16	5	100	15	4.3	6.4	08 IR/L	6211327						6211601
6013139	SIR S16x07M 08	16	7	150	18	5.3	7.8								
6013140	SIR S10H 11	10	10	100	-	7.4	12								
6013141	SIR S12K 11	12	12	125	-	8.4	15								
6013142	SIR S16X10M 11	16	10	150	25	7.4	12	11 IR/L	6211337	-	-	-	-	-	6211602
6013143	SIR S16X13M 11	16	13	150	32	8.9	15								
6013144	SIR S16M 11	16	16	150	-	11.7	19								
6013145	SIR A16X13M 16	16	12.8	150	32	9.05	16								
6013146	SIR S16X13M 16	16	13	150	32	10.2	16	16 IR/L (0.35 - 3)	6211365						6211604
6013147	SIR S16M 16	16	16	150	-	11.7	19		6211367						
6013148	SIR S20X16P 16	20	16	170	40	11.7	19		6211367						6211604
6013149	SIR A20X16P 16	20	16	170	40	11.7	19								
6013150	SIR S20P 16	20	20	170	-	13.7	24								
6013151	SIR S25R 16C	25	25	200	-	16.2	29	16 IR/L (0.35 - 3)							
6013152	SIR S32S 16C	32	32	250	-	19.7	36		6211369	6211006	6211273				
6013153	SIR S40T 16C	40	40	300	-	23.7	44				6211271	6211125	6211385		
6013154	SIR S50U 16C	50	50	350	-	28.7	54								6211604
6013155	SIR S20P 22	20	20	170	-	15.7	24		6211397	-	-	-	-	-	
6013156	SIR S25R 22C	25	25	200	-	18.1	29				6211272	6211125	6211385		
6013157	SIR S32S 22C	32	32	250	-	21.6	38	22 IR/L (3.5 - 4.5)			6211274	6211125	6211385		
6013158	SIR S40T 22C	40	40	300	-	25.6	46		6211395	6211007	6211274	6211125	6211385		
6013159	SIR S50U 22C	50	50	350	-	30.6	58				6211274	6211125	6211385		6211605
6013160	SIR S25R 16C-T	25	25	200	-	16.2	29	16 IR/L (1.5-3 TR)	6211369						6211604
6013161	SIR S32S 16C-T	32	32	250	-	19.7	36								
6013162	SIR S25R 22C-T	25	25	200	-	18.1	29	22 IR/L (4-6 TR)	6211395	-	-	-	-	-	
6013163	SIR S32S 22C-T	32	32	250	-	21.6	38	-	-						6211605

SIL

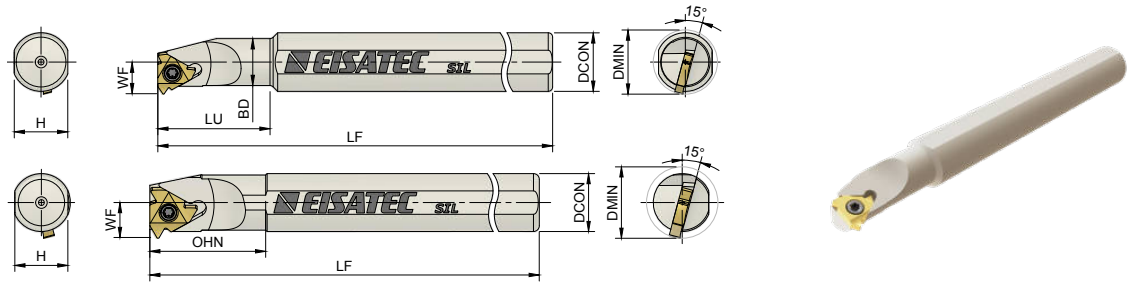

Artikelnummer Product Code	Bezeichnung Product Name	Abmessungen (mm) Dimensions (mm)						Wendeschneidplatte Insert	Klemmschraube Screw	Unterlegplatte Shim	Schraube für Unterlegplatte Shim Screw	Spannpratze Wedge Clamp	Klemmschraube Clamp Screw	Torx-Schlüssel Torx Key
		DCON	BD	LF	LU-OHN	WF	DMIN							
6013164	SIL S12x05H 06	12	5	100	15	4.3	6.4	06 IR/L	6211324					6211600
6013165	SIL S16x05H 06	16	5	100	15	4.3	6.4							
6013166	SIL S16x07M 08	16	7	150	18	5.3	7.8	08 IR/L	6211327					6211601
6013167	SIL S10H 11	10	10	100	-	7.4	12	11 IR/L	6211337	-	-	-	-	6211602
6013168	SIL S12K 11	12	12	125	-	8.4	15							
6013169	SIL S16X10M 11	16	10	150	25	7.4	12							
6013170	SIL S16X13M 11	16	13	150	32	8.9	15							
6013171	SIL S16M 11	16	16	150	-	11.7	19	16 IR/L (0.35 - 3)	6211367					6211604
6013173	SIL S16M 16	16	16	150	-	11.7	19							
6013174	SIL S20X16P 16	20	16	170	40	11.7	19	16 IR/L (0.35 - 3)	6211369	6211006	6211273	6211125	6211385	6211604
6013175	SIL S20P 16	20	20	170	-	13.7	24							
6013176	SIL S25R 16C	25	25	200	-	16.2	29							
6013177	SIL S32S 16C	32	32	250	-	19.7	36							
6013178	SIL S40T 16C	40	40	300	-	23.7	44	22 IR/L (3.5 - 4.5)	6211395	6211007	6211272	6211125	6211385	6211605
6013179	SIL S50U 16C	50	50	350	-	28.7	54							
6013180	SIL S20P 22	20	20	170	-	15.7	24	16 IR/L (1.5-3 TR)	6211397	-	-	-	-	6211604
6013181	SIL S25R 22C	25	25	200	-	18.1	29							
6013182	SIL S32S 22C	32	32	250	-	21.6	38	22 IR/L (4-6 TR)	6211395	-	-	-	-	6211605
6013183	SIL S40T 22C	40	40	300	-	25.6	46							
6013184	SIL S50U 22C	50	50	350	-	30.6	58							
6013185	SIL S25R 16C-T	25	25	200	-	16.2	29							
6013186	SIL S32S 16C-T	32	32	250	-	19.7	36	-	-	-	-	-	6211604	
6013187	SIL S25R 22C-T	25	25	200	-	18.1	29							
6013188	SIL S32S 22C-T	32	32	250	-	21.6	38	-	-	-	-	-	-	6211605







ABSTECH - UND EINSTECHWERKZEUGE
EXTERNAL GROOVING TOOLS

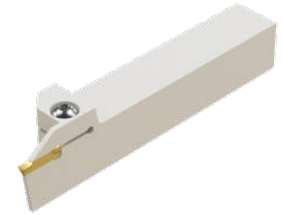
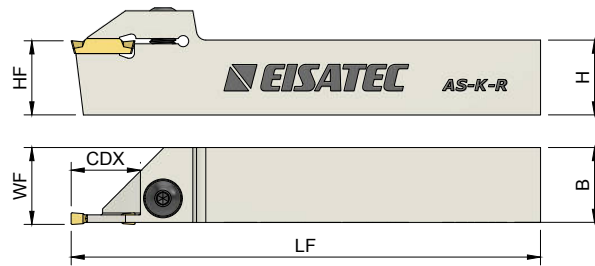
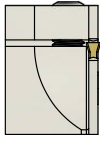

AS-K-R



Artikelnummer Product Code	Bezeichnung Product Name	Abmessungen (mm) Dimensions (mm)					Wendeschneidplatte Insert	Klemmschraube Screw	Scheibe Washer	Innensechskantschlüssel Allen Key
		HF=H	B	LF	WF	CDX				
6013218	AS-K-R-1212-1.5-T15	12	12	100	12,2	15	MGM. - 1.5			
6013219	AS-K-R-2020-1.5-T15	20	20	125	20,2	15	MGM. - 2	6211213	6211540	6211587
6013220	AS-K-R-1212-2-T15	12	12	100	16.3	15				
6013221	AS-K-R-1616-2-T10	16	16	125	16.3	10				
6013222	AS-K-R-1616-2-T15	16	16	125	16.3	15				
6013223	AS-K-R-2020-2-T15	20	20	150	20.3	15				
6013224	AS-K-R-2525-2-T15	25	25	150	25.3	15				
6013225	AS-K-R-3232-2-T15	32	32	170	32.3	15				
6013226	AS-K-R-1212-3-T15	12	12	100	12.3	15				
6013227	AS-K-R-1616-3-T15	16	16	125	16.3	15	MGM. - 3			
6013228	AS-K-R-2020-3-T10	20	20	125	20.3	10				
6013229	AS-K-R-2020-3-T20	20	20	125	20.3	20				
6013230	AS-K-R-2020-3-R28	20	20	125	20.3	28				
6013231	AS-K-R-2525-3-T10	25	25	150	25.3	10				
6013232	AS-K-R-2525-3-R15	25	25	150	25.3	15				
6013233	AS-K-R-2525-3-T22	25	25	150	25.3	22				
6013234	AS-K-R-3232-3-T10	32	32	170	32.3	10				
6013235	AS-K-R-3232-3-T22	32	32	170	32.3	22	MGM. - 4	6211241	-	6211588
6013236	AS-K-R-2020-4-T10	20	20	125	20.4	10				
6013237	AS-K-R-2020-4-T20	20	20	125	20.4	20				
6013238	AS-K-R-2020-4-R25	20	20	125	20.4	25				
6013239	AS-K-R-2525-4-T10	25	25	150	25.4	10				
6013240	AS-K-R-2525-4-T18	25	25	150	25.4	18				
6013241	AS-K-R-2525-4-T22	25	25	150	25.4	22				
6013242	AS-K-R-3232-4-T10	32	32	170	32.4	10				
6013243	AS-K-R-3232-4-T22	32	32	170	32.4	22	MGM. - 5			
6013244	AS-K-R-2020-5-T20	20	20	125	20.5	20				
6013245	AS-K-R-2525-5-T15	25	25	150	25.5	15				
6013246	AS-K-R-2525-5-T18	25	25	150	25.5	18				
6013247	AS-K-R-2525-5-T25	25	25	150	25.5	25				
6013248	AS-K-R-3232-5-T15	32	32	170	32.5	15				
6013249	AS-K-R-3232-5-T25	32	32	170	32.5	25				
6013250	AS-K-R-2525-6-T15	25	25	150	25.6	15				
6013251	AS-K-R-2525-6-T25	25	25	150	25.6	25	MGM. - 6			
6013252	AS-K-R-3232-6-T25	32	32	170	32.6	25	MGM. - 8			
6013253	AS-K-R-3232-8-T32	32	32	170	32.8	32				

Kompatibel mit KR - JD Wendeplatten. / Compatible with KR - JD Insert.

AS-K-L

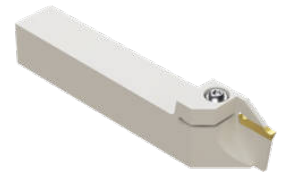
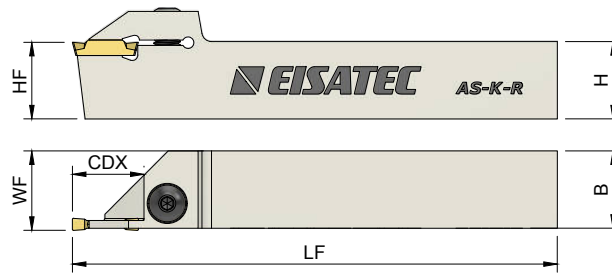
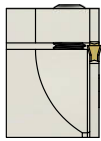

Artikelnummer Product Code	Bezeichnung Product Name	Abmessungen (mm) Dimensions (mm)					Wendeschneidplatte Insert	Klemmschraube Screw	Scheibe Washer	Innensechskantschlüssel Allen Key
		HF=H	B	LF	WF	CDX				
6013254	AS-K-L-1212-1.5-T15	12	12	100	12,2	15	MGM. - 1.5	6211213	6211540	6211587
6013255	AS-K-L-2020-1.5-T15	20	20	125	20,2	15				
6013256	AS-K-L-1212-2-T15	12	12	100	16.3	15	MGM. - 2	6211213	6211540	6211587
6013257	AS-K-L-1616-2-T10	16	16	125	16.3	10				
6013258	AS-K-L-1616-2-T15	16	16	125	16.3	15				
6013259	AS-K-L-2020-2-T15	20	20	150	20.3	15				
6013260	AS-K-L-2525-2-T15	25	25	150	25.3	15	MGM. - 3	6211241	-	6211588
6013261	AS-K-L-3232-2-T15	32	32	170	32.3	15				
6013262	AS-K-L-1212-3-T15	12	12	100	12.3	15				
6013263	AS-K-L-1616-3-T15	16	16	125	16.3	15				
6013264	AS-K-L-2020-3-T10	20	20	125	20.3	10				
6013265	AS-K-L-2020-3-T20	20	20	125	20.3	20				
6013266	AS-K-L-2020-3-R28	20	20	125	20.3	28				
6013267	AS-K-L-2525-3-T10	25	25	150	25.3	10				
6013268	AS-K-L-2525-3-R15	25	25	150	25.3	15				
6013269	AS-K-L-2525-3-T22	25	25	150	25.3	22	MGM. - 4	6211241	-	6211588
6013270	AS-K-L-3232-3-T10	32	32	170	32.3	10				
6013271	AS-K-L-3232-3-T22	32	32	170	32.3	22				
6013272	AS-K-L-2020-4-T10	20	20	125	20.4	10				
6013273	AS-K-L-2020-4-T20	20	20	125	20.4	20	MGM. - 5	6211241	-	6211588
6013274	AS-K-L-2020-4-R25	20	20	125	20.4	25				
6013275	AS-K-L-2525-4-T10	25	25	150	25.4	10				
6013276	AS-K-L-2525-4-T18	25	25	150	25.4	18				
6013277	AS-K-L-2525-4-T22	25	25	150	25.4	22				
6013278	AS-K-L-3232-4-T10	32	32	170	32.4	10				
6013279	AS-K-L-3232-4-T22	32	32	170	32.4	22				
6013280	AS-K-L-2020-5-T20	20	20	125	20.5	20				
6013281	AS-K-L-2525-5-T15	25	25	150	25.5	15	MGM. - 6	6211241	-	6211588
6013282	AS-K-L-2525-5-T18	25	25	150	25.5	18				
6013283	AS-K-L-2525-5-T25	25	25	150	25.5	25				
6013284	AS-K-L-3232-5-T15	32	32	170	32.5	15				
6013285	AS-K-L-3232-5-T25	32	32	170	32.5	25	MGM. - 8	6211241	-	6211588
6013286	AS-K-L-2525-6-T15	25	25	150	25.6	15				
6013287	AS-K-L-2525-6-T25	25	25	150	25.6	25				
6013288	AS-K-L-3232-6-T25	32	32	170	32.6	25				
6013289	AS-K-L-3232-8-T32	32	32	170	32.8	32				

Kompatibel mit KR - JD Wendepplatten. / Compatible with KR - JD Insert.

AS-ZCC2-R

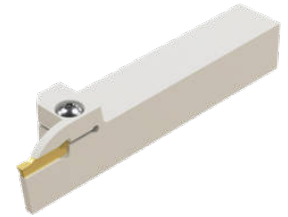
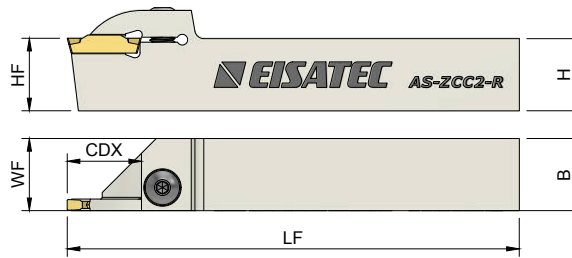
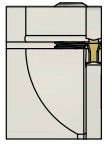

Artikelnummer Product Code	Bezeichnung Product Name	Abmessungen (mm) Dimensions (mm)					Wendeschneidplatte Insert	Klemmschraube Screw	Scheibe Washer	Innensechskant- Schlüssel Allen Key
		HF=H	B	LF	WF	CDX				
6013481	AS-ZCC2-R-1616-2-T15	16	16	125	16.2	15	Z.BD - 2	6211213	6211540	6211587
6013482	AS-ZCC2-R-2020-2-T7	20	20	125	20.2	7				
6013483	AS-ZCC2-R-2020-2-T15	20	20	125	20.2	15	Z.ED - 2.5	6211241	-	6211588
6013484	AS-ZCC2-R-2525-2-T15	25	25	150	25.2	15				
6013485	AS-ZCC2-R-1616-2.5-T15	16	16	125	16.3	15	Z.FD - 3	6211241	-	6211588
6013486	AS-ZCC2-R-2020-2.5-T17	20	20	125	20.3	17				
6013487	AS-ZCC2-R-2525-2.5-T15	25	25	150	25.3	15	Z.GD - 4	6211241	-	6211588
6013488	AS-ZCC2-R-1616-3-T15	16	16	125	16.3	15				
6013489	AS-ZCC2-R-1616-3-T17	16	16	125	16.3	17	Z.HD - 5	6211241	-	6211588
6013490	AS-ZCC2-R-1616-3-T20	16	16	125	16.3	20				
6013491	AS-ZCC2-R-2020-3-T12	20	20	125	20.3	12	Z.KD - 6	6211241	-	6211588
6013492	AS-ZCC2-R-2020-3-T20	20	20	125	20.3	20				
6013493	AS-ZCC2-R-2020-3-R21	20	20	125	20.3	21	Z.HD - 5	6211241	-	6211588
6013494	AS-ZCC2-R-2020-3-R25	20	20	125	20.3	25				
6013495	AS-ZCC2-R-2525-3-T12	25	25	150	25.3	12	Z.KD - 6	6211241	-	6211588
6013496	AS-ZCC2-R-2525-3-T22	25	25	150	25.3	22				
6013497	AS-ZCC2-R-2525-3-R30	25	25	150	25.3	30	Z.KD - 6	6211241	-	6211588
6013498	AS-ZCC2-R-2020-4-T12	20	20	125	20.5	12				
6013499	AS-ZCC2-R-2020-4-T20	20	20	125	20.5	20	Z.HD - 5	6211241	-	6211588
6013500	AS-ZCC2-R-2525-4-T12	25	25	150	25.5	12				
6013501	AS-ZCC2-R-2525-4-T22	25	25	150	25.5	22	Z.KD - 6	6211241	-	6211588
6013502	AS-ZCC2-R-2020-5-T12	20	20	125	20.5	12				
6013503	AS-ZCC2-R-2020-5-T20	20	20	125	20.5	20	Z.HD - 5	6211241	-	6211588
6013504	AS-ZCC2-R-2525-5-T12	25	25	150	25.5	12				
6013505	AS-ZCC2-R-2525-5-T25	25	25	150	25.5	25	Z.KD - 6	6211241	-	6211588
6013506	AS-ZCC2-R-3232-5-T25	32	32	170	32.5	25				
6013507	AS-ZCC2-R-2020-6-T20	20	20	125	20.6	20	Z.HD - 5	6211241	-	6211588
6013508	AS-ZCC2-R-2525-6-T25	25	25	150	25.6	25				
6013509	AS-ZCC2-R-3232-6-T25	32	32	170	32.6	25	Z.KD - 6	6211241	-	6211588
6013510	AS-ZCC2-R-3232-6-T30	32	32	170	32.6	30				

Kompatibel mit ZCC Wendepplatten. / Compatible with ZCC inserts.

AS-ZCC2-L

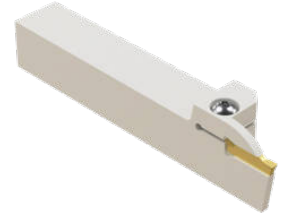
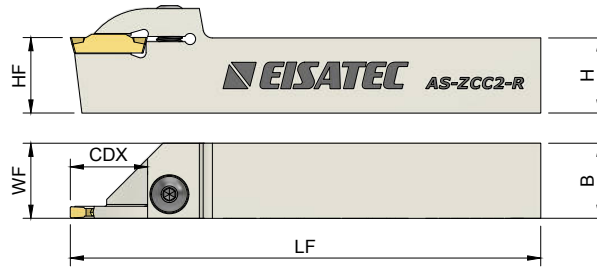
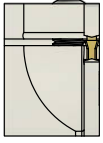

Artikelnummer Product Code	Bezeichnung Product Name	Abmessungen (mm) Dimensions (mm)					Wendeschneidplatte Insert	Klemmschraube Screw	Scheibe Washer	Innensechskantschlüssel Allen Key
		HF=H	B	LF	WF	CDX				
6013511	AS-ZCC2-L-1616-2-T15	16	16	125	16.2	15	Z.BD - 2	6211213	6211540	6211587
6013512	AS-ZCC2-L-2020-2-T7	20	20	125	20.2	7				
6013513	AS-ZCC2-L-2020-2-T15	20	20	125	20.2	15				
6013514	AS-ZCC2-L-2525-2-T15	25	25	150	25.2	15				
6013515	AS-ZCC2-L-1616-2.5-T15	16	16	125	16.3	15				
6013516	AS-ZCC2-L-2020-2.5-T17	20	20	125	20.3	17				
6013517	AS-ZCC2-L-2525-2.5-T15	25	25	150	25.3	15				
6013518	AS-ZCC2-L-1616-3-T15	16	16	125	16.3	15	Z.FD - 3	6211241	-	6211588
6013519	AS-ZCC2-L-1616-3-T17	16	16	125	16.3	17				
6013520	AS-ZCC2-L-1616-3-T20	16	16	125	16.3	20				
6013521	AS-ZCC2-L-2020-3-T12	20	20	125	20.3	12				
6013522	AS-ZCC2-L-2020-3-T20	20	20	125	20.3	20				
6013523	AS-ZCC2-L-2020-3-R21	20	20	125	20.3	21				
6013524	AS-ZCC2-L-2020-3-R25	20	20	125	20.3	25				
6013525	AS-ZCC2-L-2525-3-T12	25	25	150	25.3	12				
6013526	AS-ZCC2-L-2525-3-T22	25	25	150	25.3	22				
6013527	AS-ZCC2-L-2525-3-R30	25	25	150	25.3	30				
6013528	AS-ZCC2-L-2020-4-T12	20	20	125	20.5	12	Z.GD - 4	6211241	-	6211588
6013529	AS-ZCC2-L-2020-4-T20	20	20	125	20.5	20				
6013530	AS-ZCC2-L-2525-4-T12	25	25	150	25.5	12				
6013531	AS-ZCC2-L-2525-4-T22	25	25	150	25.5	22	Z.HD - 5	6211241	-	6211588
6013532	AS-ZCC2-L-2020-5-T12	20	20	125	20.5	12				
6013533	AS-ZCC2-L-2020-5-T20	20	20	125	20.5	20				
6013534	AS-ZCC2-L-2525-5-T12	25	25	150	25.5	12				
6013535	AS-ZCC2-L-2525-5-T25	25	25	150	25.5	25	Z.KD - 6	6211241	-	6211588
6013536	AS-ZCC2-L-3232-5-T25	32	32	170	32.5	25				
6013537	AS-ZCC2-L-2020-6-T20	20	20	125	20.6	20				
6013538	AS-ZCC2-L-2525-6-T25	25	25	150	25.6	25				
6013539	AS-ZCC2-L-3232-6-T25	32	32	170	32.6	25	Z.KD - 6	6211241	-	6211588
6013540	AS-ZCC2-L-3232-6-T30	32	32	170	32.6	30				

Kompatibel mit ZCC Wendepplatten. / Compatible with ZCC inserts.

AS-I-R

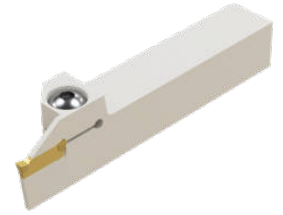
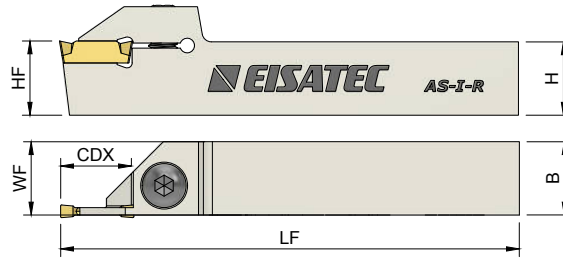
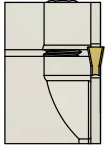



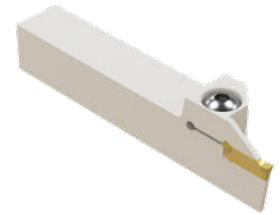
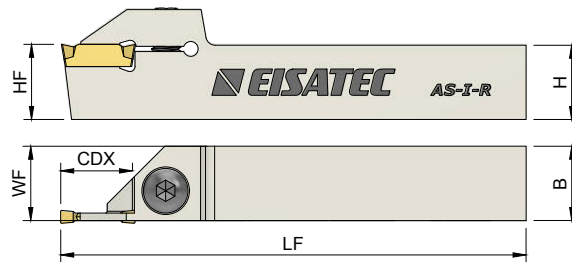
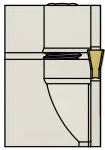

Artikelnummer Product Code	Bezeichnung Product Name	Abmessungen (mm) Dimensions (mm)					Wendeschneidplatte Insert	Klemmschraube Screw	Scheibe Washer	Innensechskantschlüssel Allen Key
		HF=H	B	LF	WF	CDX				
6013414	AS-I-R-1212-2-T15	12	12	125	16,3	15	DGN - 2	6211213	6211540	6211587
6013390	AS-I-R-1616-2-T15	16	16	100	16,3	15				
6013392	AS-I-R-2020-2-T15	20	20	125	20,3	15				
6013394	AS-I-R-2525-2-T15	25	25	150	25,3	15	DGN-3			
6013468	AS-I-R-3232-2-T15	32	32	170	32,3	15				
6013408	AS-I-R-1212-3-T15	12	12	100	16,3	15				
6013396	AS-I-R-1616-3-T15	16	16	125	16,3	15	DGN-3			
6013952	AS-I-R-2020-3-T12	20	20	125	20,3	12				
6013398	AS-I-R-2020-3-T20	20	20	125	20,3	20				
6013954	AS-I-R-2525-3-T12	25	25	150	25,3	12	DGN/GRP-4	6211241	-	6211588
6013400	AS-I-R-2525-3-T22	25	25	150	25,3	22				
6013471	AS-I-R-3232-3-T22	32	32	170	32,3	22				
6013402	AS-I-R-2020-4-T20	20	20	125	20,4	20	DGN/GRP-5			
6013956	AS-I-R-2525-4-T12	25	25	150	25,4	12				
6013404	AS-I-R-2525-4-T22	25	25	150	25,4	22				
6013445	AS-I-R-3232-4-T25	32	32	170	32,4	25	GRP-3			
6013432	AS-I-R-2020-5-T20	20	20	125	20,5	20				
6013958	AS-I-R-2525-5-T12	25	25	150	25,5	12				
6013436	AS-I-R-2525-5-T25	25	25	150	25,5	25	GIM / GIP-2	6211213	6211540	
6013460	AS-IG-R-1616-3-T18	16	16	125	16,3	18				
6013962	AS-IG-R-2020-3-T12	20	20	125	20,3	12				
6013435	AS-IG-R-2020-3-R20	20	20	125	20,3	20	GIM / GIP-3	6211241	-	6211587
6013964	AS-IG-R-2525-3-T12	25	25	150	25,3	12				
6013419	AS-IG-R-2525-3-T22	25	25	150	25,3	22				
6013411	AS-IGI-R-2020-2-T15	20	20	125	20,3	15	GIM / GIP-4			
6013412	AS-IGI-R-2525-2-T15	25	25	150	25,3	15				
6013407	AS-IGI-R-1616-3-T15	16	16	125	16,3	15				
6013423	AS-IGI-R-2020-3-T20	20	20	125	20,3	20	GIM / GIP-5			
6013960	AS-IGI-R-2525-3-T9	25	25	150	25,3	9				
6013409	AS-IGI-R-2525-3-T22	25	25	150	25,3	22				
6013440	AS-IGI-R-2525-4-T22	25	25	150	25,4	22	GIM / GIP-8	6211459		6211589
6013406	AS-IGI-R-2525-5-T25	25	25	150	25,5	25				
6013389	AS-IGI-R-2525-8-T25	25	25	150	25,8	25				
6013438	AS-IGI-R-2525-8-T30	25	25	150	25,8	30	GTN-5	6211241		6211587
6013410	AS-IGTN-R-2525-5-T25	25	25	150	25,6	25				
6013290	AS-IDC-R-2020-2-R23	20	20	125	20,2	23				
6013782	AS-IDC-R-2525-2-R23	25	25	150	25,2	23	DCE-2	6211213	6211213	6211587
6013452	AS-IDC-R-2525-3-T21	25	25	150	25,4	21				
							DCE-3	6211241		6211588

Kompatibel mit IS Wendepplatten. / Compatible with IS inserts.

AS-I-L





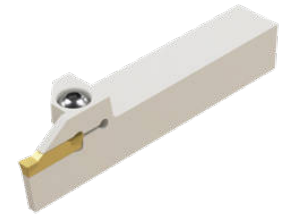
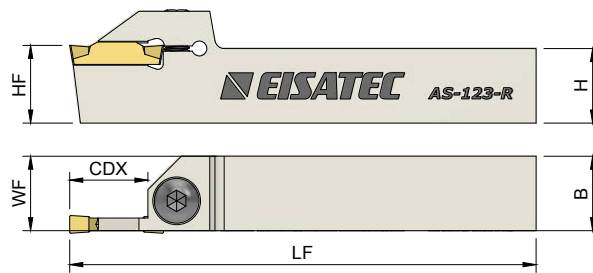
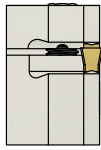

Artikelnummer Product Code	Bezeichnung Product Name	Abmessungen (mm) Dimensions (mm)					Wendeschneidplatte Insert	Klemmschraube Screw	Scheibe Washer	Innensechskantschlüssel Allen Key
		HF=H	B	LF	WF	CDX				
6013421	AS-I-L-1212-2-T15	12	12	125	16,3	15	DGN - 2	6211213	6211540	6211587
6013391	AS-I-L-1616-2-T15	16	16	100	16,3	15				
6013393	AS-I-L-2020-2-T15	20	20	125	20,3	15				
6013395	AS-I-L-2525-2-T15	25	25	150	25,3	15	DGN-3			
6013467	AS-I-L-3232-2-T15	32	32	170	32,3	15				
6013413	AS-I-L-1212-3-T15	12	12	100	16,3	15				
6013397	AS-I-L-1616-3-T15	16	16	125	16,3	15				
6013953	AS-I-L-2020-3-T12	20	20	125	20,3	12				
6013399	AS-I-L-2020-3-T20	20	20	125	20,3	20				
6013955	AS-I-L-2525-3-T12	25	25	150	25,3	12				
6013401	AS-I-L-2525-3-T22	25	25	150	25,3	22				
6013951	AS-I-L-3232-3-T22	32	32	170	32,3	22				
6013403	AS-I-L-2020-4-T20	20	20	125	20,4	20				
6013957	AS-I-L-2525-4-T12	25	25	150	25,4	12	DGN/GRP-4	6211241	-	6211588
6013405	AS-I-L-2525-4-T22	25	25	150	25,4	22				
6013461	AS-I-L-3232-4-T25	32	32	170	32,4	25				
6013433	AS-I-L-2020-5-T20	20	20	125	20,5	20	DGN/GRP-5			
6013959	AS-I-L-2525-5-T12	25	25	150	25,5	12				
6013437	AS-I-L-2525-5-T25	25	25	150	25,5	25	GRP-3			
6013469	AS-IG-L-1616-3-T18	16	16	125	16,3	18				
6013963	AS-IG-L-2020-3-T12	20	20	125	20,3	12				
6013434	AS-IG-L-2020-3-R20	20	20	125	20,3	20				
6013965	AS-IG-L-2525-3-T12	25	25	150	25,3	12				
6013453	AS-IG-L-2525-3-T22	25	25	150	25,3	22	GIM / GIP-2	6211213	6211540	
6013420	AS-IGI-L-2020-2-T15	20	20	125	20,3	15				
6013454	AS-IGI-L-2525-2-T15	25	25	150	25,3	15	GIM / GIP-3	6211241		6211587
6013422	AS-IGI-L-1616-3-T15	16	16	125	16,3	15				
6013424	AS-IGI-L-2020-3-T20	20	20	125	20,3	20				
6013961	AS-IGI-L-2525-3-T9	25	25	150	25,3	9				
6013418	AS-IGI-L-2525-3-T22	25	25	150	25,3	22				
6013439	AS-IGI-L-2525-4-T22	25	25	150	25,4	22	GIM / GIP-4			
6013415	AS-IGI-L-2525-5-T25	25	25	150	25,5	25	GIM / GIP-5			
6013456	AS-IGTN-L-2525-5-T25	25	25	150	25,8	25	GTN-5	6211241	6211213	6211587
6013459	AS-IDC-L-1616-2-D35	25	25	150	25,8	30	DCE-2	6211452		6211588
6013458	AS-IDC-L-1616-3-D35	25	25	150	25,6	25	DCE-3	6211457		6211587
6013463	AS-IDC-L-2525-3-T21	20	20	125	20,2	23		6211241	6211588	

Kompatibel mit IS Wendeplatten. / Compatible with IS inserts.

AS-123-R



Artikelnummer Product Code	Bezeichnung Product Name	Abmessungen (mm) Dimensions (mm)					Wendeschneidplatte Insert	Klemmschraube Screw	Scheibe Washer	Innensechskantschlüssel Allen Key
		HF=H	B	LF	WF	CDX				
6013572	AS-123-R-1212-1,5-R15	12	12	100	12,2	15	123 - 1.5	6211213	6211540	6211587
6013573	AS-123-R-1616-1,5-R15	16	16	125	16,2	15				
6013567	AS-123-R-1616-2-T15	16	16	125	16,2	15				
6013579	AS-123-R-2020-2-T8	20	20	125	20,2	8				
6013549	AS-123-R-2020-2-T15	20	20	125	20,2	15				
6013583	AS-123-R-2525-2-T8	25	25	150	25,2	8				
6013551	AS-123-R-2525-2-T15	25	25	150	25,2	15	123 - 3	6211241	*	6211588
6013570	AS-123-R-3232-2-T15	32	32	170	32,2	15				
6013585	AS-123-R-1616-3-T10	16	16	125	16,3	10				
6013568	AS-123-R-1616-3-T15	16	16	125	16,3	15				
6013587	AS-123-R-2020-3-T10	20	20	125	20,3	10				
6013591	AS-123-R-2020-3-T15	20	20	125	20,3	15				
6013553	AS-123-R-2020-3-T20	20	20	125	20,3	20				
6013589	AS-123-R-2525-3-T10	25	25	150	25,3	10				
6013548	AS-123-R-2525-3-T15	25	25	150	25,3	15				
6013555	AS-123-R-2525-3-T22	25	25	150	25,3	22				
6013557	AS-123-R-2020-4-T20	20	20	125	20,4	20				
6013594	AS-123-R-2525-4-T13	25	25	150	25,4	13				
6013559	AS-123-R-2525-4-T22	25	25	150	25,4	22	123 - 4	6211241	*	6211588
6013569	AS-123-R-3232-4-T25	32	32	170	32,4	25				
6013561	AS-123-R-2020-5-T20	20	20	125	20,5	20				
6013563	AS-123-R-2525-5-T25	25	25	150	25,5	25	123 - 5	6211241	*	6211588
6013578	AS-123-R-3232-6-T15	32	32	170	32,5	15				
6013411	AS-IGI-R-2020-2-T15	20	20	125	20,3	15	GIM / GIP-2	6211213	6211540	6211587

Kompatibel mit SN Wendepplatten / Compatible with SN Insert.

AS-123-L

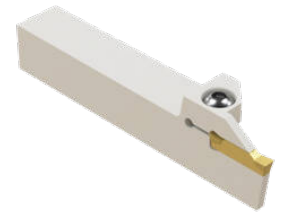
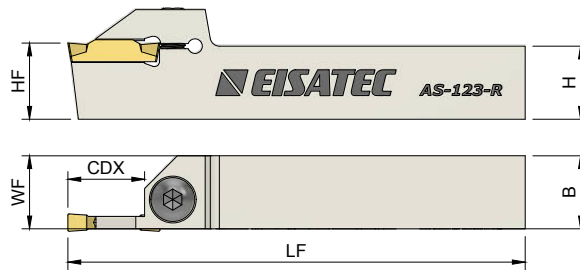
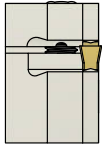

Artikelnummer Product Code	Bezeichnung Product Name	Abmessungen (mm) Dimensions (mm)					Wendeschneidplatte Insert	Klemmschraube Screw	Scheibe Washer	Innensechskantschlüssel Allen Key
		HF=H	B	LF	WF	CDX				
6013565	AS-123-L-1616-2-T15	16	16	125	16,2	15	123 - 1.5	6211213	6211540	6211587
6013580	AS-123-L-2020-2-T8	20	20	125	20,2	8				
6013550	AS-123-L-2020-2-T15	20	20	125	20,2	15				
6013584	AS-123-L-2525-2-T8	25	25	150	25,2	8				
6013552	AS-123-L-2525-2-T15	25	25	150	25,2	15				
6013575	AS-123-L-3232-2-T15	32	32	170	32,2	15				
6013586	AS-123-L-1616-3-T10	16	16	125	16,3	10	123 - 3	6211241	-	6211588
6013566	AS-123-L-1616-3-T15	16	16	125	16,3	15				
6013588	AS-123-L-2020-3-T10	20	20	125	20,3	10				
6013592	AS-123-L-2020-3-T15	20	20	125	20,3	15				
6013554	AS-123-L-2020-3-T20	20	20	125	20,3	20				
6013590	AS-123-L-2525-3-T10	25	25	150	25,3	10				
6013593	AS-123-L-2525-3-T15	25	25	150	25,3	15				
6013556	AS-123-L-2525-3-T22	25	25	150	25,3	22				
6013558	AS-123-L-2020-4-T20	20	20	125	20,4	20				
6013595	AS-123-L-2525-4-T13	25	25	150	25,4	13				
6013560	AS-123-L-2525-4-T22	25	25	150	25,4	22	123 - 4			
6013574	AS-123-L-3232-4-T25	32	32	170	32,4	25				
6013562	AS-123-L-2020-5-T20	20	20	125	20,5	20	123 - 5			
6013564	AS-123-L-2525-5-T25	25	25	150	25,5	25				
6013581	AS-123-L-3232-6-T15	32	32	170	32,5	15	123 - 6			
6013420	AS-IGI-L-2020-2-T15	20	20	125	20,3	15				
							GIM / GIP-2	6211213	6211540	6211587

Kompatibel mit SN Wendepplatten / Compatible with SN Insert.

AS-TD-R/L

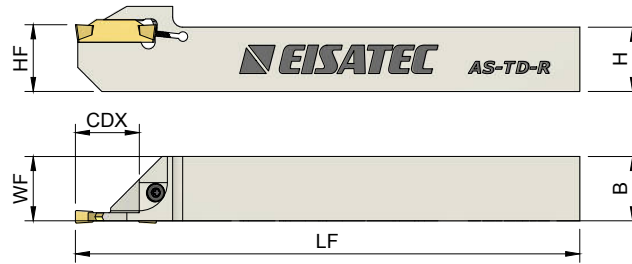
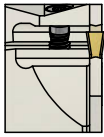

Artikelnummer Product Code	Bezeichnung Product Name	Abmessungen (mm) Dimensions (mm)					Wendeschneidplatte Insert	Klemmschraube Screw	Torx-Schlüssel Torx Key
		HF=H	B	LF	WF	CDX			
6013738	AS-TD-R-1010-2-R10-K-S	10	10	125	10,2	10	TD.-2	6211385	6211604
6013692	AS-TD-R-1212-2-T12-K-S	12	12	125	12,2	12			
6013696	AS-TD-R-1616-2-T16-K-S	16	16	125	16,2	16			
6013689	AS-TD-R-1212-3-T12-K-S	12	12	125	12,3	12	TD.-3	6211385	6211604
6013694	AS-TD-R-1616-3-T16-K-S	16	16	125	16,3	16			
6013691	AS-TD-L-1212-2-T12-K-S	12	12	125	12,2	12	TD.-2	6211385	6211604
6013697	AS-TD-L-1616-2-T16-K-S	16	16	125	16,2	16			
6013690	AS-TD-L-1212-3-T12-K-S	12	12	125	12,3	12			
6013695	AS-TD-L-1616-3-T16-K-S	16	16	125	16,3	16			

Kompatibel mit TT Wendepplatten / Compatible with TT inserts.

AS-I-R/L

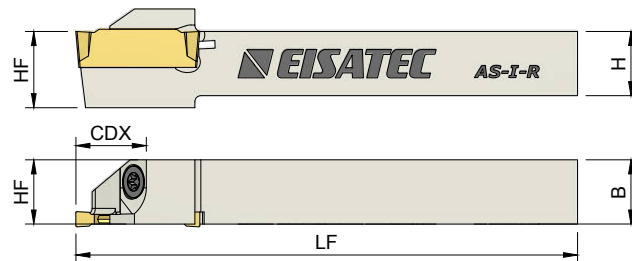

Artikelnummer Product Code	Bezeichnung Product Name	Abmessungen (mm) Dimensions (mm)					Wendeschneidplatte Insert	Klemmschraube Screw	Torx-Schlüssel Torx Key
		HF=H	B	LF	WF	CDX			
6013446	AS-I-R-0808-2-R10-S	8	8	100	8,2	10	DGN - 2	6211385	6211604
6013441	AS-I-R-1010-2-R10-K-S	10	10	125	10,2	10			
6013451	AS-I-R-1212-2-R12-K-S	12	12	125	12,2	12			
6013465	AS-I-R-1616-2-R16-K-S	16	16	125	16,2	16	DGN - 3	6211385	6211604
6013462	AS-I-R-1616-3-R16-K-S	16	16	125	16,3	16			
6013447	AS-I-L-0808-2-R10-S	8	8	100	8,2	10	DGN - 2	6211385	6211604
6013442	AS-I-L-1010-2-R10-K-S	10	10	125	10,2	10			
6013449	AS-I-L-1212-2-R12-K-S	12	12	125	12,2	12			
6013466	AS-I-L-1616-2-R16-K-S	16	16	125	16,2	16			
6013448	AS-I-L-1616-3-R16-K-S	16	16	125	16,3	16	DGN - 3		

Kompatibel mit IS Wendepplatten. / Compatible with IS inserts.

SW-TD

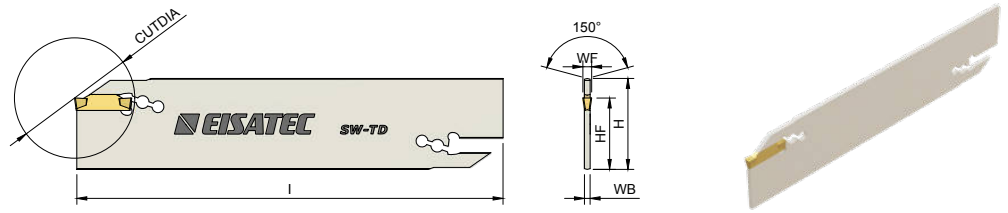

Artikelnummer Product Code	Bezeichnung Product Name	Abmessungen (mm) Dimensions (mm)							Wendeschneidplatte Insert	Innensechskantschlüssel Allen Key
		H	WF	WB2	WB	I	HF	CUTDIA		
6014356	SW-TD-32-2	32	2	2.4	1.6	150	25	39	TD. - 2	6211580
6018264	SW-TD-26-3	26	3	-	2.40	150	26	40	TD. - 3	
6014357	SW-TD-32-3	32	3	2.4	-	150	25	39	TD. - 4	
6014358	SW-TD-26-4	26	4	-	3.20	150	26	40	TD. - 5	
6014359	SW-TD-32-5	32	5	-	4	150	25	40	TD. - 5	

Kompatibel mit TT Wendepplatten / Compatible with TT inserts.

SW-I

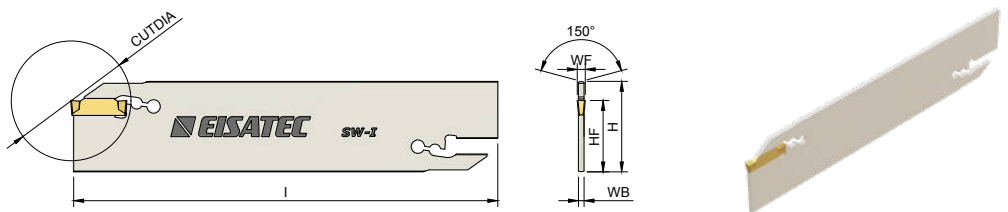

Artikelnummer Product Code	Bezeichnung Product Name	Abmessungen (mm) Dimensions (mm)							Wendeschneidplatte Insert	Innensechskantschlüssel Allen Key
		H	WF	WB2	WB	I	HF	CUTDIA		
6014344	SW-I-26-2	26	1.9-2.5	1.6	-	110	21.4	39	DGN - 2	6211580
6014345	SW-I-32-2	32	1.9-2.5	1.6	2.4	150	25	39	DGN - 3	
6014346	SW-I-26-3	26	3-3-18	2.4	-	110	21.4	39	DGN / GRP - 4	
6014347	SW-I-32-3	32	3-3-18	2.4	-	150	25	39		
6014348	SW-I-26-4	26	4	3.2	-	110	21.4	80		
6014349	SW-I-32-4	32	4	3.2	-	150	25	100		

Kompatibel mit IS Wendepplatten. / Compatible with IS inserts.

SW-K

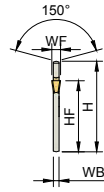
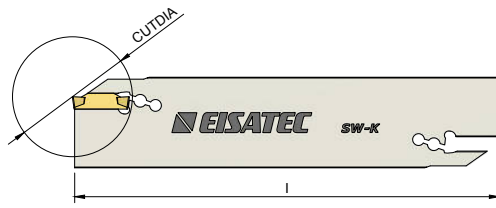

Artikelnummer Product Code	Bezeichnung Product Name	Abmessungen (mm) Dimensions (mm)							Wendeschneidplatte Insert	Innensechskantschlüssel Allen Key
		H	WF	WB2	WB	I	HF	CUTDIA		
6014352	SW-K-32-2	32	2	2.40	1.60	150	25	32	MGM.-2	6211582
6014351	SW-K-32-3	32	3	-	2.40	150	25	42	MGM.-3	
6014350	SW-K-32-4	32	4	-	3.20	150	25	42	MGM.-4	

Kompatibel mit KR Wendepplatten. / Compatible with KR Insert.

SW-SP

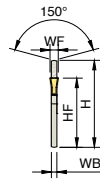
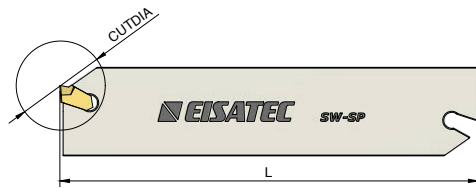



Artikelnummer Product Code	Bezeichnung Product Name	Abmessungen (mm) Dimensions (mm)							Wendeschneidplatte Insert	Innensechskantschlüssel Allen Key
		H	WF	WB2	WB	L	HF	CUTDIA		
6014369	SW-SP-26-2	26	2	-	1.60	150	21	-	SP200N	6211581
6014370	SW-SP-26-3	26	3	-	2.40	150	21	-	SP300N	
6014371	SW-SP-32-3	32	3	-	2.40	150	25	-	SP300N	
6014372	SW-SP-32-4	32	4	-	3.20	150	25	-	SP400N	

Kompatibel mit KR Wendepplatten. / Compatible with KR Insert.

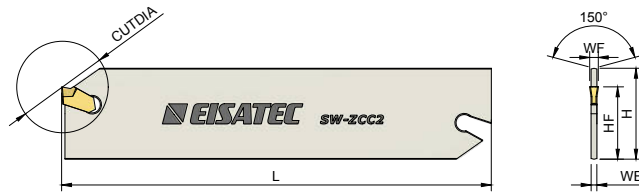
SW-ZCC2







Artikelnummer Product Code	Bezeichnung Product Name	Abmessungen (mm) Dimensions (mm)							Wendeschneidplatte Insert	Innensechskantschlüssel Allen Key
		H	WF	WB2	WB	L	HF	CUTDIA		
6014361	SW-ZCC2-32-3	32	3	-	2.40	150	25	39	Z.FD-3	6211580
6014363	SW-ZCC2-32-4	32	4	-	3.20	150	25	50.8	Z.FD-4	
6014364	SW-ZCC2-32-5	32	5	-	4	150	25	50.8	Z.FD-5	

Kompatibel mit ZCC Wendepplatten./ Compatible with ZCC inserts.

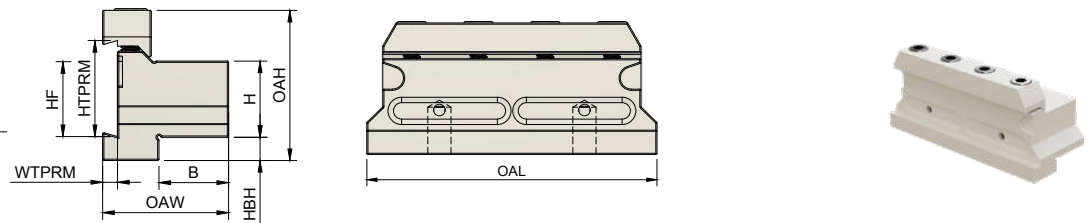
Stechschwertaufnahme
Tool Block for Parting Blades

SBS



Artikelnummer Product Code	Bezeichnung Product Name	Abmessungen (mm) Dimensions (mm)									Spannpratze Wedge Clamp	Klemmschraube Screw	Innensechskantschlüssel Allen Key
		HTPRM	HF	H	HBH	OAH	WTPRM	OAL	B	OAW			
6014340	SBS-20-26	26	21.4	20	9	43	4	86	19	38	6211570	6211460	6211589
6014338	SBS-25-26	26	21.4	25	5	45	4	110	23	42	6211572	6211461	
6014339	SBS-20-32	32	25	20	13	50	5.3	100	19	38	6211571		
6014336	SBS-25-32	32	25	25	8	50	5.3	110	23	42	6211573		
6014337	SBS-32-32	32	25	32	5	54	5.3	110	29	48			



WERKZEUGE ZUM INNENEINSTECHEN
INTERNAL GROOVING TOOLS



IS-K-R/L

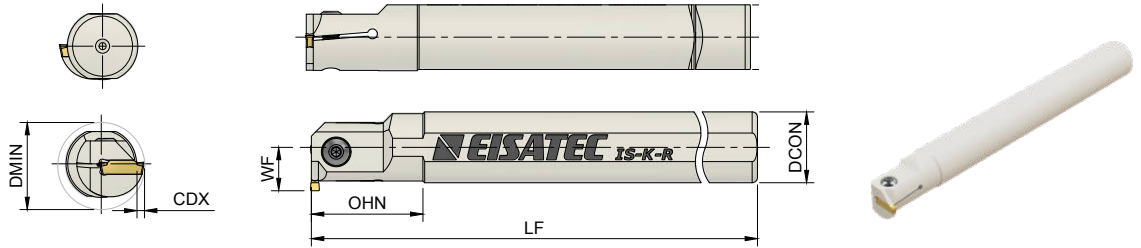

Artikelnummer Product Code	Bezeichnung Product Name	Abmessungen (mm) Dimensions (mm)							Wendeschneidplatte Insert	Klemmschraube Screw	Innensechskantschlüssel Allen Key
		DCON	DMIN	LF	OHN	CDX	H	WF			
6014018	IS-K-R-16-2-T4	16	21	150	28	4	14.8	12	MGM. - 2	6211450	6211587
6014019	IS-K-R-20-2-T4	20	25	170	30	4	18.3	14		6211453	
6014053	IS-K-R-25-2-T6	25	32	200	40	6	23	18.5	MGM. - 3	6211456	6211588
6014020	IS-K-R-20-3-T6	20	27	170	30	6	18.3	16		6211455	
6014044	IS-K-R-20-3-T7	20	25	170	38	7	18.3	13			
6014021	IS-K-R-25-3-T6	25	32	200	40	6	23	18.5		6211456	
6014047	IS-K-R-25-3-T10	25	32	200	48	10	23	17			
6014022	IS-K-R-32-3-T6	32	39	250	50	6	30	22		6211241	
6014048	IS-K-R-32-3-T12	32	39	250	53	12	30	22			
6014023	IS-K-R-40-3-T6	40	47	300	55	6	37.5	26		6211455	
6014051	IS-K-R-40-3-T12	40	48	300	63	12	37.5	27			
6014024	IS-K-R-20-4-T6	20	27	170	30	6	18.3	16		MGM. - 4	
6014045	IS-K-R-20-4-T7	20	25	170	38	7	18.3	13	6211455		
6014025	IS-K-R-25-4-T6	25	32	200	40	6	23	18.5		6211241	
6014046	IS-K-R-25-4-T10	25	32	200	49	10	23	17	6211455		
6014026	IS-K-R-32-4-T6	32	39	250	50	6	30	22		6211241	
6014049	IS-K-R-32-4-T12	32	39	250	53	12	30	22	MGM. - 5		6211588
6014027	IS-K-R-40-4-T6	40	47	300	55	6	37.5	26		6211455	
6014050	IS-K-R-40-4-T12	40	48	300	63	12	37.5	27	6211241		
6014028	IS-K-R-25-5-T7	25	33	200	40	7	23	19.5		MGM. - 5	6211588
6014029	IS-K-R-32-5-T7	32	40	250	50	7	30	23	6211455		
6014030	IS-K-R-40-5-T7	40	48	300	55	7	37.5	27		6211241	
6014062	IS-K-R-40-5-T12	40	48	300	63	12	37.5	27			
6014037	IS-K-L-16-2-T4	16	21	150	28	4	14.8	12	MGM. - 2	6211450	6211587
6014033	IS-K-L-20-2-T4	20	25	170	30	4	18.3	14		6211453	
6014055	IS-K-L-25-2-T6	25	32	200	40	6	23	18.5	MGM. - 3	6211456	6211588
6014036	IS-K-L-20-3-T6	20	27	170	30	6	18.3	16		6211455	
6014056	IS-K-L-20-3-T7	20	25	170	38	7	18.3	13			
6014035	IS-K-L-25-3-T6	25	32	200	40	6	23	18.5		6211456	
6014057	IS-K-L-25-3-T10	25	32	200	48	10	23	17			
6014039	IS-K-L-32-3-T6	32	39	250	50	6	30	22		6211241	
6014054	IS-K-L-32-3-T12	32	39	250	53	12	30	22			
6014043	IS-K-L-40-3-T6	40	47	300	55	6	37.5	26		6211455	
6014061	IS-K-L-40-3-T12	40	48	300	63	12	37.5	27			
6014041	IS-K-L-20-4-T6	20	27	170	30	6	18.3	16		MGM. - 4	
6014060	IS-K-L-20-4-T7	20	25	170	38	7	18.3	13	6211455		
6014031	IS-K-L-25-4-T6	25	32	200	40	6	23	18.5		6211241	
6014058	IS-K-L-25-4-T10	25	32	200	49	10	23	17	6211455		
6014038	IS-K-L-32-4-T6	32	39	250	50	6	30	22		6211241	
6014059	IS-K-L-32-4-T12	32	39	250	53	12	30	22	MGM. - 5		6211588
6014042	IS-K-L-40-4-T6	40	47	300	55	6	37.5	26		6211455	
6014052	IS-K-L-40-4-T12	40	48	300	63	12	37.5	27	6211241		
6014032	IS-K-L-25-5-T7	25	33	200	40	7	23	19.5		MGM. - 5	6211588
6014040	IS-K-L-32-5-T7	32	40	250	50	7	30	23	6211455		
6014034	IS-K-L-40-5-T7	40	48	300	55	7	37.5	27		6211241	
6014063	IS-K-L-40-5-T12	40	48	300	63	12	37.5	27			

Kompatibel mit KR Wendepplatten. / Compatible with KR Insert.

IS-KG-R/L

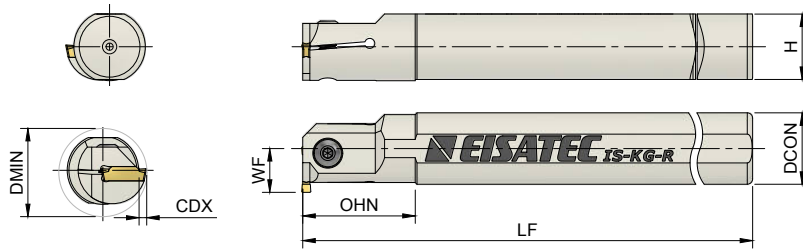

Artikelnummer Product Code	Bezeichnung Product Name	Abmessungen (mm) Dimensions (mm)							Wendeschneidplatte Insert	Klemmschraube Screw	Innensechskant-Schlüssel Allen Key
		DCON	DMIN	LF	OHN	CDX	H	WF			
6014275	IS-KG-R-25-2-T7	25	33	200	40	7	23	19.5	KG.. - 2	6211456	6211588
6014279	IS-KG-R-20-3-T6.5-H	20	27.5	170	30	6.5	18.3	16.5	KG.. - 3	6211455	
6014280	IS-KG-R-40-3-T8	40	50	300	55	8	37.5	28		6211241	
6014277	IS-KG-R-25-4-T8	25	34	200	40	8	23	20.5	KG.. - 4	6211455	
6014276	IS-KG-L-25-2-T7	25	33	200	40	7	23	19.5	KG.. - 2	6211456	6211588
6014284	IS-KG-L-20-3-T6.5-H	20	27.5	170	30	6.5	18.3	16.5	KG.. - 3	6211455	
6014283	IS-KG-L-40-3-T8	40	50	300	55	8	37.5	28		6211241	
6014278	IS-KG-L-25-4-T8	25	34	200	40	8	23	20.5	KG.. - 4	6211455	

Kompatibel mit KR / Compatible with KR Insert.

IS-151.23-R/L

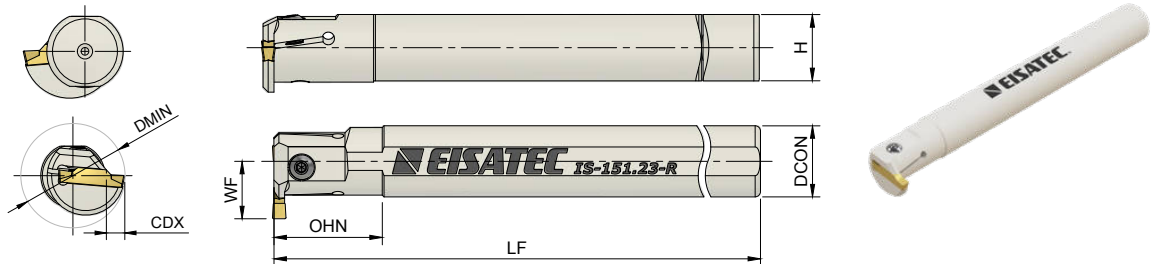

Artikelnummer Product Code	Bezeichnung Product Name	Abmessungen (mm) Dimensions (mm)							Wendeschneidplatte Insert	Klemmschraube Screw	Innensechskantschlüssel Allen Key
		DCON	DMIN	LF	OHN	CDX	H	WF			
6014273	IS-151.23-R-20-2-T6	20	32	170	30	6	18.3	16	151.23 - 2	6211453	6211587
6014274	IS-151.23-R-20-2.5-T6	20	32	170	30	6	18.3	16	151.23 - 2.5		
6014272	IS-151.22-L-25-3-T6	25	37	200	32	6	23	18,5	151.23 - 3	6211453	6211587
6014271	IS-151.22-L-25-3-T6-H	25	37	200	32	6	23	18,5			

Kompatibel mit SN Wendeplatten. / Compatible with SN Insert.

IS-154.91-R/L

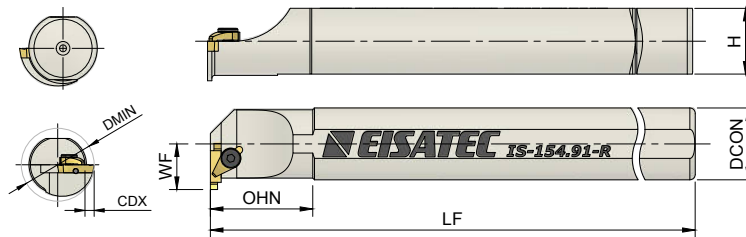

Artikelnummer Product Code	Bezeichnung Product Name	Abmessungen (mm) Dimensions (mm)							Wendeschneidplatte Insert	Spannpratze Wedge Clamp	Klemmschraube Screw	Stift Pin	Innensechskant- Schlüssel Allen Key
		DCON	DMIN	LF	OHN	CDX	H	WF					
6014099	IS-154.91-R-16-3-T3	16	20	150	35	3	14.8	11	154.91 - 3	6211126	6211202	6211520	6211588
6014101	IS-154.91-R-20-3-T4	20	25	170	38	4	18.3	14					
6014103	IS-154.91-R-25-3-T4	25	31	200	40	4	23	16.5	154.91 - 5	6211123	6211203	6211520	6211587
6014105	IS-154.91-R-25-5-T5	25	31	200	45	5	23	17.5			6211211		
6014107	IS-154.91-R-32-5-T5	32	38	250	50	5	30	21					
6014100	IS-154.91-L-16-3-T3	16	20	150	35	3	14.8	11	154.91 - 3	6211126	6211202	6211520	6211588
6014102	IS-154.91-L-20-3-T4	20	25	170	38	4	18.3	14					
6014104	IS-154.91-L-25-3-T4	25	31	200	40	4	23	16.5	154.91 - 5	6211123	6211203	6211520	6211587
6014106	IS-154.91-L-25-5-T5	25	31	200	45	5	23	17.5			6211211		
6014108	IS-154.91-L-32-5-T5	32	38	250	50	5	30	21					

Kompatibel mit SN Wendepplatten. / Compatible with SN Insert.

IS-TD-R/L

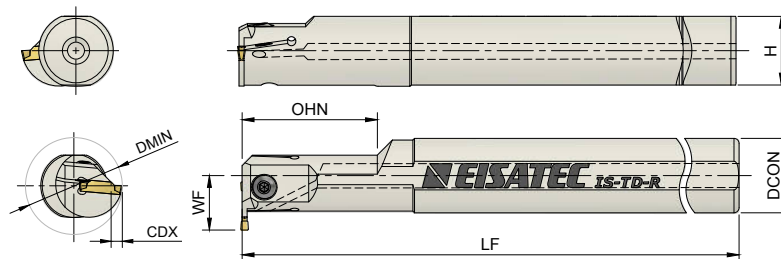

Artikelnummer Product Code	Bezeichnung Product Name	Abmessungen (mm) Dimensions (mm)							Wendeschneidplatte Insert	Klemmschraube Screw	Innensechskant- Schlüssel Allen Key
		DCON	DMIN	LF	OHN	CDX	H	WF			
6014109	IS-TD-R-16-2-T8.5-H	16	25	150	28	8.5	14.8	16.5	TD. - 2	6211450	6211587
6014110	IS-TD-R-20-3-T6-H	20	25	170	40	6	18.3	16	TD. - 3	6211456	
6014111	IS-TD-R-25-3-T6-H	25	25	200	40	6	23	18.5			6211455
6014112	IS-TD-R-32-3-T5-H	32	31	250	60	5	30	21		6211241	
6014118	IS-TD-R-20-4-T10-H	20	27	170	40	10	18.3	20	TD. - 4	6211456	6211588
6014121	IS-TD-R-25-4-T10-H	25	31	200	40	10	23	22.5		6211455	
6014122	IS-TD-R-32-4-T10-H	32	36	250	60	10	30	26		6211241	
6014113	IS-TD-L-16-2-T8.5-H	16	25	150	28	8.5	14.8	16.5	TD. - 2	6211450	6211587
6014114	IS-TD-L-20-3-T6-H	20	25	170	40	6	18.3	16	TD. - 3	6211456	
6014115	IS-TD-L-25-3-T6-H	25	25	200	40	6	23	18.5			6211455
6014116	IS-TD-L-32-3-T5-H	32	31	250	60	5	30	21		6211241	
6014117	IS-TD-L-20-4-T10-H	20	27	170	40	10	18.3	20	TD. - 4	6211456	6211588
6014120	IS-TD-L-25-4-T10-H	25	31	200	40	10	23	22.5		6211455	
6014119	IS-TD-L-32-4-T10-H	32	36	250	60	10	30	26		6211241	

Kompatibel mit TT Wendepplatten. / Compatible with TT inserts.

IS-123-R/L

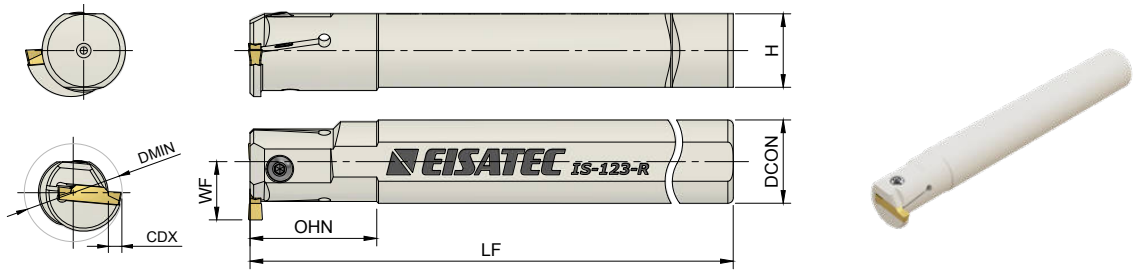



Artikelnummer Product Code	Bezeichnung Product Name	Abmessungen (mm) Dimensions (mm)							Wendeschnidplatte Insert	Klemmschraube Screw	Innensechskantschlüssel Allen Key
		DCON	DMIN	LF	OHN	CDX	H	WF			
6014262	IS-123-R-20-2-T6	20	32	170	30	6	18.3	16	123 - 2	6211453	6211587
6014263	IS-123-R-25-2-T6	25	32	200	40	6	18.3	18.5		6211456	
6014242	IS-123-R-32-2-T7	32	41	250	45	7	30	23		6211241	
6014244	IS-123-R-20-3-T6	20	32	170	30	6	18.3	16	123 - 3	6211455	6211588
6014245	IS-123-R-25-3-T7	25	32	200	40	7	23	19.5		6211241	
6014248	IS-123-R-32-3-T9	32	41	250	50	9	30	25		6211241	
6014251	IS-123-R-20-4-T8	20	29	170	30	8	18.3	18	123 - 4	6211455	
6014246	IS-123-R-25-4-T7	25	32	200	40	7	23	19.5		6211241	
6014243	IS-123-R-32-4-T7	32	41	250	45	7	30	23		6211241	
6014249	IS-123-R-32-4-T10	32	43	250	50	10	30	26	123 - 5	6211455	
6014247	IS-123-R-25-5-T8	25	34	200	40	8	23	20.5		6211455	
6014250	IS-123-R-32-5-T11	32	43	250	50	11	30	27		6211241	
6014264	IS-123-L-20-2-T6	20	32	170	30	6	18.3	16	123 - 2	6211453	6211587
6014265	IS-123-L-25-2-T6	25	32	200	40	6	18.3	18.5		6211456	
6014261	IS-123-L-32-2-T7	32	41	250	45	7	30	23		6211241	
6014253	IS-123-L-20-3-T6	20	32	170	30	6	18.3	16	123 - 3	6211455	6211588
6014252	IS-123-L-25-3-T7	25	32	200	40	7	23	19.5		6211241	
6014257	IS-123-L-32-3-T9	32	41	250	50	9	30	25		6211241	
6014254	IS-123-L-20-4-T8	20	29	170	30	8	18.3	18	123 - 4	6211455	
6014255	IS-123-L-25-4-T7	25	32	200	40	7	23	19.5		6211241	
6014260	IS-123-L-32-4-T7	32	41	250	45	7	30	23		6211241	
6014258	IS-123-L-32-4-T10	32	43	250	50	10	30	26	123 - 5	6211455	
6014256	IS-123-L-25-5-T8	25	34	200	40	8	23	20.5		6211455	
6014259	IS-123-L-32-5-T11	32	43	250	50	11	30	27		6211241	

Kompatibel mit SN Wendepplatten. / Compatible with SN Insert.

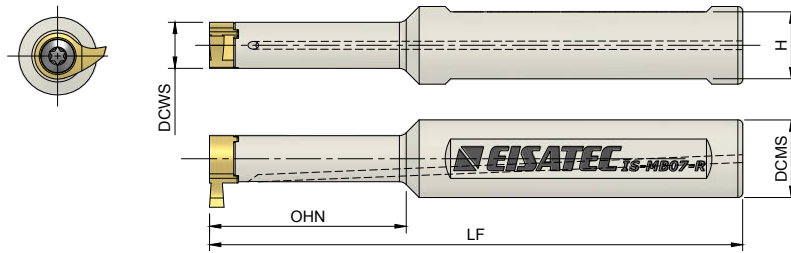
IS-MB07





Artikelnummer Product Code	Bezeichnung Product Name	Abmessungen (mm) Dimensions (mm)					Wendeschneidplatte Insert	Klemmschraube Screw	Torx-Schlüssel Torx Key
		DCMS	DCWS	LF	OHN	H			
6014266	IS-MB07-A16-090-15	16	7.4	90	15	14	MB - 07	6211350	6211602
6014267	IS-MB07-A16-090-22	16	7.4	90	22	14			
6014268	IS-MB09-A16-090-19	16	9.5	90	19	14	MB - 09	6211385	6211604
6014270	IS-MB09-A16-095-28	16	9.5	95	28	14			
6014269	IS-MB09-A16-110-40	16	9.5	110	40	14			

Kompatibel mit SN Wendepplatten. / Compatible with SN Insert.

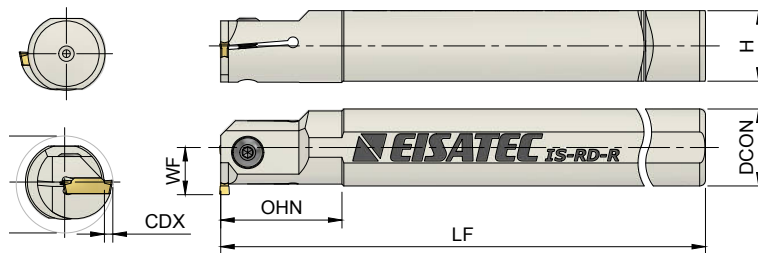
IS-RD-R





Artikelnummer Product Code	Bezeichnung Product Name	Abmessungen (mm) Dimensions (mm)							Wendeschneidplatte Insert	Klemmschraube Screw	Innenschlantschlüssel Allen Key
		DCON	DMIN	LF	OHN	CDX	H	WF			
6018197	IS-RD-R-16-2-T6	16	24	150	28	6	14.8	14	RD. - 2	6211450	6211587
6014064	IS-RD-R-20-2-T6	20	28	170	28	6	18.3	16		6211455	
6018198	IS-RD-R-25-2-T6	25	33	200	28	6	23	18.5	RD. - 3	6211450	6211588
6018199	IS-RD-R-16-3-T6	16	24	150	28	6	14.8	14		6211456	
6018200	IS-RD-R-20-3-T6	20	28	170	28	6	18.3	16		6211455	
6018201	IS-RD-R-25-3-T6	25	33	200	28	6	23	18.5	RD. - 4	6211241	6211588
6018202	IS-RD-R-32-3-T6	32	40	250	50	6	30	22		6211456	
6018203	IS-RD-R-20-4-T6	20	28	170	28	6	18.3	16	RD. - 4	6211455	6211588
6018204	IS-RD-R-25-4-T6	25	33	200	28	6	23	18.5		6211455	
6018205	IS-RD-R-32-4-T6	32	40	250	50	6	30	22		6211241	

Kompatibel mit TT Wendepplatten. / Compatible with TT inserts.

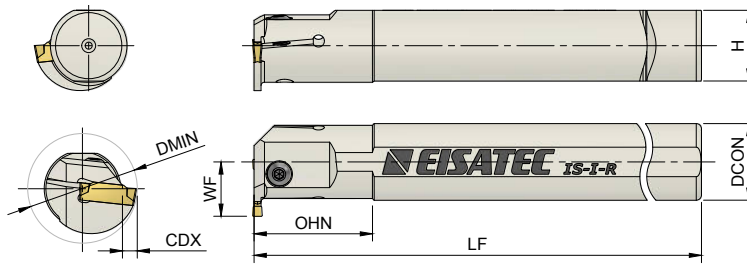
IS-I-R/L





Artikelnummer Product Code	Bezeichnung Product Name	Abmessungen (mm) Dimensions (mm)							Wendeschneidplatte Insert	Klemmschraube Screw	Innenschlantschlüssel Allen Key
		DCON	DMIN	LF	OHN	CDX	H	WF			
6014153	IS-I-R-20-3-T5	20	26	170	25	5	18,3	15,5	DGN-3	6211456	6211588
6014154	IS-I-R-25-3-T6	25	32	200	40	6	23	19		6211455	6211588
6014163	IS-I-L-20-3-T5	20	26	170	25	5	18,3	15,5	DGN-3	6211456	6211588
6014164	IS-I-L-25-3-T6	25	32	200	40	6	23	19		6211455	6211588

Kompatibel mit IS Wendeschneidplatten. / Compatible with IS inserts.

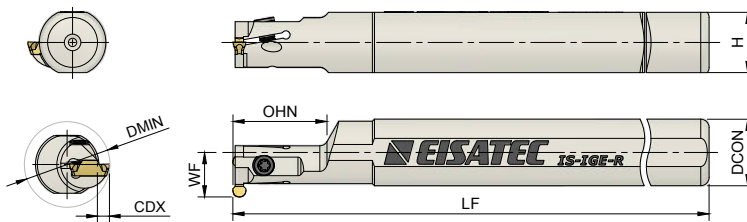
IS-IGE-R/L





Artikelnummer Product Code	Bezeichnung Product Name	Abmessungen (mm) Dimensions (mm)							Wendeschneidplatte Insert	Klemmschraube Screw	Torx-Schlüssel Torx Key
		DCON	DMIN	LF	OHN	CDX	H	WF			
6014172	IS-IGE-R-10-2-T3-H	10	11.5	125	25	3	9	8.3	GEPI - 2	6211346	6211602
6014183	IS-IGE-R-16-2-T3-D11.5	16	11.5	125	20	3	14.8	11.1		6211375	6211604
6014181	IS-IGE-R-16-2-T3-D11.5-H	16	11	125	22	3	14.8	11	GEPI - 3		
6014162	IS-IGE-R-16-3-T2.5-	16	13	125	20	2.5	14.8	10.5		GEPI - 3	6211375
6014173	IS-IGE-R-16-3-T2.5-D20	16	20	125	28	2.5	14,8	10,5	GEPI - 2		
6014176	IS-IGE-L-10-2-T3-H	10	11.5	125	25	3	9	8.3		GEPI - 2	6211346
6014185	IS-IGE-L-16-2-T3-D11.5	16	11.5	125	20	3	14.8	11.1	6211375		
6014174	IS-IGE-L-16-3-T2.5-H	16	13	125	20	2.5	14.8	10.5		GEPI - 3	6211375
6014177	IS-IGE-L-16-3-T2.5-D20	16	20	125	28	2.5	14,8	10,5	GEPI - 3		

Kompatibel mit IS Wendeschneidplatten. / Compatible with IS inserts.

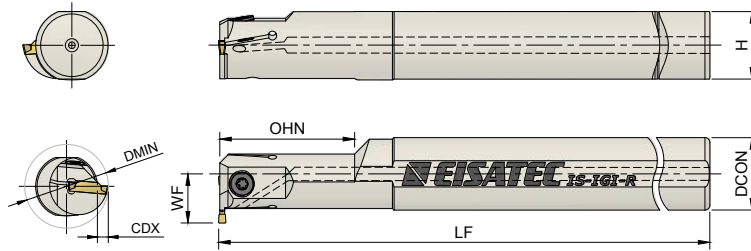
IS-IGI-R/L





Artikelnummer Product Code	Bezeichnung Product Name	Abmessungen (mm) Dimensions (mm)							Wendeschneidplatte Insert	Klemmschraube Screw	Torx-Schlüssel Torx Key
		DCON	DMIN	LF	OHN	CDX	H	WF			
6014147	IS-IGI-R-20-3-T4	20	20	170	25	4	18.3	14.5	GIMIY / GIPI - 3	6211400	6211605
6014125	IS-IGI-R-25-3-T5	25	23	200	30	5	23	17		6211455	6211588
6014159	IS-IGI-R-32-3-T5	32	31	250	30	5	30	21		6211241	
6014180	IS-IGI-R-40-3-T5	40	50	300	50	5	37.5	25	GIMIY / GIPI - 4	6211400	6211605
6014155	IS-IGI-R-20-4-T4	20	20	170	25	4	18.3	14.5			
6014168	IS-IGI-R-25-5-T10	25	32	200	25	10	23	22.5			
6014184	IS-IGI-R-25-5-T10-H	25	32	200	25	10	23	22.5	GIMIY / GIPI - 5	6211455	6211588
6014169	IS-IGI-R-25-5-T15	25	37	200	25	15	23	27.5			
6018237	IS-IGI-R-25-5-T15-H	25	37	200	25	15	23	27.5			
6014158	IS-IGI-L-20-3-T4	20	20	170	25	4	18.3	14.5	GIMIY / GIPI - 3	6211400	6211605
6014157	IS-IGI-L-25-3-T5	25	23	200	30	5	23	17		6211455	6211588
6014160	IS-IGI-L-32-3-T5	32	31	250	30	5	30	21		6211241	
6014182	IS-IGI-L-40-3-T5	40	50	300	50	5	37.5	25	GIMIY / GIPI - 4	6211400	6211605
6014156	IS-IGI-L-20-4-T4	20	20	170	25	4	18.3	14.5			
6014178	IS-IGI-L-25-5-T10-H	25	32	200	25	10	23	22.5			
6014179	IS-IGI-L-25-5-T15	25	37	200	25	15	23	27.5	GIMIY / GIPI - 5	6211455	6211588

Kompatibel mit IS Wendepplatten. / Compatible with IS inserts.

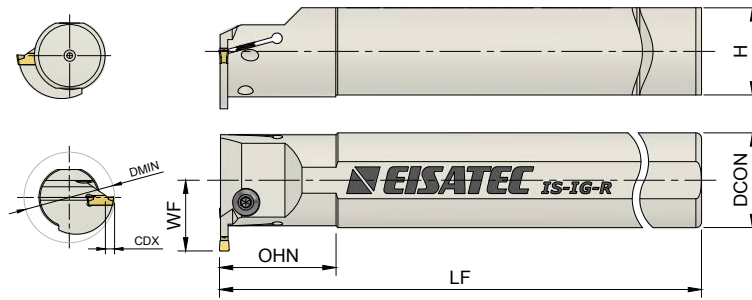
IS-IG-R/L









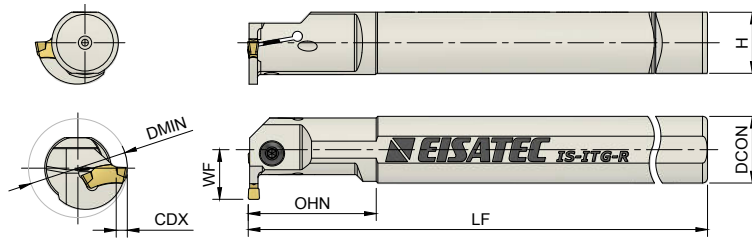











Artikelnummer Product Code	Bezeichnung Product Name	Abmessungen (mm) Dimensions (mm)							Wendeschneidplatte Insert	Klemmschraube Screw	Innenschkantschlüssel Allen Key
		DCON	DMIN	LF	OHN	CDX	H	WF			
6014141	IS-IG-R-25-4-T10-H	25	36	200	40	10	23	22.7	DGN / GRP - 4	6211455	6211588
6014142	IS-IG-R-32-4-T10-H	32	43	250	45	10	30	26.2		6211241	
6014143	IS-IG-R-40-4-T12-H	40	53	250	50	12	37.5	32.2	DGN / GRP - 5	6211455	6211588
6014144	IS-IG-R-25-5-T10-H	25	43	200	40	10	23	22.7		6211241	
6014145	IS-IG-R-32-5-T10-H	32	43	250	45	10	30	26.2			
6014124	IS-IG-R-40-5-T12-H	40	53	250	50	12	37.5	32.2			
6014123	IS-IG-R-50-5-T12-H	50	63	300	60	12	47	37.2			
6014161	IS-IG-L-25-4-T10-H	25	36	200	40	10	23	22.7	DGN / GRP - 4	6211455	6211588
6014148	IS-IG-L-32-4-T10-H	32	43	250	45	10	30	26.2		6211241	
6014149	IS-IG-L-40-4-T12-H	40	53	250	50	12	37.5	32.2	DGN / GRP - 5	6211455	6211588
6014165	IS-IG-L-25-5-T10-H	25	43	200	40	10	23	22.7		6211241	
6014166	IS-IG-L-32-5-T10-H	32	43	250	45	10	30	26.2			
6014167	IS-IG-L-40-5-T12-H	40	53	250	50	12	37.5	32.2			

Kompatibel mit IS Wendeleitungen. / Compatible with IS inserts.

IS-ITG-R/L





Artikelnummer Product Code	Bezeichnung Product Name	Abmessungen (mm) Dimensions (mm)							Wendeschneidplatte Insert	Klemmschraube Screw		Innenschkant- Schlüssel Allen Key	Torx- Schlüssel Torx Key
		DCON	DMIN	LF	OHN	CDX	H	WF					
6014126	IS-ITG-R-16-3-T6-H	16	20	150	25	6	14.8	12	TGM. - 3	6211392	6211605		
6014128	IS-ITG-R-20-3-T6-H	20	25	170	32	6	18.3	14.2		6211395			
6014132	IS-ITG-R-25-3-T8-H	25	32	200	40	8	23	18.8		6211455			
6014146	IS-ITG-R-32-3-T8-H	32	38	250	49	8	30	22	TGM. - 4	6211241	6211588		
6014130	IS-ITG-R-20-4-T6-H	20	25	170	33	6	18.3	14.2		6211395	6211605		
6014140	IS-ITG-R-25-4-T7-H	25	31	200	41	7	23	17.5	TGM. - 4	6211455	6211588		
6014134	IS-ITG-R-25-4-T9-H	25	32.5	200	41	9	23	19.5		6211241			
6014136	IS-ITG-R-32-4-T11-H	32	42	250	50	11	30	25.5	TGM. - 6.35	6211241	6211588		
6014150	IS-ITG-R-40-4-T11-H	40	53	300	50	11	37.5	32					
6014171	IS-ITG-R-32-6.35-T17.5-H	32	57	250	50	17.5	30	29	TGM. - 6.35				
6014127	IS-ITG-L-16-3-T6-H	16	20	150	25	6	14.8	12	TGM. - 3	6211392	6211605		
6014129	IS-ITG-L-20-3-T6-H	20	25	170	32	6	18.3	14.2		6211395			
6014133	IS-ITG-L-25-3-T8-H	25	32	200	40	8	23	18.8		6211455			
6014152	IS-ITG-L-32-3-T8-H	32	38	250	49	8	30	22	TGM. - 4	6211241	6211588		
6014131	IS-ITG-L-20-4-T6-H	20	25	170	33	6	18.3	14.2		6211395	6211605		
6014139	IS-ITG-L-25-4-T7-H	25	31	200	41	7	23	17.5	TGM. - 4	6211455	6211588		
6014135	IS-ITG-L-25-4-T9-H	25	32.5	200	41	9	23	19.5		6211241			
6014137	IS-ITG-L-32-4-T11-H	32	42	250	50	11	30	25.5	TGM. - 6.35	6211241	6211588		
6014151	IS-ITG-L-40-4-T11-H	40	53	300	50	11	37.5	32					
6014170	IS-ITG-L-32-6.35-T17.5-H	32	57	250	50	17.5	30	29	TGM. - 6.35				

Kompatibel mit IS Wendepfatten. / Compatible with IS inserts.

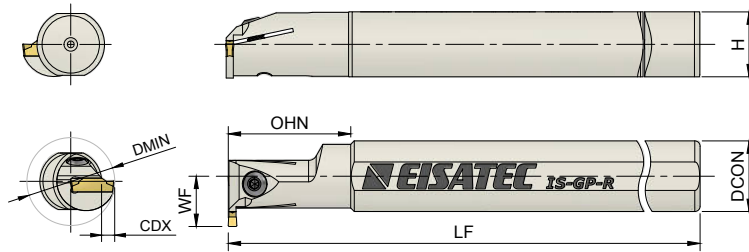
IS-GP-R/L



Artikelnummer Product Code	Bezeichnung Product Name	Abmessungen (mm) Dimensions (mm)							Wendeschneidplatte Insert	Klemmschraube Screw	Innenschkantschlüssel Allen Key
		DCON	DMIN	LF	OHN	CDX	H	WF			
6014297	IS-GP-R-20-2-T4	20	25	170	30	4	18,3	14,5	GP - 2	6211453	6211587
6014298	IS-GP-R-25-2-T6	25	32	200	40	6	23	18,5		GP - 3	6211455
6014296	IS-GP-R-20-3-T6	20	27	170	30	6	18,3	16			
6014293	IS-GP-R-25-3-T6	25	32	200	40	6	23	18,5			
6014292	IS-GP-R-32-3-T6	32	39	250	50	6	30	22			
6014295	IS-GP-R-20-4-T6	20	27	170	30	6	18,3	16			
6014294	IS-GP-R-25-4-T6	25	32	200	40	6	23	18,5			
6014291	IS-GP-R-32-4-T6	32	39	250	50	6	30	22	GP - 4		6211241
6014299	IS-GP-L-20-2-T4	20	25	170	30	4	18,3	14,5	GP - 2	6211453	6211587
6014306	IS-GP-L-25-2-T6	25	32	200	40	6	23	18,5		GP - 3	6211455
6014300	IS-GP-L-20-3-T6	20	27	170	30	6	18,3	16			
6014302	IS-GP-L-25-3-T6	25	32	200	40	6	23	18,5			
6014305	IS-GP-L-32-3-T6	32	39	250	50	6	30	22			
6014301	IS-GP-L-20-4-T6	20	27	170	30	6	18,3	16			
6014303	IS-GP-L-25-4-T6	25	32	200	40	6	23	18,5			
6014304	IS-GP-L-32-4-T6	32	39	250	50	6	30	22	GP - 4		6211241

Kompatibel mit IS Wendepplatten. / Compatible with IS inserts.

IS-ZCC2-R/L

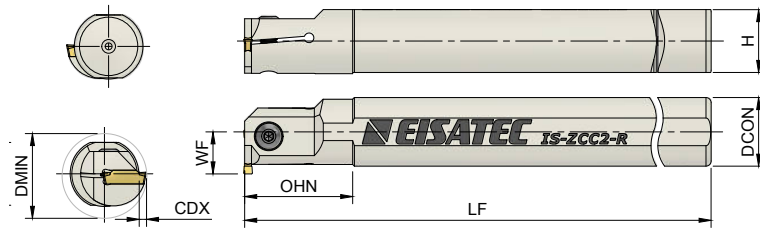

Artikelnummer Product Code	Bezeichnung Product Name	Abmessungen (mm) Dimensions (mm)							Wendeschneidplatte Insert	Klemmschraube Screw	Torx-Schlüssel Torx Key	
		DCON	DMIN	LF	OHN	CDX	H	WF				
6014207	IS-ZCC2-R-16-2-T4	16	21	150	28	4	14.8	12	Z.BD - 2	6211450	6211587	
6014194	IS-ZCC2-R-20-3-T5	20	27	170	30	5	18.3	15	Z.FD - 3	6211456	6211588	
6014220	IS-ZCC2-R-20-3-T8	20	29	170	30	8	18.3	18		6211455		
6014195	IS-ZCC2-R-25-3-T5	25	31	200	40	5	23	17.5		6211241		
6014221	IS-ZCC2-R-25-3-T10	25	36	200	40	10	23	22.5		6211456		
6014197	IS-ZCC2-R-32-3-T6	32	39	250	50	6	30	22		6211455		
6014203	IS-ZCC2-R-32-3-T8	32	41	250	50	8	30	24		Z.GD - 4		
6014219	IS-ZCC2-R-32-3-T13	32	46	250	50	13	30	29				
6014226	IS-ZCC2-R-40-3-T12	40	53	300	55	12	37.5	32				
6014196	IS-ZCC2-R-25-4-T6	25	32	200	40	6	23	18.5				6211241
6014198	IS-ZCC2-R-32-4-T7	32	40	250	50	7	30	23				
6014205	IS-ZCC2-R-32-4-T8	32	41	250	50	8	30	24	Z.HD - 5			
6014204	IS-ZCC2-R-32-4-T10	32	43	250	50	10	30	26				
6014199	IS-ZCC2-R-32-5-T7	32	40	250	50	7	30	23				
6014206	IS-ZCC2-R-32-5-T8	32	41	250	50	8	30	24				
6014200	IS-ZCC2-R-40-5-T8	40	49	300	55	8	37.5	28	Z.HD - 5			
6014202	IS-ZCC2-R-40-5-T10	40	51	300	55	10	37.5	30				
6014222	IS-ZCC2-L-16-2-T4	16	21	150	28	4	14.8	12	Z.BD - 2	6211450	6211587	
6014201	IS-ZCC2-L-20-3-T5	20	27	170	30	5	18.3	15	Z.FD - 3	6211456	6211588	
6014223	IS-ZCC2-L-20-3-T8	20	29	170	30	8	18.3	18		6211455		
6014208	IS-ZCC2-L-25-3-T5	25	31	200	40	5	23	17.5		6211241		
6014224	IS-ZCC2-L-25-3-T10	25	36	200	40	10	23	22.5		6211456		
6014210	IS-ZCC2-L-32-3-T6	32	39	250	50	6	30	22		6211455		
6014211	IS-ZCC2-L-32-3-T8	32	41	250	50	8	30	24		Z.GD - 4		
6014225	IS-ZCC2-L-32-3-T13	32	46	250	50	13	30	29				
6014227	IS-ZCC2-L-40-3-T12	40	53	300	55	12	37.5	32				
6014209	IS-ZCC2-L-25-4-T6	25	32	200	40	6	23	18.5				6211241
6014213	IS-ZCC2-L-32-4-T7	32	40	250	50	7	30	23				
6014214	IS-ZCC2-L-32-4-T8	32	41	250	50	8	30	24	Z.HD - 5			
6014212	IS-ZCC2-L-32-4-T10	32	43	250	50	10	30	26				
6014215	IS-ZCC2-L-32-5-T7	32	40	250	50	7	30	23				
6014216	IS-ZCC2-L-32-5-T8	32	41	250	50	8	30	24				
6014218	IS-ZCC2-L-40-5-T8	40	49	300	55	8	37.5	28	Z.HD - 5			
6014217	IS-ZCC2-L-40-5-T10	40	51	300	55	10	37.5	30				

Kompatibel mit ZCC Wendepplatten. / Compatible with ZCC inserts.



WENDEPLATTENBOHRER
INDEXABLE DRILLS



WB 2D16 WCM

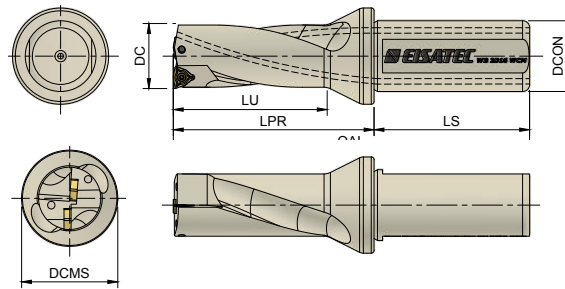

Bohrtiefe bis 2xD
Drilling depth up to 2xD

Mit Innenkühlung
With internal cooling

Artikelnummer Product Code	Bezeichnung Product Name	Abmessungen (mm) Dimensions (mm)							Max. Offset (radial)		Wendeschneidplatte Insert	Klemmschraube Screw	Torx-Schlüssel Torx Key
		DC	DCMS	OAL	LU	LPR	LS	Xmax (mm)	DC max (mm)				
6014447	WB 2D16 WCM. 03	16	25	34	110	32	54	56	1.5	19	WCM. 030208	6211333	
6014448	WB 2D16.5 WCM. 03	16.5	25	34	110	32	54	56	1.5	19.5			
6014449	WB 2D17 WCM. 03	17	25	34	112	34	56	56	1.5	20			
6014450	WB 2D17.5 WCM. 03	17.5	25	34	112	34	56	56	1.5	20.5			
6014451	WB 2D18 WCM. 03	18	25	34	114	36	58	56	1.4	20.8			
6014452	WB 2D18.5 WCM. 03	18.5	25	34	114	36	58	56	1.3	21.1			
6014453	WB 2D19 WCM. 03	19	25	34	116	38	60	56	1.2	21.4			
6014454	WB 2D19.5 WCM. 03	19.5	25	34	116	38	60	56	1.2	21.9			
6014455	WB 2D20 WCM. 04	20	25	34	118	40	62	56	1.5	23	WCM. 040208	6211333	
6014456	WB 2D20.5 WCM. 04	20.5	25	34	118	40	62	56	1.5	23.5			
6014457	WB 2D21 WCM. 04	21	25	34	120	42	64	56	1	23			
6014458	WB 2D21.5 WCM. 04	21.5	25	34	120	42	64	56	1	23.5			
6014459	WB 2D22 WCM. 04	22	25	34	122	44	66	56	1	24			
6014460	WB 2D22.5 WCM. 04	22.5	25	34	122	44	66	56	1	24.5			
6014461	WB 2D23 WCM. 04	23	25	34	124	46	68	56	1	25			
6014462	WB 2D23.5 WCM. 04	23.5	25	34	124	46	68	56	1	25.5			
6014463	WB 2D24 WCM. 05	24	25	34	126	48	70	56	1.4	26.8	WCM. 050308	6211346	
6014464	WB 2D24.5 WCM. 05	24.5	25	34	126	48	70	56	1.4	27.3			
6014465	WB 2D25 WCM. 05	25	25	34	128	50	72	56	1.45	27.9			
6014466	WB 2D25.5 WCM. 05	25.5	25	34	128	50	72	56	1.45	28.4			
6014467	WB 2D26 WCM. 05	26	25	34	130	52	74	56	1.45	28.9			
6014468	WB 2D26.5 WCM. 05	26.5	25	34	130	52	74	56	1.45	29.4			
6014469	WB 2D27 WCM. 05	27	25	34	132	54	76	56	1.45	29.9			
6014470	WB 2D27.5 WCM. 05	27.5	25	34	132	54	76	56	1.45	30.4			
6014471	WB 2D28 WCM. 05	28	25	34	134	56	78	56	1.6	31.2			
6014472	WB 2D28.5 WCM. 05	28.5	25	34	134	56	78	56	1.6	31.7			
6014473	WB 2D29 WCM. 05	29	25	34	136	58	80	56	1.65	32.3			
6014474	WB 2D29.5 WCM. 05	29.5	25	34	136	58	80	56	1.65	32.8			
6014475	WB 2D24 WCM. 05	24	25	34	126	48	70	56	1.4	26.8			
6014508	WB 2D24,5 WCM. 05	24.5	25	34	126	48	70	56	1.4	27.3			
6014476	WB 2D25 WCM. 05	25	25	34	128	50	72	56	1.45	27.9			
6014506	WB 2D25.5 WCM. 05	25.5	25	34	128	50	72	56	1.45	28.4			
6014477	WB 2D26 WCM. 05	26	25	34	130	52	74	56	1.45	28.9			
6014509	WB 2D26.5 WCM. 05	26.5	25	34	130	52	74	56	1.45	29.4			
6014478	WB 2D27 WCM. 05	27	25	34	132	54	76	56	1.45	29.9			
6014510	WB 2D27.5 WCM. 05	27.5	25	34	132	54	76	56	1.45	30.4			
6014479	WB 2D28 WCM. 05	28	25	34	134	56	78	56	1.6	31.2			
6014507	WB 2D28.5 WCM. 05	28.5	25	34	134	56	78	56	1.6	31.7			
6014413	WB 2D29 WCM. 05	29	25	34	136	58	80	56	1.65	32.3			
6014414	WB 2D29.5 WCM. 05	29.5	25	34	136	58	80	56	1.65	32.8			

Kompatibel mit ISO Wendeplatten. / Compatible with ISO inserts.

WB 2D30 WCM

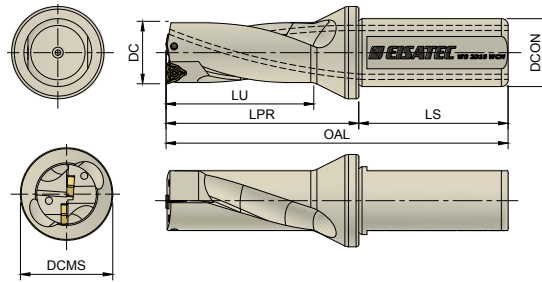

Bohrtiefe bis 2xD

Drilling depth up to 2xD

Mit Innenkühlung
With internal cooling

Artikelnummer Product Code	Bezeichnung Product Name	Abmessungen (mm) Dimensions (mm)								Max. Offset (radial)		Wendeschneidplatte Insert	Klemmschraube Screw	Torx-Schlüssel Torx Key
		DC	DCON	DCMS	OAL	LU	LPR	LS	Xmax (mm)	DC max (mm)				
6014415	WB 2D30 WCM. 06	30	32	44	147	60	87	60	2.4	34.8	WCM. 06T308	6211362	6211603	
6014416	WB 2D31 WCM. 06	31	32	44	149	62	89	60	2.3	35.6				
6014417	WB 2D32 WCM. 06	32	32	44	151	64	91	60	2.1	36.2				
6014418	WB 2D33 WCM. 06	33	32	44	153	66	93	60	1.9	36.8				
6014419	WB 2D34 WCM. 06	34	32	44	155	68	95	60	1.9	37.8				
6014420	WB 2D35 WCM. 06	35	32	44	157	70	97	60	1.9	38.8				
6014421	WB 2D36 WCM. 06	36	32	44	159	72	99	60	2	40				
6014422	WB 2D37 WCM. 06	37	32	44	161	74	101	60	1.8	40.6				
6014423	WB 2D38 WCM. 06	38	32	44	163	76	103	60	1.5	41				
6014424	WB 2D39 WCM. 06	39	32	44	165	78	105	60	1.3	41.6				
6014425	WB 2D40 WCM. 06	40	32	44	167	80	107	60	1	42				
6014426	WB 2D41 WCM. 06	41	32	44	169	82	109	60	0.8	42.6				
6014427	WB 2D42 WCM. 06	42	32	44	171	84	111	60	0.5	43				
6014428	WB 2D43 WCM. 06	43	32	44	173	86	113	60	0.3	43.6				
6014429	WB 2D44 WCM. 06	44	32	44	175	88	115	60	0	44				
6014430	WB 2D45 WCM. 08	45	40	54	192	90	122	70	3.3	51.6	WCM. 080412	6211385	6211604	
6014431	WB 2D46 WCM. 08	46	40	54	194	92	124	70	3	52				
6014432	WB 2D47 WCM. 08	47	40	54	196	94	126	70	2.8	52.6				
6014433	WB 2D48 WCM. 08	48	40	54	198	96	128	70	2.5	53				
6014434	WB 2D49 WCM. 08	49	40	54	200	98	130	70	2.2	53.4				
6014435	WB 2D50 WCM. 08	50	40	54	202	100	132	70	2	54				
6014436	WB 2D51 WCM. 08	51	40	54	204	102	134	70	1.8	54.6				
6014437	WB 2D52 WCM. 08	52	40	54	206	104	136	70	1.5	55				
6014438	WB 2D53 WCM. 08	53	40	54	208	106	138	70	1.3	55.6				
6014439	WB 2D54 WCM. 08	54	40	54	210	108	140	70	1	56				
6014440	WB 2D55 WCM. 08	55	40	54	212	110	142	70	0.8	56.6				
6014441	WB 2D56 WCM. 08	56	40	64	214	112	144	70	0.5	57				
6014442	WB 2D57 WCM. 08	57	40	64	216	114	146	70	0.3	57.6				
6014443	WB 2D58 WCM. 08	58	40	64	218	116	148	70	0	58				
6014444	WB 2D59 WCM. 08	59	40	64	220	118	150	70	0	59				
6014445	WB 2D60 WCM. 08	60	40	64	222	120	152	70	0	60				

Kompatibel mit ISO Wendeplatten. / Compatible with ISO inserts.

WB 3D16 WCM

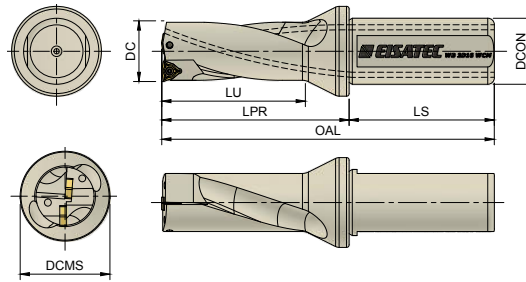

Bohrtiefe bis 3xD
Drilling depth up to 3xD

Mit Innenkühlung
With internal cooling

Artikelnummer Product Code	Bezeichnung Product Name	Abmessungen (mm) Dimensions (mm)							Max. Offset (radial)		Wendeschneidplatte Insert	Klemmschraube Screw	Torx-Schlüssel Torx Key			
		DC	DCON	DCMS	OAL	LU	LPR	LS	Xmax (mm)	DC max (mm)						
6014447	WB 3D16 WCM. 03	16	25	34	126	48	70	56	1.5	19	WCM. 030208	6211333				
6014448	WB 3D16.5 WCM. 03	16.5	25	34	126	48	70	56		19.5						
6014449	WB 3D17 WCM. 03	17	25	34	129	51	73	56		20						
6014450	WB 3D17.5 WCM. 03	17.5	25	34	129	51	73	56		20.5						
6014451	WB 3D18 WCM. 03	18	25	34	132	54	76	56	1.4	20.8						
6014452	WB 3D18.5 WCM. 03	18.5	25	34	132	54	76	56	1.3	21.1						
6014453	WB 3D19 WCM. 03	19	25	34	135	57	79	56	1.2	21.4						
6014454	WB 3D19.5 WCM. 03	19.5	25	34	135	57	79	56		21.9						
6014455	WB 3D20 WCM. 04	20	25	34	138	60	82	56	1.5	23				WCM. 040208	6211346	6211602
6014456	WB 3D20.5 WCM. 04	20.5	25	34	138	60	82	56		23.5						
6014457	WB 3D21 WCM. 04	21	25	34	141	63	85	56	1	23						
6014458	WB 3D21.5 WCM. 04	21.5	25	34	141	63	85	56		23.5						
6014459	WB 3D22 WCM. 04	22	25	34	144	66	88	56		24						
6014460	WB 3D22.5 WCM. 04	22.5	25	34	144	66	88	56		24.5						
6014461	WB 3D23 WCM. 04	23	25	34	147	69	91	56		25						
6014462	WB 3D23.5 WCM. 04	23.5	25	34	147	69	91	56		25.5						
6014463	WB 3D24 WCM. 05	24	25	34	150	72	94	56		1.4	26.8					
6014464	WB 3D24.5 WCM. 05	24.5	25	34	150	72	94	56			27.3					
6014465	WB 3D25 WCM. 05	25	25	34	153	75	97	56	1.45	27.9	WCM. 050308	6211346				
6014466	WB 3D25.5 WCM. 05	25.5	25	34	153	75	97	56		28.4						
6014467	WB 3D26 WCM. 05	26	25	34	156	78	100	56		28.9						
6014468	WB 3D26.5 WCM. 05	26.5	25	34	156	78	100	56		29.4						
6014469	WB 3D27 WCM. 05	27	25	34	159	81	103	56		29.9						
6014470	WB 3D27.5 WCM. 05	27.5	25	34	159	81	103	56		30.4						
6014471	WB 3D28 WCM. 05	28	25	34	162	84	106	56	1.6	31.2						
6014472	WB 3D28.5 WCM. 05	28.5	25	34	162	84	106	56		31.7						
6014473	WB 3D29 WCM. 05	29	25	34	165	87	109	56	1.65	32.3						
6014474	WB 3D29.5 WCM. 05	29.5	25	34	165	87	109	56		32.8						
6014475	WB 3D30 WCM. 06	30	32	44	177	90	117	60	2.4	34.8	WCM. 06T308	6211362	6211603			
6014508	WB 3D30.5 WCM. 06	30.5	32	44	177	90	117	60		35.3						
6014476	WB 3D31 WCM. 06	31	32	44	180	93	120	60	2.3	35.6						
6014506	WB 3D31.5 WCM. 06	31.5	32	44	180	93	120	60		36.1						
6014477	WB 3D32 WCM. 06	32	32	44	183	96	123	60	2.1	36.2						
6014509	WB 3D32.5 WCM. 06	32.5	32	44	183	96	123	60		36.7						
6014478	WB 3D33 WCM. 06	33	32	44	186	99	126	60	1.9	36.8						
6014510	WB 3D33.5 WCM. 06	33.5	32	44	186	99	126	60		37.3						
6014479	WB 3D34 WCM. 06	34	32	44	189	102	129	60		37.8						
6014507	WB 3D34.5 WCM. 06	34.5	32	44	189	102	129	60		38.3						

Kompatibel mit ISO Wendeplatten. / Compatible with ISO inserts.

WB 3D35 WCM

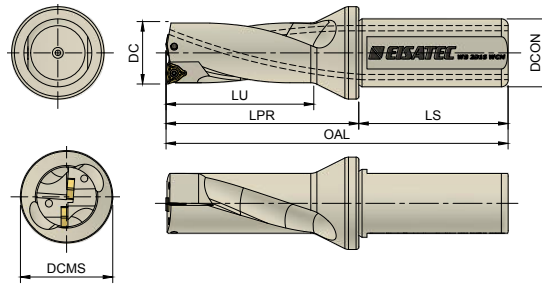

Bohrtiefe bis 3xD

Drilling depth up to 3xD

Mit Innenkühlung
With internal cooling

Artikelnummer Product Code	Bezeichnung Product Name	Abmessungen (mm) Dimensions (mm)								Max. Offset (radial)		Wendeschneidplatte Insert	Klemmschraube Screw	Torx-Schlüssel Torx Key
		DC	DCON	DCMS	OAL	LU	LPR	LS	Xmax (mm)	DC max (mm)				
6014480	WB 3D35 WCM. 06	35	32	44	192	105	132	60	1.9	38.8	WCM. 06T308	6211362	6211603	
6014511	WB 3D35.5 WCM. 06	35.5	32	44	192	105	132	60	1.9	39.3				
6014481	WB 3D36 WCM. 06	36	32	44	195	108	135	60	2	40				
6014512	WB 3D36.5 WCM. 06	36.5	32	44	195	108	135	60	2	40.5				
6014482	WB 3D37 WCM. 06	37	32	44	198	111	138	60	1.8	40.6				
6014513	WB 3D37.5 WCM. 06	37.5	32	44	198	111	138	60	1.8	41.1				
6014483	WB 3D38 WCM. 06	38	32	44	201	114	141	60	1.5	41				
6014514	WB 3D38.5 WCM. 06	38.5	32	44	201	114	141	60	1.5	41.5				
6014484	WB 3D39 WCM. 06	39	32	44	204	117	144	60	1.3	41.6				
6014515	WB 3D39.5 WCM. 06	39.5	32	44	204	117	144	60	1.3	42.1				
6014485	WB 3D40 WCM. 06	40	32	44	207	120	147	60	1	42				
6014517	WB 3D40.5 WCM. 06	40.5	32	44	207	120	147	60	1	42.5				
6014486	WB 3D41 WCM. 06	41	32	44	210	123	150	60	0.8	42.6				
6014516	WB 3D41.5 WCM. 06	41.5	32	44	210	123	150	60	0.8	43.1				
6014487	WB 3D42 WCM. 06	42	32	44	213	126	153	60	0.5	43				
6014519	WB 3D42.5 WCM. 06	42.5	32	44	213	126	153	60	0.5	43.5				
6014488	WB 3D43 WCM. 06	43	32	44	216	129	156	60	0.3	43.6				
6014518	WB 3D43.5 WCM. 06	43.5	32	44	216	129	156	60	0.3	44.1				
6014489	WB 3D44 WCM. 06	44	32	44	219	132	159	60	0	44				
6014520	WB 3D44.5 WCM. 06	44.5	32	44	219	132	159	60	0	44.5				
6014490	WB 3D45 WCM. 08	45	40	54	237	135	167	70	3.3	51.6	WCM. 080412	6211385	6211604	
6014521	WB 3D45.5 WCM. 08	45.5	40	54	237	135	167	70	3.3	52.1				
6014491	WB 3D46 WCM. 08	46	40	54	240	138	170	70	3	52				
6014492	WB 3D47 WCM. 08	47	40	54	243	141	173	70	2.8	52.6				
6014493	WB 3D48 WCM. 08	48	40	54	246	144	176	70	2.5	53				
6014494	WB 3D49 WCM. 08	49	40	54	249	147	179	70	2.2	53.4				
6014495	WB 3D50 WCM. 08	50	40	54	252	150	182	70	2	54				
6014496	WB 3D51 WCM. 08	51	40	54	255	153	185	70	1.8	54.6				
6014497	WB 3D52 WCM. 08	52	40	54	258	156	188	70	1.5	55				
6014498	WB 3D53 WCM. 08	53	40	54	261	159	191	70	1.3	55.6				
6014499	WB 3D54 WCM. 08	54	40	54	264	162	194	70	1	56				
6014500	WB 3D55 WCM. 08	55	40	54	267	165	197	70	0.8	56.6				
6014501	WB 3D56 WCM. 08	56	40	64	270	168	200	70	0.5	57				
6014502	WB 3D57 WCM. 08	57	40	64	273	171	203	70	0.3	57.6				
6014503	WB 3D58 WCM. 08	58	40	64	276	174	206	70	0	58				
6014504	WB 3D59 WCM. 08	59	40	64	279	177	209	70	0	59				
6014505	WB 3D60 WCM. 08	60	40	64	282	180	212	70	0	60				

Kompatibel mit ISO Wendeplatten. / Compatible with ISO inserts.

WB 4D16 WCM

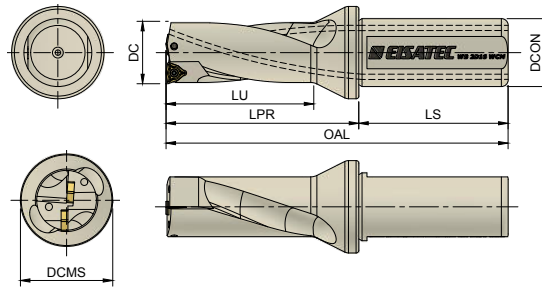

Bohrtiefe bis 4xD
Drilling depth up to 4xD

Mit Innenkühlung
With internal cooling

Artikelnummer Product Code	Bezeichnung Product Name	Abmessungen (mm) Dimensions (mm)								Max. Offset (radial)		Wendeschneidplatte Insert	Klemmschraube Screw	Torx-Schlüssel Torx Key
		DC	DCON	DCMS	OAL	LU	LPR	LS	Xmax (mm)	DC max (mm)				
6014522	WB 4D16 WCM. 03	16	25	34	142	64	86	56	1.5	19	WCM. 030208	6211333	6211602	
6014523	WB 4D16.5 WCM. 03	16.5	25	34	142	64	86	56	1.5	19.5				
6014524	WB 4D17 WCM. 03	17	25	34	146	68	90	56	1.5	20				
6014525	WB 4D17.5 WCM. 03	17.5	25	34	146	68	90	56	1.5	20.5				
6014526	WB 4D18 WCM. 03	18	25	34	150	72	94	56	1.4	20.8				
6014527	WB 4D18.5 WCM. 03	18.5	25	34	150	72	94	56	1.3	21.1				
6014528	WB 4D19 WCM. 03	19	25	34	154	76	98	56	1.2	21.4				
6014529	WB 4D19.5 WCM. 03	19.5	25	34	154	76	98	56	1.2	21.9				
6014530	WB 4D20 WCM. 04	20	25	34	158	80	102	56	1.5	23				
6014531	WB 4D20.5 WCM. 04	20.5	25	34	158	80	102	56	1.5	23.5				
6014532	WB 4D21 WCM. 04	21	25	34	162	84	106	56	1	23	WCM. 040208	6211346	6211602	
6014533	WB 4D21.5 WCM. 04	21.5	25	34	162	84	106	56	1	23.5				
6014534	WB 4D22 WCM. 04	22	25	34	166	88	110	56	1	24				
6014535	WB 4D22.5 WCM. 04	22.5	25	34	166	88	110	56	1	24.5				
6014536	WB 4D23 WCM. 04	23	25	34	170	92	114	56	1	25				
6014537	WB 4D23.5 WCM. 04	23.5	25	34	170	92	114	56	1	25.5				
6014538	WB 4D24 WCM. 05	24	25	34	174	96	118	56	1.4	26.8				
6014539	WB 4D24.5 WCM. 05	24.5	25	34	174	96	118	56	1.4	27.3				
6014540	WB 4D25 WCM. 05	25	25	34	178	122	56	56	1.45	27.9				
6014541	WB 4D25.5 WCM. 05	25.5	25	34	178	122	56	56	1.45	28.4				
6014542	WB 4D26 WCM. 05	26	25	34	182	126	56	56	1.45	28.9				
6014543	WB 4D26.5 WCM. 05	26.5	25	34	182	126	56	56	1.45	29.4				
6014544	WB 4D27 WCM. 05	27	25	34	186	130	56	56	1.45	29.9				
6014545	WB 4D27.5 WCM. 05	27.5	25	34	186	130	56	56	1.45	30.4				
6014546	WB 4D28 WCM. 05	28	25	34	190	134	56	56	1.6	31.2				
6014547	WB 4D28.5 WCM. 05	28.5	25	34	190	134	56	56	1.6	31.7				
6014548	WB 4D29 WCM. 05	29	25	34	194	138	56	56	1.65	32.3				
6014549	WB 4D29.5 WCM. 05	29.5	25	34	194	138	56	56	1.65	32.8				

Kompatibel mit ISO Wendeplatten. / Compatible with ISO inserts.

WB 4D30 WCM

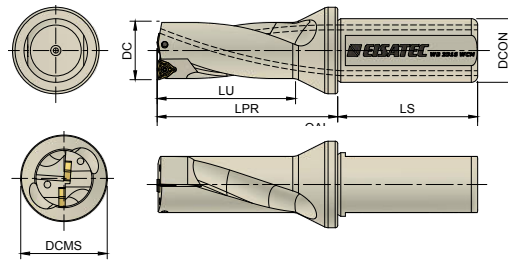

Bohrtiefe bis 4xD

Drilling depth up to 4xD

Mit Innenkühlung
With internal cooling

Artikelnummer Product Code	Bezeichnung Product Name	Abmessungen (mm) Dimensions (mm)								Max. Offset (radial)		Wendeschneidplatte Insert	Klemmschraube Screw	Torx-Schlüssel Torx Key
		DC	DCON	DCMS	OAL	LU	LPR	LS	Xmax (mm)	DC max (mm)				
6014550	WB 4D30 WCM. 06	30	32	44	207	120	147	60	2.4	34.8	WCM. 06T308	6211362	6211603	
6014551	WB 4D31 WCM. 06	31	32	44	211	124	151	60	2.3	35.6				
6014552	WB 4D32 WCM. 06	32	32	44	215	128	155	60	2.1	36.2				
6014553	WB 4D33 WCM. 06	33	32	44	219	132	159	60	1.9	36.8				
6014571	WB 4D33.5 WCM. 06	33.5	32	44	219	132	159	60	1.9	37.3				
6014554	WB 4D34 WCM. 06	34	32	44	223	136	163	60	1.9	37.8				
6014555	WB 4D35 WCM. 06	35	32	44	227	140	167	60	1.9	38.8				
6014556	WB 4D36 WCM. 06	36	32	44	231	144	171	60	2	40				
6014557	WB 4D37 WCM. 06	37	32	44	235	148	175	60	1.8	40.6				
6014558	WB 4D38 WCM. 06	38	32	44	239	152	179	60	1.5	41				
6014572	WB 4D38.5 WCM. 06	38.5	32	44	239	152	179	60	1.5	41.5				
6014559	WB 4D39 WCM. 06	39	32	44	243	156	183	60	1.3	41.6				
6014560	WB 4D40 WCM. 06	40	32	44	247	160	187	60	1	42				
6014561	WB 4D41 WCM. 06	41	32	44	251	164	191	60	0.8	42.6				
6014562	WB 4D42 WCM. 06	42	32	44	255	168	195	60	0.5	43				
6014563	WB 4D43 WCM. 06	43	32	44	259	172	199	60	0.3	43.6				
6014564	WB 4D44 WCM. 06	44	32	44	263	176	203	60	0	44				
6014565	WB 4D45 WCM. 08	45	40	54	282	180	212	70	3.3	51.6	WCM. 080412	6211385	6211604	
6014566	WB 4D46 WCM. 08	46	40	54	286	184	216	70	3	52				
6014567	WB 4D47 WCM. 08	47	40	54	290	188	220	70	2.8	52.6				
6014568	WB 4D48 WCM. 08	48	40	54	294	192	224	70	2.5	53				
6014569	WB 4D49 WCM. 08	49	40	54	298	196	228	70	2.2	53.4				
6014570	WB 4D50 WCM. 08	50	40	54	302	200	232	70	2	54				

Kompatibel mit ISO Wendeplatten. / Compatible with ISO inserts.

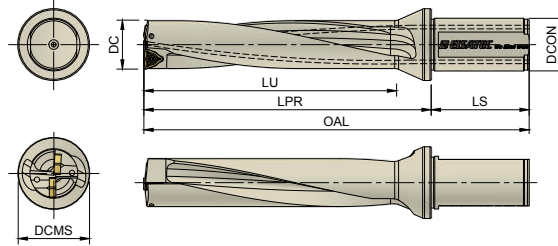

WB 5D20 WCM



Bohrtiefe bis 5xD

Drilling depth up to 5xD

Mit Innenkühlung
With internal cooling

Artikelnummer Product Code	Bezeichnung Product Name	Abmessungen (mm) Dimensions (mm)								Max. Offset (radial)		Wendeschneidplatte Insert	Klemmschraube Screw	Torx-Schlüssel Torx Key
		DC	DCON	DCMS	OAL	LU	LPR	LS	Xmax (mm)	DC max (mm)				
6014573	WB 5D20 WCM. 04	20	25	34	178	100	122	56	1.5	23	WCM. 040208	6211333	6211602	
6014582	WB 5D21 WCM. 04	21	25	34	183	105	127	56	1	23				
6014575	WB 5D22 WCM. 04	22	25	34	188	110	132	56	1	24				
6014574	WB 5D23 WCM. 04	23	25	34	193	115	137	56	1	25	WCM. 050308	6211346	6211602	
6014583	WB 5D24 WCM. 05	24	25	34	198	120	142	56	1.4	26.8				
6014584	WB 5D25 WCM. 05	25	25	34	203	125	147	56	1.45	27.9				
6014576	WB 5D26 WCM. 05	26	25	34	208	130	152	56	1.45	28.9	WCM. 06T308	6211362	6211603	
6014577	WB 5D27 WCM. 05	27	25	34	213	135	157	56	1.45	29.9				
6014585	WB 5D28 WCM. 05	28	25	34	218	140	162	56	1.6	31.2				
6014586	WB 5D29 WCM. 05	29	25	34	223	145	167	56	1.65	32.3	WCM. 080412	6211385	6211604	
6014587	WB 5D30 WCM. 06	30	32	44	237	150	177	60	2.4	34.8				
6014588	WB 5D31 WCM. 06	31	32	44	242	155	182	60	2.3	35.6				
6014589	WB 5D32 WCM. 06	32	32	44	247	160	187	60	2.1	36.2	WCM. 080412	6211385	6211604	
6014578	WB 5D33 WCM. 06	33	32	44	252	165	192	60	1.9	36.8				
6014590	WB 5D34 WCM. 06	34	32	44	257	170	197	60	1.9	37.8				
6014591	WB 5D35 WCM. 06	35	32	44	262	175	202	60	1.9	38.8	WCM. 080412	6211385	6211604	
6014579	WB 5D37 WCM. 06	37	32	44	272	185	212	60	1.8	40.6				
6014580	WB 5D38 WCM. 06	38	32	44	277	190	217	60	1.5	41				
6014581	WB 5D46 WCM. 08	46	40	54	332	230	262	70	3	52	WCM. 080412	6211385	6211604	

Kompatibel mit ISO Wendeplatten. / Compatible with ISO inserts.

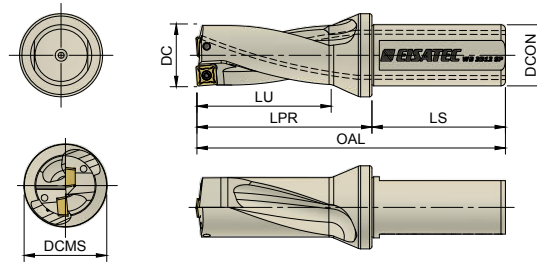

WB 3D12 SP



Bohrtiefe bis 3xD

Drilling depth up to 3xD

Mit Innenkühlung
With internal cooling

Artikelnummer Product Code	Bezeichnung Product Name	Abmessungen (mm) Dimensions (mm)							Max. Offset (radial)		Wendeschneidplatte Insert	Klemmschraube Screw	Torx-Schlüssel Torx Key			
		DC	DCON	DCMS	OAL	LU	LPR	LS	Xmax (mm)	DC max (mm)						
6014781	WB 3D12.5 SP.. 05	12.5	20	25	108	36	58	50	0.75	14	SP.. 050204	6211325	6211600			
6014782	WB 3D13 SP.. 05	13	20	25	111	39	61	50		14.5						
6014783	WB 3D13.5 SP.. 05	13.5	20	25	111	39	61	50		15						
6014784	WB 3D14 SP.. 05	14	20	25	114	42	64	50	0.6	15.2						
6014785	WB 3D14.5 SP.. 05	14.5	20	25	114	42	64	50		15.7						
6014779	WB 3D15 SP.. 05	15	20	25	117	45	67	50	0.5	16						
6014786	WB 3D15.5 SP.. 06	15.5	20	25	117	45	67	50	0.9	17.3				SP.. 060204	6211327	6211601
6014780	WB 3D16 SP.. 06	16	25	34	126	48	70	56	0.8	17.6						
6014787	WB 3D16.5 SP.. 06	16.5	25	34	126	48	70	56		18.1						
6014764	WB 3D17 SP.. 06	17	25	34	129	51	73	56	0.75	18.5						
6014788	WB 3D17.5 SP.. 06	17.5	25	34	129	51	73	56		19						
6014595	WB 3D18 SP.. 06	18	25	34	132	54	76	56	0.5	19.5						
6014790	WB 3D18.5 SP.. 06	18.5	25	34	132	54	76	56		19.6						
6014594	WB 3D19 SP.. 06	19	25	34	135	57	79	56	0.3	20.1						
6014789	WB 3D19.5 SP.. 06	19.5	25	34	135	57	79	56		20						
6014765	WB 3D20 SP.. 06	20	25	34	138	60	82	56	0	20.5						
6014800	WB 3D20.5 SP.. 06	20.5	25	34	138	60	82	56		21						
6014776	WB 3D21 SP.. 06	21	25	34	141	63	85	56		21.5						
6014824	WB 3D21.5 SP.. 06	21.5	25	34	141	63	85	56	1	24	SP.. 07T308	6211333	6211602			
6014766	WB 3D22 SP.. 07	22	25	34	144	66	88	56		23						
6014828	WB 3D22 SP.. 07	22	32	44	153	66	93	60	0.75	24.5						
6014801	WB 3D22.5 SP.. 07	22.5	25	34	144	66	88	56		25						
6014767	WB 3D23 SP.. 07	23	25	34	147	69	91	56	0.5	25						
6014829	WB 3D23 SP.. 07	23	32	44	156	69	96	60								
6014799	WB 3D23.5 SP.. 07	23.5	25	34	147	69	91	56	0.25	25.5						
6014804	WB 3D24 SP.. 07	24	25	34	150	72	94	56								
6014830	WB 3D24 SP.. 07	24	32	44	159	72	99	60	0	26						
6014777	WB 3D24.5 SP.. 07	24.5	25	34	150	72	94	56								
6014768	WB 3D25 SP.. 07	25	25	34	153	75	97	56	0.25	26						
6014831	WB 3D25 SP.. 07	25	32	44	162	75	102	60								
6014794	WB 3D25.5 SP.. 07	25.5	25	34	153	75	97	56	0	26.5						
6014596	WB 3D26 SP.. 07	26	25	34	156	78	100	56								
6014604	WB 3D26 SP.. 07	26	32	44	165	78	105	60								
6014802	WB 3D26.5 SP.. 07	26.5	25	34	156	78	100	56	0	27						
6014597	WB 3D27 SP.. 07	27	25	34	159	81	103	56								
6014605	WB 3D27 SP.. 07	27	32	44	168	81	108	60	0	27.5						
6014601	WB 3D27.5 SP.. 07	27.5	25	34	159	81	103	56								

Kompatibel mit TT Wendepplatten / Compatible with TT inserts.

WB 3D28 SP

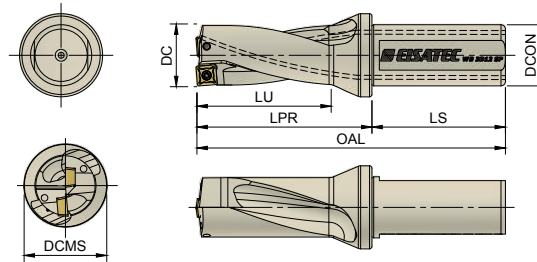

Bohrtiefe bis 3xD
Drilling depth up to 3xD

Mit Innenkühlung
With internal cooling

Artikelnummer Product Code	Bezeichnung Product Name	Abmessungen (mm) Dimensions (mm)							Max. Offset (radial)		Wendeschneidplatte Insert	Klemmschraube Screw	Torx-Schlüssel Torx Key
		DC	DCON	DCMS	OAL	LU	LPR	LS	Xmax (mm)	DC max (mm)			
6014598	WB 3D28 SP.. 09	28	25	34	162	84	106	56	1	30	SP.. 090408	6211365	6211604
6014606	WB 3D28 SP.. 09	28	32	44	171	84	111	60		29			
6014603	WB 3D28.5 SP.. 09	28.5	25	34	162	84	106	56		30.5			
6014600	WB 3D29 SP.. 09	29	25	34	165	87	109	56	0.75	30.5			
6014607	WB 3D29 SP.. 09	29	32	44	174	87	114	6		30.5			
6014602	WB 3D29.5 SP.. 09	29.5	25	34	165	87	109	56	0.5	31			
6014599	WB 3D30 SP.. 09	30	32	44	177	90	117	60		31			
6014808	WB 3D30.5 SP.. 09	30.5	32	44	177	90	117	60	0.25	31.5			
6014778	WB 3D31 SP.. 09	31	32	44	180	93	120	60		31.5			
6014809	WB 3D31.5 SP.. 09	31.5	32	44	180	93	120	60	0	32			
6014769	WB 3D32 SP.. 09	32	32	44	183	96	123	60		32			
6014810	WB 3D32.5 SP.. 09	32.5	32	44	183	96	123	60		32.5			
6014770	WB 3D33 SP.. 09	33	32	44	186	99	126	60		33			
6014811	WB 3D33.5 SP.. 09	33.5	32	44	186	99	126	60	33.5				

Kompatibel mit TT Wendeplatten / Compatible with TT inserts.

Exzenterbuchse
Eccentric Bush

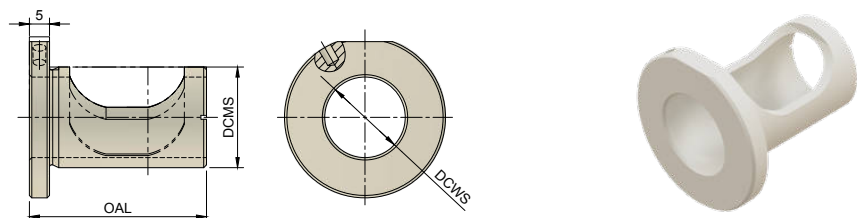

WB 2025

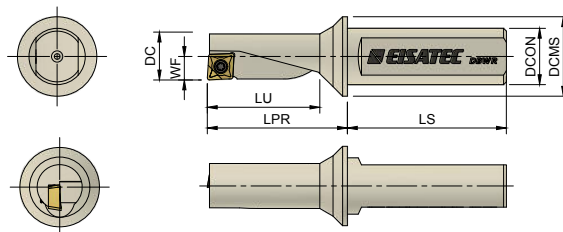

Artikelnummer Product Code	Bezeichnung Product Name	Abmessungen (mm) Dimensions (mm)		
		DCWS	DCMS	OAL
6017541	WB-2025	20	25	44
6017542	WB-2532	25	32	46
6017543	WB-3240	32	40	55

DBWR/L



Artikelnummer Product Code	Bezeichnung Product Name	Abmessungen (mm) Dimensions (mm)								Wendeschneidplatte Insert	Klemmschraube Screw	Torx-Schlüssel Torx Key
		DC	DCON	DCMS	LU	LPR	LS	WF				
6015241	DBWR-D2.25X8 XC.. 040104	8	10	12	18	22	38	4	XC.. 040104	6211321	6211600	
6015243	DBWR-D2.25X10 XC.. 050204	10	12	16	22.5	27.5	42	5	XC.. 050204	6211325		
6015245	DBWR-D2.25X12 XC.. 060204	12	16	20	27	33	45	6	XC.. 060204	6211327	6211601	
6015247	DBWR-D2.25X14 XC.. 070304	14	16	20	31.5	38	45	7	XC.. 070304	6211333	6211602	
6015249	DBWR-D2.25X16 XC.. 080304	16	20	25	36	44	50	8	XC.. 080304	6211344		
6015251	DBWR-D2.25X18 XC.. 09T304	18	25	32	40.5	53.5	56	9	XC.. 09T304		6211365	6211604
6015253	DBWR-D2.25X20 XC.. 10T304	20	25	32	45	55	56	10	XC.. 10T304	6211396	6211605	
6015255	DBWR-D2.25X25 XC.. 130404	25	32	40	56.5	69	60	12.5	XC.. 130404	6211397		
6015257	DBWR-D2.25X32 XC.. 170504	32	32	50	72	88	60	16	XC.. 170504			
6015242	DBWL-D2.25X8 XC.. 040104	8	10	12	18	22	38	4	XC.. 040104	6211321	6211600	
6015244	DBWL-D2.25X10 XC.. 050204	10	12	16	22.5	27.5	42	5	XC.. 050204	6211325		
6015246	DBWL-D2.25X12 XC.. 060204	12	16	20	27	33	45	6	XC.. 060204	6211327	6211601	
6015248	DBWL-D2.25X14 XC.. 070304	14	16	20	31.5	38	45	7	XC.. 070304	6211333	6211602	
6015250	DBWL-D2.25X16 XC.. 080304	16	20	25	36	44	50	8	XC.. 080304	6211344		
6015252	DBWL-D2.25X18 XC.. 09T304	18	25	32	40.5	53.5	56	9	XC.. 09T304		6211365	6211604
6015254	DBWL-D2.25X20 XC.. 10T304	20	25	32	45	55	56	10	XC.. 10T304	6211396	6211605	
6015256	DBWL-D2.25X25 XC.. 130404	25	32	40	56.5	69	60	12.5	XC.. 130404	6211397		
6015258	DBWL-D2.25X32 XC.. 170504	32	32	50	72	88	60	16	XC.. 170504			

Kompatibel mit CR-IS-TT-KR Platten, Compatible with CR-IS-TT-KR Inserts



WENDESCHNEIDPLATTENFRÄSER INDEXABLE MILLS

INDEXABLE MILLS



SCREW-IN MILLING CUTTERS





T-SLOT CUTTERS

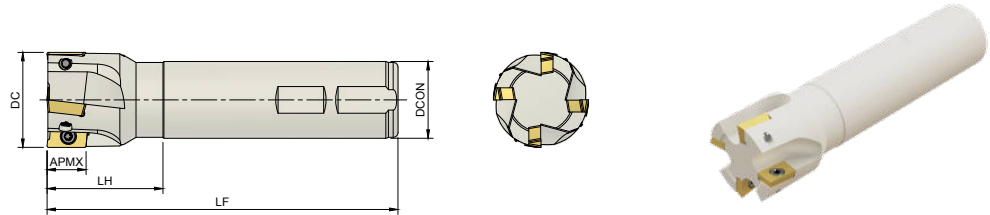

ES90
Anstellwinkel 90°





Artikelnummer Product Code	Bezeichnung Product Name	Abmessungen (mm) Dimensions (mm)						Wendeschneidplatte Insert	Klemmschraube Screw	Torx-Schlüssel Torx Key
		DC	ZEFP	DCON	LF	LH	APMX			
6015497	ES90-AP10-D10-C10-L100-Z01	10	1	10	100	20	10	AP 1003	6211332	6211602
6015498	ES90-AP10-D12-C16-L100-Z01-H	12	1	16	100	30	10			
6015260	ES90-AP10-D12-W16-L100-Z01-H	12	1	16	100	30	10			
6015259	ES90-AP10-D12-W16-L150-Z01	12	1	16	150	38	10			
6015293	ES90-AP10-D14-W16-L100-Z01-H	14	1	16	100	30	10			
6015295	ES90-AP10-D14-W16-L150-Z01	14	1	16	150	38	10			
6015520	ES90-AP10-D16-C16-L100-Z02-H	16	2	16	100	30	10			
6015574	ES90-AP10-D16-W16-L85-Z02-H	16	2	16	85	30	10			
6015261	ES90-AP10-D16-W16-L100-Z02-H	16	2	16	100	30	10			
6015569	ES90-AP10-D16-W16-L150-Z02-H	16	2	16	150	50	10			
6015485	ES90-AP10-D16-W16-L200-Z02	16	2	16	200	100	10			
6015521	ES90-AP10-D16-C16-L120-Z02-H	16	2	16	120	30	10			

Kompatibel mit ISO Wendepplatten / Compatible with ISO inserts

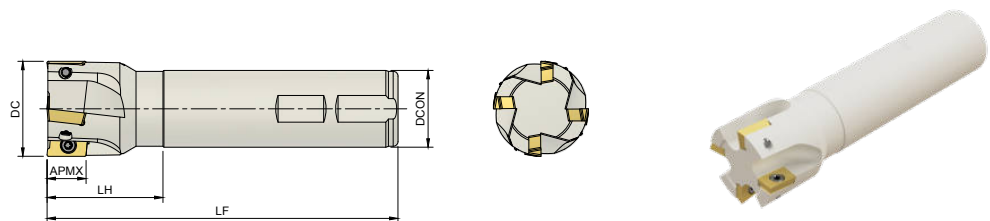
ES90
Anstellwinkel 90°



Artikelnummer Product Code	Bezeichnung Product Name	Abmessungen (mm) Dimensions (mm)						Wendeschneidplatte Insert	Klemmschraube Screw	Torx-Schlüssel Torx Key
		DC	ZEFP	DCON	LF	LH	APMX			
6015538	ES90-AP10-D30-C25-L100-Z04-H	30	4	25	100	30	10	AP 1003	6211333	6211602
6015536	ES90-AP10-D30-C25-L120-Z04-H	30	4	25	120	30	10			
6015540	ES90-AP10-D32-C25-L100-Z04-H	32	4	25	100	35	10			
6015541	ES90-AP10-D32-C25-L120-Z04-H	32	4	25	120	35	10			
6015300	ES90-AP10-D32-C25-L150-Z04	32	4	25	150	35	10			
6015867	ES90-AP10-D32-W25-L105-Z05-H	32	5	25	105	35	10			
6015269	ES90-AP10-D32-W32-L150-Z04	32	4	32	150	50	10			
6015270	ES90-AP10-D40-W32-L150-Z05	40	5	32	150	40	10			

Kompatibel mit ISO Wendepplatten / Compatible with ISO inserts

Anstellwinkel 90°

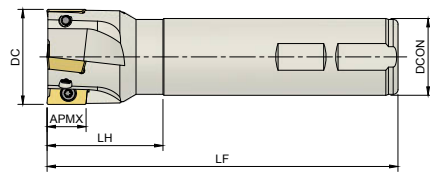



Artikelnummer Product Code	Bezeichnung Product Name	Abmessungen (mm) Dimensions (mm)						Wendeschneidplatte Insert	Klemmschraube Screw	Torx-Schlüssel Torx Key
		DC	ZEFP	DCON	LF	LH	APMX			
6015523	ES90-AP10-D16-C16-L150-Z02	16	2	16	150	50	10	AP 1003	6211332	6211602
6015327	ES90-AP10-D16-C16-L150-Z02-H	16	2	16	150	50	10			
6015262	ES90-AP10-D16-W16-L150-Z02	16	2	16	150	50	10			
6015310	ES90-AP10-D16-C16-L200-Z02	16	2	16	200	100	10			
6015513	ES90-AP10-D16-C16-L200-Z02-H	16	2	16	200	100	10			
6015567	ES90-AP10-D16-C16-L250-Z02	17	2	16	150	30	10			
6015868	ES90-AP10-D17-C16-L150-Z02	17	2	16	250	150	10			
6015294	ES90-AP10-D18-W16-L100-Z02-H	18	2	16	100	30	10			
6015263	ES90-AP10-D18-W16-L150-Z02	18	2	16	150	30	10			
6015866	ES90-AP10-D20-C19-L180-Z02	20	2	19	180	30	10			
6015525	ES90-AP10-D20-C20-L100-Z03-H	20	3	20	100	30	10			
6015852	ES90-AP10-D20-W20-L90-Z03-H	20	3	20	10	30	10			
6015264	ES90-AP10-D20-W20-L100-Z03-H	20	3	20	100	30	10			
6015528	ES90-AP10-D20-C20-L120-Z03-H	20	3	20	120	30	10			
6015530	ES90-AP10-D20-C20-L150-Z03	20	3	20	150	50	10			
6015328	ES90-AP10-D20-C20-L150-Z03-H	20	3	20	150	50	10			
6015265	ES90-AP10-D20-W20-L150-Z03	20	3	20	150	50	10			
6015291	ES90-AP10-D20-C20-L200-Z02	20	2	20	200	100	10			
6015512	ES90-AP10-D20-C20-L200-Z03-H	20	3	20	200	100	10			
6015557	ES90-AP10-D20-C20-L250-Z02	20	2	20	250	150	10			
6015558	ES90-AP10-D20-C20-L250-Z02-H	20	2	20	250	150	10			
6015870	ES90-AP10-D20.5-C20-L90-Z03	20,5	3	20	90	30	10			
6015504	ES90-AP10-D21-C20-L150-Z03	21	3	20	200	35	10			
6018258	ES90-AP10-D21-C20-L200-Z03	21	3	20	200	30	10			
6015503	ES90-AP10-D21-C20-L200-Z03-H	21	3	20	200	35	10			
6015288	ES90-AP10-D21-W20-L150-Z03	21	3	20	150	30	10			
6015266	ES90-AP10-D22-W20-L100-Z03-H	22	3	20	100	30	10			
6015267	ES90-AP10-D22-W20-L150-Z03	22	3	20	150	30	10			
6015545	ES90-AP10-D22.5-W20-L150-Z03	22.5	3	20	150	30	10			
6015544	ES90-AP10-D23-W20-L150-Z03	23	3	20	150	30	10			
6015292	ES90-AP10-D24-W20-L150-Z03	24	3	20	150	30	10			
6015552	ES90-AP10-D25-W25-L100-Z04-H	25	4	25	100	30	10			
6015865	ES90-AP10-D25-W25-L95-Z04-H	25	4	25	95	30	10			
6015570	ES90-AP10-D25-W25-L150-Z04-H	25	4	25	150	50	10			
6015529	ES90-AP10-D25-C25-L100-Z03-H	25	3	25	100	30	10			
6015296	ES90-AP10-D25-W25-L100-Z03-H	25	3	25	100	30	10			
6015532	ES90-AP10-D25-C25-L120-Z03-H	25	3	25	120	30	10			
6015534	ES90-AP10-D25-C25-L150-Z03	25	3	25	150	50	10			
6015268	ES90-AP10-D25-W25-L150-Z03	25	3	25	150	50	10			
6015289	ES90-AP10-D25-C25-L200-Z02	25	2	25	200	100	10			
6015311	ES90-AP10-D25-C25-L200-Z03	25	3	25	200	100	10			
6015299	ES90-AP10-D25-C25-L250-Z02	25	2	25	250	100	10			
6015869	ES90-AP10-D26-C25-L200-Z04	26	4	25	200	35	10			

Kompatibel mit ISO Wendepplatten / Compatible with ISO inserts

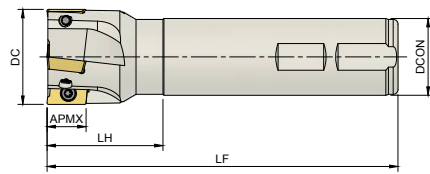

Anstellwinkel 90°

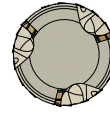
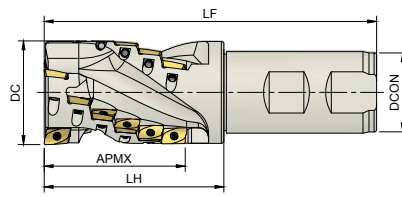

Artikelnummer Product Code	Bezeichnung Product Name	Abmessungen (mm) Dimensions (mm)						Wendeschneidplatte Insert	Klemmschraube Screw	Torx-Schlüssel Torx Key
		DC	ZEFP	DCON	LF	LH	APMX			
6015543	ES90-AP16-D25-C20-L100-Z02	25	2	20	100	35	16	AP 1604	6211384	6211604
6015297	ES90-AP16-D25-W25-L100-Z02-H	25	2	25	100	35	16			
6015275	ES90-AP16-D25-W25-L150-Z02	25	2	25	150	50	16			
6015276	ES90-AP16-D25-C25-L250-Z02	25	2	25	250	100	16			
6015277	ES90-AP16-D28-W25-L100-Z03-H	28	3	25	100	40	16			
6015278	ES90-AP16-D28-W25-L150-Z03	28	3	25	150	40	16			
6015298	ES90-AP16-D30-W25-L110-Z03-H	30	3	25	110	40	16			
6015566	ES90-AP16-D30-W25-L150-Z02	30	2	25	150	40	16			
6015279	ES90-AP16-D30-W25-L150-Z03	30	3	25	150	40	16			
6015280	ES90-AP16-D32-W32-L110-Z03-H	32	3	32	110	40	16			
6015325	ES90-AP16-D32-C32-L150-Z03	32	3	32	150	50	16			
6015313	ES90-AP16-D32-W25-L150-Z03	32	3	25	150	40	16			
6015281	ES90-AP16-D32-W32-L150-Z03	32	3	32	150	50	16			
6015556	ES90-AP16-D32-W32-L150-Z03-H	32	3	32	150	50	16			
6015577	ES90-AP16-D32-C25-L200-Z03-H	32	3	25	200	40	16			
6015282	ES90-AP16-D32-C32-L250-Z02	32	2	32	250	100	16			
6015312	ES90-AP16-D32-C32-L250-Z03	32	3	32	250	100	16			
6015314	ES90-AP16-D35-W32-L150-Z03	35	3	32	150	40	16			
6015283	ES90-AP16-D36-W32-L110-Z03-H	36	3	32	110	40	16			
6015284	ES90-AP16-D36-W32-L150-Z03	36	3	32	150	40	16			
6015285	ES90-AP16-D40-W32-L110-Z04-H	40	4	32	110	40	16			
6015324	ES90-AP16-D40-C32-L150-Z04	40	4	32	150	40	16			
6015286	ES90-AP16-D40-W32-L150-Z04	40	4	32	150	40	16			
6015287	ES90-AP16-D40-C32-L250-Z02	40	2	32	250	40	16			
6015334	ES90-AP16-D40-C32-L250-Z04	40	4	32	250	40	16			

Kompatibel mit ISO Wendepplatten / Compatible with ISO inserts



Artikelnummer Product Code	Bezeichnung Product Name	ZEFP		Abmessungen (mm) Dimensions (mm)					Wendeschneidplatte Insert	Klemmschraube Screw	Torx-Schlüssel Torx Key
		Gesamt Total	Effektiv Effective	DC	DCON	APMX	LH	LF			
6016752	EW90-AP10-D20-W20-L087-Z0204	4	2	20	20	28	37	87	AP 1003	6211333	6211602
6016748	EW90-AP10-D20-W20-L087-Z0206	6		20	20	28	37	87			
6016749	EW90-AP10-D25-W25-L105-Z0208-H	8	2	25	25	37	50	105			
6016750	EW90-AP10-D32-W32-L115-Z0315-H	15	3	32	32	46	55	115			
6016751	EW90-AP10-D40-W32-L130-Z0318-H	18	3	40	32	55	70	130			

Kompatibel mit ISO Wendeplatten / Compatible with ISO inserts.

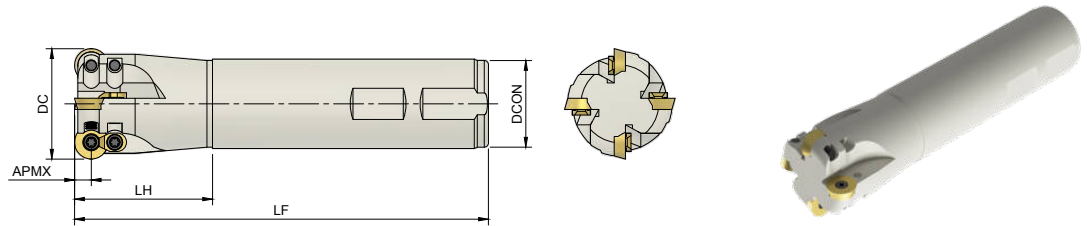

Artikelnummer Product Code	Bezeichnung Product Name	Abmessungen (mm) Dimensions (mm)							Wendeschneidplatte Insert	Klemmschraube Screw	Torx-Schlüssel Torx Key	Befestigungsschraube Mounting Screw	Torx-Schlüssel Torx Key				
		DC	ZEFP	DCON	LF	LH	APMX										
6015379	KS-RD0501-D08-W10-L100-Z01-H	8	1	10	100	20	2.5	RD 0501	6211324								
6015378	KS-RD0501-D10-W12-L100-Z02-H	10	2	12	100	20	2.5										
6015377	KS-RD0501-D12-W12-L120-Z02-H	12	2	12	120	20	2.5	RD 0803	6211344	-	-	6211600					
6015371	KS-RD0803-D16-W16-L150-Z02	16	2	16	150	60	4										
6015372	KS-RD0803-D16-C20-L200-Z02	16	2	20	200	60	4	RD 08T2	6211333			6211602					
6017171	KS-RD0803-D20-W20-L150-Z03	20	3	20	150	60	4										
6015368	KS-RD08T2-D16-W16-L150-Z02	16	2	16	150	60	4	RD 1003									
6015367	KS-RD08T2-D20-W20-L150-Z02	20	2	20	150	60	4										
6015346	KSC-RD1003-D20-W20-L150-Z02	20	2	20	150	60	5										
6015370	KSC-RD1003-D20-C20-L160-Z02	20	2	20	160	70	5										
6015376	KSC-RD1003-D20-C20-L250-Z02	20	2	20	250	150	5										
6015381	KSC-RD1003-D21-C20-L160-Z02	21	2	20	160	70	5										
6015348	KSC-RD1003-D25-W25-L150-Z02	25	2	25	150	60	5										
6015373	KSC-RD1003-D25-C25-L160-Z02	25	2	25	160	70	5										
6015365	KSC-RD1003-D25-W25-L200-Z02	25	2	25	200	100	5										
6015375	KSC-RD1003-D25-C25-L200-Z02	25	2	25	200	100	5										
6015349	KSC-RD1003-D25-C25-L250-Z02	25	2	25	250	150	5										
6015382	KSC-RD1003-D26-C25-L160-Z02	26	2	25	160	70	5										
6015350	KSC-RD1003-D32-W32-L150-Z03	32	3	32	150	60	5										
6015351	KSC-RD1003-D32-C32-L250-Z02	32	2	32	250	150	5										
6015383	KSC-RD1003-D33-C32-L160-Z03	33	3	32	160	70	5										
6015352	KSC-RD1003-D40-W32-L150-Z04	40	4	32	150	35	5										
6015353	KSC-RD1003-D40-C32-L250-Z02	40	2	32	250	50	5										
6015390	KS-RD10T3-D20-C20-L180-Z02-H	20	2	20	180	60	5						RD 10T3	6211365	-	6211365	6211604
6015385	KSC-RD10T3-D20-C20-L150-Z02	20	2	20	150	60	5										
6015354	KSC-RD10T3-D20-W20-L150-Z02	20	2	20	150	60	5										
6015391	KSC-RD10T3-D21-C20-L200-Z02-H	21	2	20	200	80	5										
6015386	KSC-RD10T3-D25-C25-L150-Z02	25	2	25	150	60	5										
6015387	KSC-RD10T3-D25-C25-L200-Z02-H	25	2	25	200	100	5										
6015347	KSC-RD10T3-D25-C32-L150-Z03	25	3	32	150	50	5										
6015355	KSC-RD10T3-D25-W25-L150-Z02	25	2	25	150	60	5										
6015392	KSC-RD10T3-D26-C25-L200-Z02-H	26	2	25	200	35	5										
6015388	KSC-RD10T3-D32-C25-L250-Z03-H	32	3	25	250	35	5										
6015356	KSC-RD10T3-D32-W32-L150-Z03	32	3	32	150	60	5	RD 12T3	6211133	6211367							
6015374	KSC-RD10T3-D32-C32-L150-Z04	32	4	32	150	60	5										
6015357	KSC-RD12T3-D25-W25-L150-Z02	25	2	25	150	60	6										
6015366	KSC-RD12T3-D25-W25-L200-Z02	25	2	25	200	100	6										
6015358	KSC-RD12T3-D25-C25-L250-Z02	25	2	25	250	150	6										
6015364	KSC-RD12T3-D25-C25-L300-Z02	25	2	25	300	200	6										
6015359	KSC-RD12T3-D32-W32-L150-Z03	32	3	32	150	60	6										
6015360	KSC-RD12T3-D32-C32-L250-Z02	32	2	32	250	150	6						RD 1204	6211367			
6015361	KSC-RD12T3-D40-W32-L150-Z04	40	4	32	150	50	6										
6015362	KSC-RD12T3-D40-C32-L250-Z02	40	2	32	250	50	6										
6015369	KSC-RD1204-D32-C32-L160-Z03	32	3	32	160	70	6										
6015380	KSC-RD1204-D32-W32-L160-Z03	32	3	32	160	70	6	RD 1604	6211385	6211125	6211385						
6015384	KSC-RD1204-D33-C32-L160-Z03	33	3	32	160	70	6										
6015389	KSC-RD1204-D32-C32-L160-Z03-H	32	3	32	160	70	6										
6015363	KSC-RD1604-D40-W32-L150-Z02	40	2	32	150	35	8										

Kompatibel mit ISO Wendeplatten / Compatible with ISO inserts.

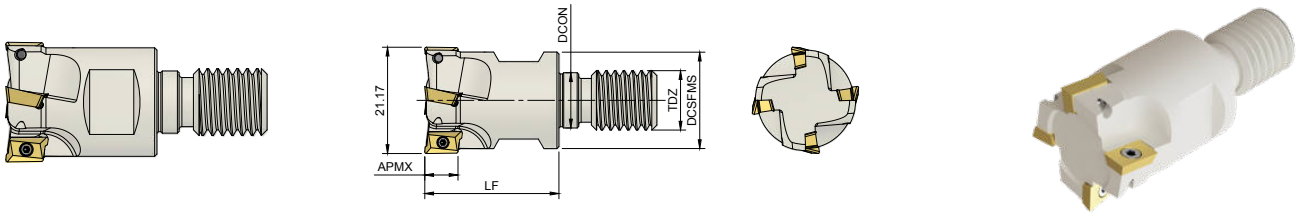

Artikelnummer Product Code	Bezeichnung Product Name	Abmessungen (mm) Dimensions (mm)						Wendeschneidplatte Insert	Klemmschraube Screw	Torx-Schlüssel Torx Key
		DC	ZEFP	TDZ	LF	DCON	APMX			
6017111	ES90-AP10-D16-M08-L30-Z02-H	16	2	14.75	M08	30	8.5	AP 1003	6211333	6211602
6017110	ES90-AP10-D20-M10-L30-Z03-H	20	3	18	M10	30	10.5			
6017108	ES90-AP10-D25-M12-L35-Z03-H	25	3	21	M12	35	12.5			
6017113	ES90-AP10-D32-M16-L35-Z04-H	32	4	29	M16	35	17			
6017128	ES90-AP10-D32-M16-L40-Z04-H	32	4	29	M16	40	17			
6017112	ES90-AP10-D40-M16-L43-Z05-H	40	5	29	M16	43	17			
6017109	ES90-AP10-D42-M16-L43-Z05-H	42	5	29	M16	43	17	AP 1604	6211384	6211604
6017107	ES90-AP16-D25-M12-L43-Z02-H	25	2	21	M12	43	12.5			
6017106	ES90-AP16-D32-M16-L43-Z03-H	32	3	29	M16	43	17			
6017105	ES90-AP16-D40-M16-L43-Z04-H	40	4	29	M16	43	17			
6017122	ES90-AP16-D42-M16-L43-Z04-H	42	4	29	M16	43	17			

Kompatibel mit ISO Wendepplatten / Compatible with ISO inserts

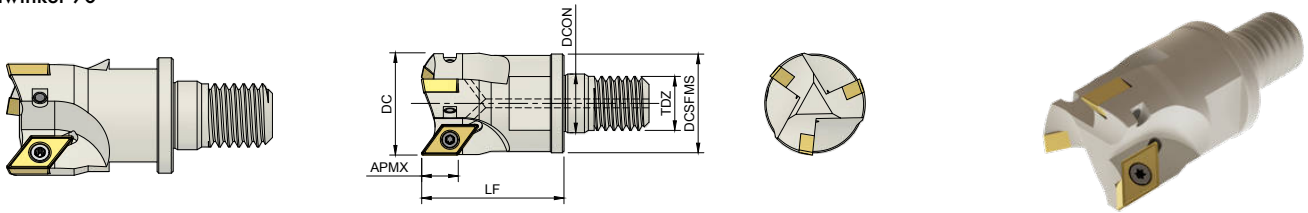

Anstellwinkel 90°

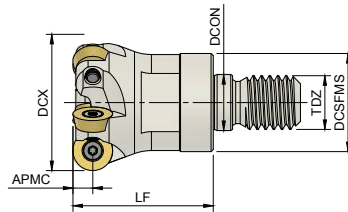
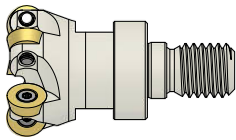

Artikelnummer Product Code	Bezeichnung Product Name	Abmessungen (mm) Dimensions (mm)						Wendeschneidplatte Insert	Klemmschraube Screw	Torx-Schlüssel Torx Key
		DC	ZEFP	DCSFMS	TDZ	LF	DCON			
6017234	ES90-DC07-D20-M10-L30-Z02-H	20	2	18	M10	30	10.5	DC.T 0702	6211333	6211602
6017235	ES90-DC07-D25-M12-L35-Z03-H	25	3	21	M12	35	12.5			
6017236	ES90-DC07-D32-M16-L43-Z04-H	32	4	29	M16	43	17			
6017237	ES90-DC07-D40-M16-L43-Z05-H	40	5	29	M16	43	17	DC.T 11T3	6211365	6211604
6017239	ES90-DC11-D32-M16-L43-Z03-H-F	32	3	29	M16	43	17			
6017238	ES90-DC11-D40-M16-L43-Z03-H-F	40	3	29	M16	43	17			

-F: Axial and Radial Runout Value AS Within 0,02 mm. / F: der Axiale und Radiale Rundlaufwert Liegt Innerhalb von 0,02 mm.
-Kompatibel Mit ISO Wendepplatten / Compatible With ISO Inserts



Artikelnummer Product Code	Bezeichnung Product Name	Abmessungen (mm) Dimensions (mm)							Wendeschneidplatte Insert	Klemmschraube Screw	Torx-Schlüssel Torx Key					
		DC	ZEFP	DCSFMS	TDZ	LF	DCON	APMX								
6017150	KSA-RD0702-D15-M08-L23-Z02-H	15	2	13	M08	23	8.5	3.5	RD 0702	6211333	6211602					
6017135	KSA-RD0702-D16-M08-L23-Z02-H	16	2	14.75	M08	23	8.5	3.5								
6017155	KSA-RD0702-D20-M10-L30-Z04-H	20	4	18	M10	30	10.5	3.5								
6017154	KSA-RD0702-D25-M12-L35-Z05-H	25	5	21	M12	35	12.5	3.5								
6017153	KSA-RD0702-D30-M16-L42-Z05-H	30	5	29	M16	42	17	3.5								
6017134	KSA-RD0702-D32-M16-L43-Z05-H	32	5	29	M16	43	17	3.5								
6017152	KSA-RD0702-D35-M16-L42-Z06-H	35	6	29	M16	42	17	3.5								
6017156	KSA-RD0702-D42-M16-L43-Z05-H	42	5	29	M16	43	17	3.5								
6017157	KSA-RD0702-D42-M16-L43-Z07-H	42	7	29	M16	43	17	3.5								
6017163	KSA-RD08T2-D16-M08-L23-Z02-H	16	2	13	M08	23	8.5	4				RD 08T2	6211333	6211602		
6017169	KSA-RD08T2-D16-M10-L23-Z02-H	16	2	13	M10	23	8.5	4								
6017160	KSA-RD08T2-D20-M10-L30-Z03-H	20	3	18	M10	30	10.5	4								
6017159	KSA-RD08T2-D25-M12-L35-Z04-H	25	4	21	M12	35	12.5	4								
6017164	KSA-RD0802-D16-M08-L23-Z02-H	16	2	13	M08	23	8.5	4							RD 0802	6211344
6017162	KSA-RD0803-D16-M08-L23-Z02-H	16	2	13	M08	23	8.5	4								
6017161	KSA-RD0803-D20-M10-L30-Z03-H	20	3	18	M10	30	10.5	4	RD 0803	6211346						
6017158	KSA-RD0803-D25-M12-L35-Z04-H	25	4	21	M12	35	12.5	4								
6017149	KSA-RD1003-D20-M10-L30-Z02-H	20	2	18	M10	30	10.5	5	RD 1003	6211365	6211604					
6017151	KSA-RD1003-D25-M12-L35-Z02-H	25	2	21	M12	35	12.5	5								
6017131	KSA-RD1003-D25-M12-L35-Z03-H	25	3	21	M12	35	12.5	5								
6017148	KSA-RD1003-D30-M16-L43-Z04-H	30	4	29	M16	43	17	5								
6017132	KSA-RD1003-D32-M16-L43-Z04-H	32	4	29	M16	43	17	5								
6017145	KSA-RD1003-D35-M16-L43-Z04-H	35	4	29	M16	43	17	5								
6017143	KSA-RD1003-D40-M16-L43-Z05-H	40	5	29	M16	43	17	5								
6017133	KSA-RD1003-D42-M16-L43-Z05-H	42	5	29	M16	43	17	5								
6017174	KSA-RD10T3-D25-M12-L35-Z03-H	25	3	21	M12	35	12.5	5	RD 10T3	6211365						
6017175	KSA-RD10T3-D32-M16-L45-Z04-H	32	4	29	M16	45	17	5								
6017181	KSA-RD10T3-D35-M16-L43-Z04-H	35	4	29	M16	43	17	5								
6017178	KSA-RD10T3-D42-M16-L43-Z05-H	42	5	29	M16	43	17	5								
6017172	KSA-RD1004-D25-M12-L35-Z03-H	25	3	21	M12	35	12.5	5	RD 1004	6211382						
6017173	KSA-RD1004-D32-M16-L43-Z04-H	32	4	29	M16	43	17	5								
6017167	KSA-RD1004-D42-M16-L43-Z05-H	42	5	29	M16	43	17	5								
6017147	KSA-RD12T3-D24-M12-L35-Z02-H	24	2	21	M12	35	12.5	6	RD 12T3	6211365	6211604					
6017146	KSA-RD12T3-D25-M12-L35-Z02-H	25	2	21	M12	35	12.5	6								
6017144	KSA-RD12T3-D32-M16-L43-Z03-H	32	3	29	M16	43	17	6								
6017141	KSA-RD12T3-D35-M16-L43-Z03-H	35	3	29	M16	43	17	6								
6017142	KSA-RD12T3-D35-M16-L43-Z04-H	35	4	29	M16	43	17	6								
6017140	KSA-RD12T3-D40-M16-L43-Z04-H	40	4	29	M16	43	17	6								
6017137	KSA-RD12T3-D42-M16-L43-Z05-H	42	5	29	M16	43	17	6								
6017179	KSA-RD1204-D25-M12-L35-Z02-H	25	2	21	M12	35	12.5	6				RD 1204	6211391			
6017165	KSA-RD1204-D32-M16-L43-Z03-H	32	3	29	M16	43	17	6								
6017180	KSA-RD1204-D40-M16-L43-Z04-H	40	4	29	M16	43	17	6								
6017166	KSA-RD1204-D42-M16-L43-Z04-H	42	4	29	M16	43	17	6								
6017136	KSA-RD1604-D32-M16-L43-Z02-H	32	2	29	M16	43	17	8	RD 1604	6211391						
6017139	KSA-RD1604-D40-M16-L43-Z02-H	40	2	29	M16	43	17	8								
6017138	KSA-RD1604-D42-M16-L43-Z03-H	42	3	29	M16	43	17	8								

Kompatibel mit ISO Wendepplatten / Compatible with ISO inserts

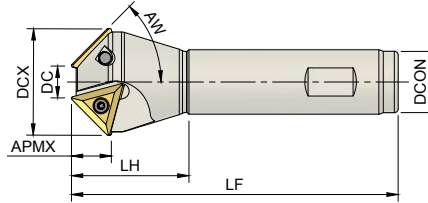
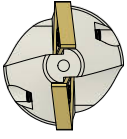

Artikelnummer Product Code	Bezeichnung Product Name	Abmessungen (mm) Dimensions (mm)								Wendeschneidplatte Insert	Klemmschraube Screw	Torx-Schlüssel Torx Key
		AW	DC	DCX	DCON	LF	LH	ZEFP	APMX			
6016733	FF10-TC16-D17X22-W16-L90-Z01	10°	17	22	16	90	30	1	15,2	TC.T 16T304	6211365	6211604
6016734	FF15-TC16-D17X24-W16-L90-Z01	15°	17	24	16	90	30	1	14,9			
6016720	FF15-TC16-D22X29-W16-L100-Z01	15°	22	29	16	100	30	1	14,9			
6016721	FF15-TC16-D30X37-W20-L100-Z02	15°	30	37	20	100	35	2	14,9			
6016722	FF15-TC16-D35X42-W20-L100-Z03	15°	35	42	20	100	38	3	14,9			
6016730	FF15-TC16-D52X59-W25-L110-Z03	15°	52	59	25	110	40	3	14,9			
6016735	FF17.5-TC16-D17X25-W16-L90-Z01	17,5°	17	35	16	90	30	1	14,7			
6016717	FF18.5-TC16-D21.3X30-W20-L100-Z02	18,5°	21,3	30	20	100	30	2	13,5			
6016741	FF20-TC16-D12X22-W16-L100-Z01	20°	12	22	16	100	30	1	14,4			
6016736	FF20-TC16-D17X27-W16-L100-Z01	20°	17	27	16	100	30	1	14,4			
6016723	FF20-TC16-D23X33-W20-L100-Z02	20°	23	33	20	100	30	2	14,4			
6016724	FF20-TC16-D28X38-W20-L100-Z02	20°	28	38	20	100	35	2	14,4			
6016725	FF20-TC16-D35X45-W20-L100-Z03	20°	35	45	20	100	40	3	14,4			
6016726	FF20-TC16-D39X49-W20-L100-Z03	20°	39	49	20	100	40	3	14,4			
6016727	FF20-TC16-D45X55-W25-L110-Z03	20°	45	55	25	110	40	3	14,4			
6016731	FF20-TC16-D51X61-W25-L110-Z03	20°	51	61	25	110	40	3	14,4			
6016710	FF22.5-TC16-D17X28-W16-L100-Z01	22,5°	17	28	16	100	30	1	14,2			
6016706	FF25-TC16-D17X29-W16-L100-Z01	25°	17	29	16	100	30	1	13,9			
6016711	FF30-TC16-D6X20-W16-L100-Z01	30°	6	20	16	100	30	1	13,3			
6016732	FF30-TC16-D15X30-W16-L100-Z01	30°	15	30	16	100	30	1	13,3			
6016719	FF30-TC16-D17.5X32.5-W20-L100-Z02	30°	17,5	32,5	20	100	30	2	13,3			
6016712	FF30-TC16-D20X35-W16-L100-Z02	30°	20	35	16	100	35	2	13,3			
6016713	FF30-TC16-D30X45-W20-L100-Z02	30°	30	45	20	100	40	2	13,3			
6016729	FF30-TC16-D35X50-W20-L100-Z03	30°	35	50	20	100	40	3	13,3			
6016728	FF30-TC16-D45X60-W25-L110-Z03	30°	45	60	25	110	40	3	13,3			
6016709	FF40-TC16-D18X37-W20-L100-Z02	40°	18	37	20	100	40	2	11,7			
6016740	FF45-TC09-D7X18-W16-L100-Z02	45°	7	18	16	100	25	2	5,9	TC.T 090204	6211327	6211601
6016716	FF45-TC11-D11X24-W16-L100-Z02	45°	11	24	16	100	25	2	6,9	TC.T 110204	6211333	6211602
6016743	FF45-TC16-D5X26-W16-L100-Z01	45°	5	26	16	100	30	1	10,8	TC.T 16T304	6211365	6211604
6016737	FF45-TC16-D10X31-W16-L100-Z02	45°	10	31	16	100	35	2	10,8			
6016744	FF45-TC16-D10X31-W20-L100-Z02	45°	10	31	20	100	35	2	10,8			
6016707	FF45-TC16-D18X39-W16-L100-Z02	45°	18	39	16	100	40	2	10,8			
6016742	FF45-TC16-D18X39-W20-L100-Z02	45°	18	39	20	100	40	2	10,8			
6016738	FF45-TC16-D20X41-W20-L100-Z02	45°	20	41	20	100	40	2	10,8			
6016739	FF45-TC16-D30X51-W20-L100-Z02	45°	30	51	20	100	40	2	10,8			
6016708	FF50-TC16-D16X39-W20-L100-Z03	50°	16	39	20	100	40	3	9,8			
6016714	FF55-TC16-D16X40-W20-L100-Z03	55°	16	40	20	100	40	3	8,7			
6016715	FF62-TC16-D14X40-W20-L100-Z03	62°	14	40	20	100	40	3	7,1			
6016718	FF72-TC16-D14X42-W20-L100-Z03	72°	14	42	20	100	40	3	4,6			

Kompatibel mit ISO Wendepplatten. / Compatible with ISO inserts.

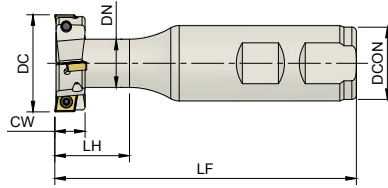
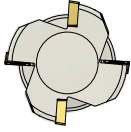

Artikelnummer Product Code	Bezeichnung Product Name	ZEFP		Abmessungen (mm) Dimensions (mm)						Wendeschneidplatte Insert	Klemmschraube Screw	Torx-Schlüssel Torx Key
		Gesamt Total	Effektiv Effective	DC	CW	DCON	LF	DN	LH			
6016666	NF90-CC06-D17X8-W16-L85-Z02	2	1	17	8	16	85	10	16	CC.T 0602	6211333	6211602
6016688	NF90-CC06-D22X8-W20-L83-Z04	4	2	22	8	20	83	9	38			
6016676	NF90-CC06-D32X8-W25-L100-Z04	4	2	32	8	25	100	16	23			
6016683	NF90-CC06-D28X8-W20-L66-Z04	4	2	28	8	20	66	14	15			
6016687	NF90-CC06-D45.5X8-W25-L100-Z06	6	3	45.5	8	25	100	12	30			
6016678	NF90-CC06-D63X8-W32-L125-Z08	8	4	63	8	32	125	31.5	30			
6016680	NF90-CC06-D18X9-W16-L90-Z02	2	1	18	9	16	90	10	16			
6016667	NF90-CC06-D20X9-W16-L85-Z04	4	2	20	9	16	85	10	16			
6016668	NF90-CC06-D23X10-W20-L90-Z04	4	2	23	10	20	90	12	25			
6016677	NF90-CC06-D32X10-W25-L100-Z04	4	2	32	10	25	100	16	25			
6016679	NF90-CC06-D45X10-W32-L120-Z06	6	3	45	10	32	120	20	25			
6016681	NF90-CC06-D25X11-W25-L100-Z04	4	2	25	11	25	100	13	20			
6016669	NF90-CC09-D30X12-W25-L100-Z04	4	2	30	12	25	100	16	25			
6016684	NF90-CC09-D32X12-W25-L100-Z02	2	1	32	12	25	100	16	25			
6016670	NF90-CC09-D32X12-W25-L100-Z04	4	2	32	12	25	100	16	25			
6016682	NF90-CC09-D32X14-W25-L100-Z04	4	2	32	14	25	100	16	25			
6016671	NF90-CC09-D37X16-W32-L120-Z04	4	2	37	16	32	120	17	30			
6016686	NF90-CC09-D40X17-W32-L120-Z04-H	4	2	40	17	32	120	19	30			
6016672	NF90-CC09-D42X17-W32-L120-Z04	4	2	42	17	32	120	19	30			
6016673	NF90-CC12-D47X20-W32-L120-Z04	4	2	47	20	32	120	25	45			
6016674	NF90-CC12-D52X21-W32-L120-Z04	4	2	52	21	32	120	25	45			
6016685	NF90-CC12-D50X22-W32-L120-Z04	4	2	50	22	32	120	25	45			
6016675	NF90-CC12-D55X22-W32-L120-Z04	4	2	55	22	32	120	25	45			

NFR90

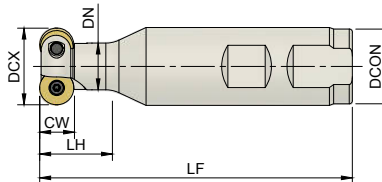

Artikelnummer Product Code	Bezeichnung Product Name	ZEFP	Abmessungen (mm) Dimensions (mm)						Wendeschneidplatte Insert	Klemmschraube Screw	Torx-Schlüssel Torx Key
			DCX	CW	DCON	LF	DN	LH			
6016692	NFR-RD07-D17-W16-L90-Z02	2	17	7	16	90	10	12	RD 0702	6211333	6211602
6016694	NFR-RD07-D25-W16-L90-Z03	3	25	7	16	90	15	12			
6016693	NFR-RD07-D35-W25-L100-Z05	5	35	7	25	100	20	20	RD 1003	6211365	6211604
6016689	NFR-RD10-D21-W25-L100-Z02	2	21	10	25	100	12	20			
6016696	NFR-RD10-D80-W32-L165-Z06-H	6	80	10	32	165	30	31.5			
6016691	NFR-RD12-D25-W25-L100-Z02	2	25	12	25	100	15	24			
6016695	NFR-RD12-D80-W32-L165-Z06-H	6	80	12	32	165	30	31.5			
6016690	NFR-RD16-D34-W32-L110-Z02	2	34	16	32	110	20	30	RD 1604	6211391	



FRÄSERWERKZEUGE MILLING TOOLS

FACE MILLS



HIGH FEED MILLING CUTTERS

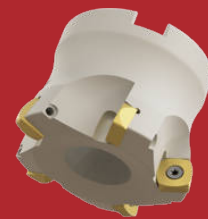





DISC MILLING CUTTERS

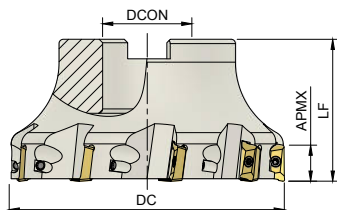
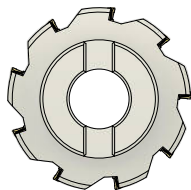

Anstellwinkel 90°



Artikelnummer Product Code	Bezeichnung Product Name	Abmessungen (mm) Dimensions (mm)					Wendeschneidplatte Insert	Klemmschraube Screw	Torx-Schlüssel Torx Key	Befestigungsschraube Mounting Screw
		DC	ZEFP	DCON	LF	APMX				
6016034	PEM90-AP10-D040-A16-Z04-H	40	4	16	35	10		 6211333	 6211602	6211465
6016003	PEM90-AP10-D040-A16-Z05-H	40	5	16	40	10				6211470
6016004	PEM90-AP10-D050-A22-Z06-H	50	6	22	40	10				6211470
6018059	PEM90-AP10-D050-A22-Z07-H	50	7	22	40	10				6211333
6016005	PEM90-AP10-D063-A22-Z06	63	6	22	40	10				6211333
6016006	PEM90-AP10-D063-A22-Z07-H	63	7	22	40	10				6211473
6016014	PEM90-AP10-D063-A22-Z09	63	9	22	40	10				6211474
6016015	PEM90-AP10-D080-A27-Z08-H	80	8	27	50	10				6211465
6016021	PEM90-AP10-D100-A32-Z09-H	100	9	32	50	10				6211470
6016007	PEM90-AP16-D040-A16-Z04-H	40	4	16	40	16				
6016008	PEM90-AP16-D050-A22-Z05-H	50	5	22	40	16	6211474			
6016035	PEM90-AP16-D052-A22-Z05-H	52	5	22	40	16	-			
6016009	PEM90-AP16-D063-A22-Z06-H	63	6	22	40	16				
6016010	PEM90-AP16-D080-A27-Z07-H	80	7	27	50	16				
6016011	PEM90-AP16-D100-A32-Z08-H	100	8	32	50	16				
6016012	PEM90-AP16-D125-B40-Z09	125	9	40	63	16				

Kompatibel mit ISO Wendeplatten. / Compatible with ISO inserts.

Anstellwinkel 90°

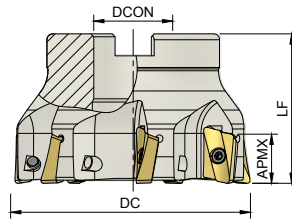
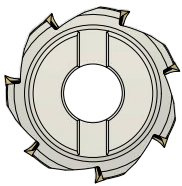

Artikelnummer Product Code	Bezeichnung Product Name	Abmessungen (mm) Dimensions (mm)					Wendeschneidplatte Insert	Klemmschraube Screw	Torx-Schlüssel Torx Key	Befestigungsschraube Mounting Screw			
		DC	ZEFP	DCON	LF	APMX							
6016396	PEM90-BD11T3-D040-A16-Z04-H	40	4	16	40	10	BDMT 11T3	6211333	6211602	6211465			
6016399	PEM90-BD11T3-D040-A16-Z05-H	40	5	16	40	10				BDMT 1704	6211385	6211604	6211470
6016397	PEM90-BD11T3-D050-A22-Z05-H	50	5	22	40	10							6211473
6016398	PEM90-BD11T3-D063-A22-Z06-H	63	6	22	40	10							
6016400	PEM90-BD1704-D050-A22-Z04-H	50	4	22	40	15.7	6211474						
6016393	PEM90-BD1704-D050-A22-Z05-H	50	5	22	40	15.7							
6016394	PEM90-BD1704-D063-A22-Z06-H	63	6	22	40	15.7							
6016401	PEM90-BD1704-D080-A27-Z06-H	80	6	27	50	15.7							
6016395	PEM90-BD1704-D080-A27-Z07-H	80	7	27	50	15.7							
6016402	PEM90-BD1704-D100-A32-Z07-H	100	7	32	50	15.7							

Kompatibel mit KY Wendepplatten. / Compatible with KY Insert.

Anstellwinkel 90°

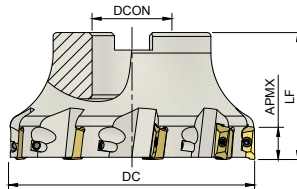
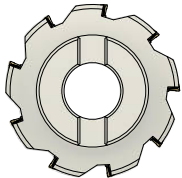

Artikelnummer Product Code	Bezeichnung Product Name	Abmessungen (mm) Dimensions (mm)					Wendeschneidplatte Insert	Klemmschraube Screw	Torx-Schlüssel Torx Key	Befestigungsschraube Mounting Screw			
		DC	ZEFP	DCON	LF	APMX							
6016251	PEM90-R390.11-D040-A16-Z05-H	40	5	16	40	10	R390-11T3	6211333	6211602	6211465			
6016252	PEM90-R390.11-D050-A22-Z06-H	50	6	22	40	10				R390-1704	6211367	6211604	6211470
6016253	PEM90-R390.11-D063-A22-Z07-H	63	7	22	40	10							6211473
6016254	PEM90-R390.11-D080-A27-Z09-H	80	9	27	50	10							
6016245	PEM90-R390.17-D040-A16-Z04-H	40	4	16	40	15.4	R390-1806	6211385	6211604				6211465
6016246	PEM90-R390.17-D050-A22-Z05-H	50	5	22	40	15.4				6211470			
6016247	PEM90-R390.17-D063-A22-Z06-H	63	6	22	40	15.4					6211473		
6016248	PEM90-R390.17-D080-A27-Z07-H	80	7	27	50	15.4							
6016249	PEM90-R390.17-D100-A32-Z08-H	100	8	32	50	15.4				6211474			
6016250	PEM90-R390.17-D125-B40-Z09	125	9	40	63	15.4				-			
6016255	PEM90-R390.18-D050-A22-Z04-H	50	4	22	40	15.4	R390-1806	6211385	6211604	6211470			
6016256	PEM90-R390.18-D063-A22-Z05-H	63	5	22	40	15.4				6211473			
6016257	PEM90-R390.18-D080-A27-Z06-H	80	6	27	50	15.4					6211474		
6016258	PEM90-R390.18-D100-A32-Z07-H	100	7	32	50	15.4							
6016259	PEM90-R390.18-D125-B40-Z08	125	8	40	63	15.4	-						

Kompatibel mit SN Wendepplatten. / Compatible with SN Insert.

Anstellwinkel 90°

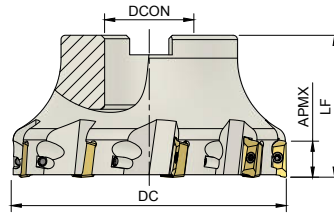
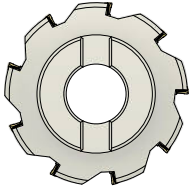

Artikelnummer Product Code	Bezeichnung Product Name	Abmessungen (mm) Dimensions (mm)					Wendeschneidplatte Insert	Klemmschraube Screw	Torx-Schlüssel Torx Key	Befestigungsschraube Mounting Screw
		DC	ZEFP	DCON	LF	APMX				
6016034	PEM90-AP10-D040-A16-Z04-H	40	4	16	35	10	 AP. 1003.. Kompatibel mit ISO Wendeplatten For ISO inserts.	 6211333	 6211602	6211465
6016003	PEM90-AP10-D040-A16-Z05-H	40	5	16	40	10				6211470
6016004	PEM90-AP10-D050-A22-Z06-H	50	6	22	40	10				6211473
6018059	PEM90-AP10-D050-A22-Z07-H	50	7	22	40	10				6211474
6016005	PEM90-AP10-D063-A22-Z06	63	6	22	40	10				-
6016006	PEM90-AP10-D063-A22-Z07-H	63	7	22	40	10				6211470
6016014	PEM90-AP10-D063-A22-Z09	63	9	22	40	10				6211473
6016015	PEM90-AP10-D080-A27-Z08-H	80	8	27	50	10				6211465
6016021	PEM90-AP10-D100-A32-Z09-H	100	9	32	50	10				6211473
6016007	PEM90-AP16-D040-A16-Z04-H	40	4	16	40	16				6211474
6016008	PEM90-AP16-D050-A22-Z05-H	50	5	22	40	16				6211470
6016035	PEM90-AP16-D052-A22-Z05-H	52	5	22	40	16				6211473
6016009	PEM90-AP16-D063-A22-Z06-H	63	6	22	40	16				6211474
6016010	PEM90-AP16-D080-A27-Z07-H	80	7	27	50	16				-
6016011	PEM90-AP16-D100-A32-Z08-H	100	8	32	50	16				6211470
6016012	PEM90-AP16-D125-B40-Z09	125	9	40	63	16	6211473			
6016013	PEM90-AP16-D160-C40-Z10	160	10	40	63	16	6211465			
6016030	PEM90-AP16-D200-C60-Z12	200	12	60	63	16	6211470			
6016036	PEM90-AP16DJ-D050-A22-Z05-H	50	5	22	40	16	6211473			
6016038	PEM90-AP16DJ-D063-A22-Z06-H	63	6	22	40	16	6211470			
6016037	PEM90-AP16DJ-D080-A27-Z07-H	80	7	27	50	16	6211473			
6016033	PEM90-AP16L-D050-A22-Z05-H	50	5	22	40	16	6211470			
6016032	PEM90-AP16L-D063-A22-Z06-H	63	6	22	40	16	6211473			
6016031	PEM90-AP16L-D080-A27-Z07-H	80	7	27	50	16	6211465			
6016020	PEM90-AP16P-D040-A16-Z04-H	40	4	16	40	16	6211470			
6016016	PEM90-AP16P-D050-A22-Z05-H	50	5	22	40	16	6211473			
6016017	PEM90-AP16P-D063-A22-Z06-H	63	6	22	40	16	6211474			
6016018	PEM90-AP16P-D080-A27-Z07-H	80	7	27	50	16	6211470			
6016019	PEM90-AP16P-D100-A32-Z08-H	100	8	32	50	16	6211473			
6016039	PEM90-AP16A-D050-A22-Z05-H	50	5	22	40	15	6211465			
6016040	PEM90-AP16A-D063-A22-Z06-H	63	6	22	40	15	6211470			
6016041	PEM90-AP16A-D080-A27-Z07-H	80	7	27	50	15	6211473			
6016042	PEM90-AP16A-D100-A32-Z08-H	100	8	32	50	15	6211474			
6016043	PEM90-AP16A-D125-B40-Z09	125	9	40	63	15	-			
6016045	PEM90-AP16Y-D040-A16-Z04-H	40	4	16	40	16	6211470			
6016046	PEM90-AP16Y-D050-A22-Z05-H	50	5	22	40	16	6211473			
6016044	PEM90-AP16Y-D063-A22-Z06-H	63	6	22	40	16	6211474			
6016047	PEM90-AP16Y-D080-A27-Z07-H	80	7	27	50	16	6211470			
6016048	PEM90-AP16Y-D100-A32-Z08-H	100	8	32	50	16	6211473			

Anstellwinkel 90°

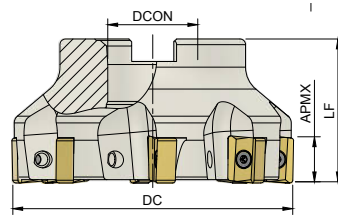
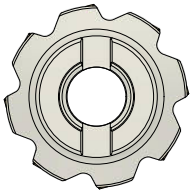

Artikelnummer Product Code	Bezeichnung Product Name	Abmessungen (mm) Dimensions (mm)					Wendeschneidplatte Insert	Klemmschraube Screw	Torx-Schlüssel Torx Key	Befestigungsschraube Mounting Screw			
		DC	ZEFP	DCON	LF	APMX							
6016370	PEM90-AN11-D040-A16-Z04-H	40	4	16	40	11	ANGX 1105	6211349	6211603	6211465			
6016366	PEM90-AN1506-D050-A22-Z04-H	50	4	22	40	14.5				ANGX 1506	6211387	6211604	6211470
6016367	PEM90-AN1506-D063-A22-Z05-H	63	5	22	40	14.5							6211473
6016368	PEM90-AN1506-D080-A27-Z06-H	80	6	27	50	14.5							6211474
6016369	PEM90-AN1506-D100-A32-Z08-H	100	8	32	50	14.5							
6016371	PEM90-AN1506-D125-B40-Z09	125	9	40	63	14.5							

Kompatibel mit ZCC Wendeschneidplatten. / Compatible with ZCC inserts.

Anstellwinkel 90°

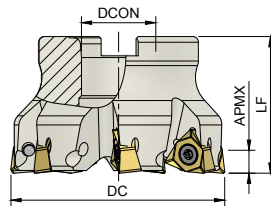
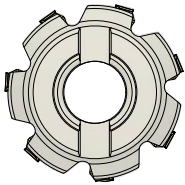

Artikelnummer Product Code	Bezeichnung Product Name	Abmessungen (mm) Dimensions (mm)					Wendeschneidplatte Insert	Klemmschraube Screw	Torx-Schlüssel Torx Key	Befestigungsschraube Mounting Screw			
		DC	ZEFP	DCON	LF	APMX							
6016516	PEM90-WNG04-D040-A16-Z06-H	40	6	16	40	4	WNGU 0403	6211344	6211602	6211465			
6016517	PEM90-WNG04-D050-A22-Z05-H	50	5	22	40	4				WNGU 0806	6211385	6211604	6211470
6016520	PEM90-WNG04-D050-A22-Z07-H	50	7	22	40	4							6211473
6016518	PEM90-WNG04-D063-A22-Z06-H	63	6	22	40	4				6211474			
6016521	PEM90-WNG08-D050-A22-Z05-H	50	5	22	40	7.5							
6016522	PEM90-WNG08-D063-A22-Z06-H	63	6	22	40	7.5							
6016519	PEM90-WNG08-D080-A27-Z07-H	80	7	27	50	7.5							
6016514	PEM90-WNG08-D100-A32-Z07-H	100	10	32	50	7.5							

Kompatibel mit XTC-GSC Wendeschneidplatten. / Compatible with XTC-GSC Inserts.

Anstellwinkel 45°

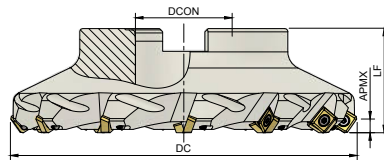
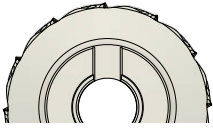

Artikelnummer Product Code	Bezeichnung Product Name	Abmessungen (mm) Dimensions (mm)					Wendeschneidplatte Insert	Klemmschraube Screw	Torx-Schlüssel Torx Key	Befestigungsschraube Mounting Screw
		DC	ZEFP	DCON	LF	APMX				
6015979	PEM45-SE12-D050-A22-Z04-H	50	4	22	40	6	SE 12T3 R245-12T3	6211367	6211604	6211468
6015999	PEM45L-SE12-D050-A22-Z04-H	50	4	22	40	6				
6015980	PEM45-SE12-D063-A22-Z05-H	63	5	22	40	6				
6016001	PEM45L-SE12-D063-A22-Z05-H	63	5	22	40	6				
6015981	PEM45-SE12-D080-A27-Z06-H	80	6	27	50	6				6211473
6016000	PEM45L-SE12-D080-A27-Z06-H	80	6	27	50	6				
6015982	PEM45-SE12-D100-A32-Z07-H	100	7	32	50	6				6211474
6015983	PEM45-SE12-D125-B40-Z08	125	8	40	63	6				
6015984	PEM45-SE12-D160-C40-Z10	160	10	40	63	6				-
6016002	PEM45L-SE12-D160-C40-Z10	160	10	40	63	6				
6015985	PEM45-SE12-D200-C60-Z12	200	12	60	63	6				

Kompatibel mit ZCC-SN Wendepplatten. / Compatible with ZCC-SN Inserts.

Anstellwinkel 45°

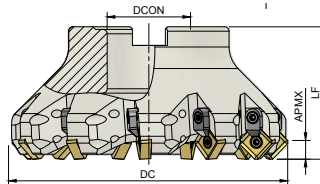
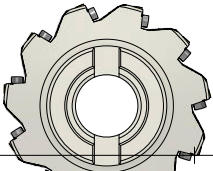

Artikelnummer Product Code	Bezeichnung Product Name	Abmessungen (mm) Dimensions (mm)					Wendeschneidplatte Insert	Klemmschraube Screw	Spannpratze Wedge Clamp	Klemmschraube Clamp Screw	Torx-Schlüssel Torx Key	Befestigungs- Schraube Mounting Screw		
		DC	ZEFP	DCON	LF	APMX								
6016132	PEM45C-SN1206-D050-A22-Z04-H	50	4	22	42	6	SN 1206	6211385	6211125	6211385	6211604			
6016158	PEM45CL-SN1206-D050-A22-Z05-H	50	5	22	42	6								
6016111	PEM45C-SN1206-D050-A22-Z05-H	50	5	22	42	6								
6016133	PEM45C-SN1206-D063-A22-Z06-H	63	6	22	42	6						6211468		
6016112	PEM45C-SN1206-D063-A22-Z07-H	63	7	22	42	6								
6016130	PEM45CL-SN1206-D063-A22-Z07-H	63	7	22	42	6								
6016134	PEM45C-SN1206-D080-A27-Z07-H	80	7	27	52	6						6211473		
6016113	PEM45C-SN1206-D080-A27-Z08-H	80	8	27	52	6								
6016131	PEM45CL-SN1206-D080-A27-Z08-H	80	8	27	52	6						6211474		
6016135	PEM45C-SN1206-D100-A32-Z08-H	100	8	32	52	6								
6016114	PEM45C-SN1206-D100-A32-Z10-H	100	10	32	52	6						6211373		
6016121	PEM45CL-SN1206-D100-A32-Z10-H	100	10	32	52	6								
6016115	PEM45C-SN1206-D125-B40-Z11	125	11	40	65	6								
6016122	PEM45CL-SN1206-D125-B40-Z11	125	11	40	65	6								
6016116	PEM45C-SN1206-D160-C40-Z12	160	12	40	65	6								
6016180	PEM45CL-SN1206-D160-C40-Z12	160	12	40	65	6								
6016117	PEM45C-SN1206-D200-C60-Z14	200	14	60	65	6								
6016128	PEM45CL-SN1206-D200-C60-Z14	200	14	60	65	6								

Kompatibel mit KR-PL-BL Wendepplatten. / Compatible with KR-PL-BL Inserts.

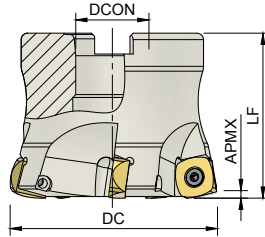
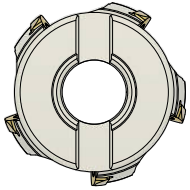



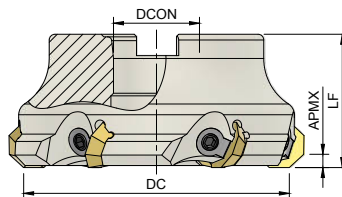
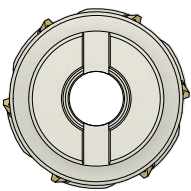

Artikelnummer Product Code	Bezeichnung Product Name	Abmessungen (mm) Dimensions (mm)					Wendeschneidplatte Insert	Klemmschraube Screw	Torx-Schlüssel Torx Key	Befestigungsschraube Mounting Screw
		DC	ZEFP	DCON	LF	APMX				
6016787	PEMH-SD1205-D052-A22-Z04-H	52	4	22	50	2	SD 1205	6211385	6211604	6211470
6016786	PEMH-SD1205-D052-A22-Z05-H	52	5	22	50	2				
6016791	PEMH-SD1205-D063-A22-Z05-H	63	5	22	50	2				
6016790	PEMH-SD1205-D066-A22-Z05-H	66	5	22	50	2				
6016789	PEMH-SD1205-D066-A22-Z06-H	66	6	22	50	2				
6016788	PEMH-SD1205-D080-A27-Z06-H	80	6	27	70	2				6211473

Kompatibel mit HT Wendepplatten. / Compatible with HT inserts.

Anstellwinkel 43°



Artikelnummer Product Code	Bezeichnung Product Name	Abmessungen (mm) Dimensions (mm)					Wendeschneidplatte Insert	Spannpratze Wedge Clamp	Klemmschraube Clamp Screw	Innensechskant- Schlüssel Allen Key	Befestigungsschraube Mounting Screw
		DC	ZEFP	DCON	LF	APMX					
6015967	PEM43C-OF07-D063-A22-Z04	63	4	22	45	5	OF 0704	6211131	6211280	6211588	6211470
6015968	PEM43C-OF07-D080-A27-Z05	80	5	27	50	5					6211473
6015969	PEM43C-OF07-D100-A32-Z06	100	6	32	50	5					6211474
6015970	PEM43C-OF07-D125-B40-Z08	125	8	40	63	5					-
6015971	PEM43C-OF07-D160-C40-Z09	160	9	40	63	5					-

Kompatibel mit ISO Wendepplatten. / Compatible with ISO inserts.

Anstellwinkel 43°

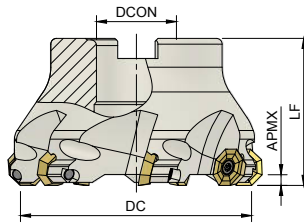
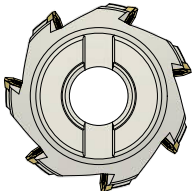

Artikelnummer Product Code	Bezeichnung Product Name	Abmessungen (mm) Dimensions (mm)					Wendeschneidplatte Insert	Klemmschraube Screw	Torx-Schlüssel Torx Key	Befestigungsschraube Mounting Screw
		DC	ZEFP	DCON	LF	APMX				
6016323	PEM43-OF05-D050-A22-Z05-H	50	5	22	40	3	OF 05T3	6211384	6211604	6211468
6016324	PEM43-OF05-D063-A22-Z06-H	63	6	22	40	3		6211385		6211473
6016325	PEM43-OF05-D080-A27-Z07-H	80	7	27	50	3		-		
6016326	PEM43-OF05-D125-B40-Z09	125	9	40	63	3		-		

Kompatibel mit ISO Wendeschneidplatten. / Compatible with ISO inserts.

Anstellwinkel 45°

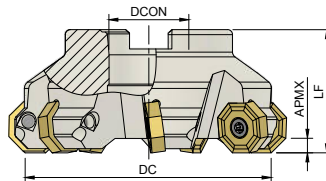
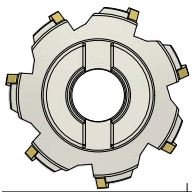

Artikelnummer Product Code	Bezeichnung Product Name	Abmessungen (mm) Dimensions (mm)					Wendeschneidplatte Insert	Klemmschraube Screw	Torx-Schlüssel Torx Key	Befestigungsschraube Mounting Screw
		DC	ZEFP	DCON	LF	APMX				
6016243	PEM45-ON08-D050-A22-Z04-H	50	4	22	40	5.5	ON 0806	6211400	6211605	-
6016215	PEM45-ON08-D063-A22-Z05-H	63	5	22	40	5.5				6211470
6016235	PEM45-ON08-D063-A22-Z06-H	63	6	22	40	5.5				6211473
6016244	PEM45-ON08-D063-A22-Z07-H	63	7	22	40	5.5				
6016214	PEM45-ON08-D080-A27-Z06-H	80	6	27	50	5.5				6211474
6016236	PEM45-ON08-D080-A27-Z08-H	80	8	27	50	5.5				
6016213	PEM45-ON08-D100-A32-Z07-H	100	7	32	50	5.5				
6016226	PEM45-ON08-D100-A32-Z10	100	10	32	50	5.5				
6016238	PEM45-ON08-D100-A32-Z10-H	100	10	32	50	5.5				
6016231	PEM45L-ON08-D100-A32-Z10-H	100	10	32	50	5.5				
6016225	PEM45-ON08-D125-B40-Z08	125	8	40	63	5.5				
6016229	PEM45L-ON08-D125-B40-Z08	125	8	40	63	5.5				
6016227	PEM45-ON08-D125-B40-Z12	125	12	40	63	5.5				
6016216	PEM45-ON08-D160-C40-Z10	160	10	40	63	5.5				
6016228	PEM45-ON08-D160-C40-Z14	160	14	40	63	5.5				
6016217	PEM45-ON08-D200-C60-Z12	200	12	60	63	5.5				
6016242	PEM45-ON08-D250-C60-Z14	250	14	60	63	5.5				
6016224	PEM45-ON08-D315-D60-Z16	315	16	60	63	5.5				

Kompatibel mit ISO Wendeschneidplatten. / Compatible with ISO inserts.

Anstellwinkel 75°

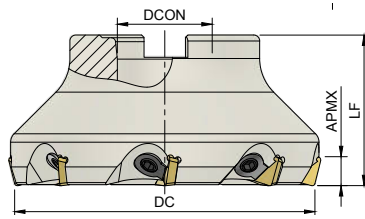
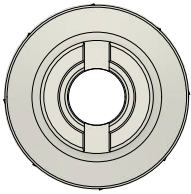

Artikelnummer Product Code	Bezeichnung Product Name	Abmessungen (mm) Dimensions (mm)					Wendeschneidplatte Insert	Spannpratze Wedge Clamp	Klemmschraube Clamp Screw	Innensechskant- Schlüssel Allen Key	Befestigungsschraube Mounting Screw
		DC	ZEFP	DCON	LF	APMX					
6015972	PEM75C-SP12-D050-A22-Z04	50	4	22	42	8	SPKN 1203	6211129	6211276	6211588	6211470
6015973	PEM75C-SP12-D063-A22-Z05	63	5	22	40	8			6211277		6211473
6015974	PEM75C-SP12-D080-A27-Z06	80	6	27	50	8			6211474		
6015975	PEM75C-SP12-D100-A32-Z07	100	7	32	50	8			-		
6015976	PEM75C-SP12-D125-B40-Z08	125	8	40	63	8					
6015977	PEM75C-SP12-D160-C40-Z09	160	9	40	63	8					
6015978	PEM75C-SP12-D200-C60-Z12	200	12	60	63	8					

Kompatibel mit ISO Wendepplatten. / Compatible with ISO inserts.

Anstellwinkel 43°

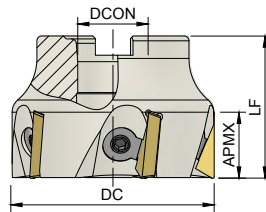
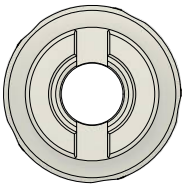

Artikelnummer Product Code	Bezeichnung Product Name	Abmessungen (mm) Dimensions (mm)					Wendeschneidplatte Insert	Spannpratze Wedge Clamp	Klemmschraube Clamp Screw	Innensechskant- Schlüssel Allen Key	Befestigungsschraube Mounting Screw
		DC	ZEFP	DCON	LF	APMX					
6015954	PEM90C-TP16-D050-A22-Z04	50	4	22	40	12	TP 1603	6211129	6211276	6211588	6211468
6015955	PEM90C-TP16-D063-A22-Z06	63	6	22	45	12			6211277		6211470
6015956	PEM90C-TP16-D080-A27-Z07	80	7	27	50	12			6211473		
6015957	PEM90C-TP16-D100-A32-Z08	100	8	32	50	12			6211474		
6015966	PEM90C-TP16-D125-B40-Z08	125	8	40	63	12			-		
6015958	PEM90C-TP22-D063-A22-Z05	63	5	22	45	18			6211470		
6015959	PEM90C-TP22-D080-A27-Z06	80	6	27	50	18			6211473		
6015960	PEM90C-TP22-D100-A32-Z07	100	7	32	50	18	6211474				
6015961	PEM90C-TP22-D125-B40-Z08	125	8	40	63	18	TP 2204	6211131	6211278	6211588	
6015962	PEM90C-TP22-D160-C40-Z09	160	9	40	63	18					
6015963	PEM90C-TP22-D200-C60-Z12	200	12	60	63	18					
6015964	PEM90C-TP22-D250-C60-Z15	250	15	60	63	18					
6015965	PEM90C-TP22-D315-D60-Z18	315	18	60	63	18					

Kompatibel mit ISO Wendepplatten. / Compatible with ISO inserts.

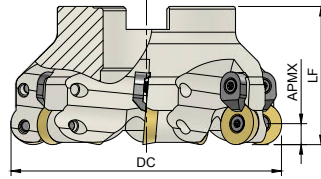
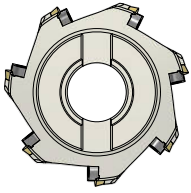



Artikelnummer Product Code	Bezeichnung Product Name	Abmessungen (mm) Dimensions (mm)					Wendeschneidplatte Insert	Klemmschraube Screw	Spannpratze Wedge Clamp	Klemmschraube Clamp Screw	Torx-Schlüssel Torx Key	Befestigungsschraube Mounting Screw			
		DC	ZEFP	DCON	LF	APMX									
6016081	KF-RD0702-D050-A22-Z06-H	50	6	22	40	3.5	RD 0702	6211333	-	-	6211602	6211468			
6016082	KF-RD0803-D050-A22-Z05-H	50	5	22	40	4	RD 0803	6211346	-	-	6211602	6211467			
6016057	KFC-RD1003-D040-A16-Z04-H	40	4	16	40	5	RD 1003	6211367				6211470			
6018238	KF-RD1003-D040-A16-Z05-H	40	5	16	40	5						6211473			
6016058	KFC-RD1003-D050-A22-Z05-H	50	5	22	50	5						6211474			
6016089	KFC-RD1003-D052-A22-Z05	52	5	22	50	5						6211467			
6016059	KFC-RD1003-D063-A22-Z06-H	63	6	22	50	5						6211470			
6016096	KFC-RD1003-D066-A27-Z07-H	66	7	27	50	5						6211473			
6016077	KFC-RD1003-D080-A27-Z07-H	80	7	27	50	5						6211474			
6016078	KFC-RD1003-D100-A32-Z08-H	100	8	32	50	5						6211467			
6016088	KF-RD1004-D063-A22-Z06-H	63	6	22	50	50	RD 1004	6211382	6211133	6211367	6211604	6211467			
6016091	KFC-RD10T3-D040-A16-Z05-H	40	5	16	40	5	RD 10T3	6211365				6211470			
6016092	KFC-RD10T3-D042-A16-Z05-H	42	5	16	40	5						6211473			
6016084	KFC-RD10T3-D050-A22-Z05-H	50	5	22	50	5						6211474			
6016093	KFC-RD10T3-D052-A22-Z05-H	52	5	22	40	5						6211467			
6016094	KFC-RD10T3-D052-A22-Z06-H	52	6	22	40	5	RD 12T3	6211367				6211133	6211367	6211604	6211470
6016085	KFC-RD10T3-D063-A22-Z06-H	63	6	22	50	5									6211467
6018265	KF-RD12T3-D066-A27-Z06-H	66	6	22	50	50									6211470
6016060	KFC-RD12T3-D040-A16-Z04-H	40	4	27	50	6			6211473						
6016061	KFC-RD12T3-D050-A22-Z05-H	50	5	16	40	6			6211474						
6016069	KFC-RD12T3-D052-A22-Z05-H	52	5	22	50	6			-						
6016062	KFC-RD12T3-D063-A22-Z06-H	63	6	22	50	6			6211467						
6016063	KFC-RD12T3-D080-A27-Z07-H	80	7	22	50	6			6211470						
6016064	KFC-RD12T3-D100-A32-Z08-H	100	8	27	50	6	RD 1204	6211367	6211133	6211367	6211604	6211473			
6016065	KFC-RD12T3-D125-B40-Z09	125	9	32	50	6						6211474			
6016066	KFC-RD1204-D040-A16-Z04-H	40	4	40	40	6						-			
6016095	KFC-RD1204-D042-A16-Z04-H	42	4	16	40	6						6211467			
6016076	KFC-RD1204-D050-A22-Z05-H	50	5	16	40	6						6211470			
6016067	KFC-RD1204-D052-A22-Z05-H	52	5	22	50	6						6211473			
6016068	KFC-RD1204-D063-A22-Z06-H	63	6	22	50	6						6211474			
6016074	KFC-RD1204-D080-A27-Z07-H	80	7	22	50	6						6211469			
6016080	KFC-RD1204-D100-A32-Z07-H	100	7	27	50	6	6211470								
6016075	KFC-RD1204-D100-A32-Z08-H	100	8	32	50	6	6211473								
6016079	KFC-RD1604-D050-A22-Z04-H	50	4	32	50	6	RD 1604	6211391	6211125	6211385	6211474				
6016070	KFC-RD1604-D052-A22-Z04-H	52	4	22	50	8					6211470				
6016071	KFC-RD1604-D063-A22-Z05-H	63	5	22	50	8					6211473				
6016086	KFC-RD1604-D066-A22-Z05-H	66	5	22	50	8					6211474				
6016087	KFC-RD1604-D066-A27-Z05-H	66	5	22	50	8					6211469				
6016072	KFC-RD1604-D080-A27-Z06-H	80	6	27	50	8					6211470				
6016073	KFC-RD1604-D100-A32-Z07-H	100	7	27	50	8					6211473				
6016083	KFC-RD1604-D125-B40-Z07	125	7	32	50	8					6211474				
6016090	KFC-RD1604-D160-C40-Z08	160	8	40	63	8					6211469				

Kompatibel mit ISO Wendepplatten. / Compatible with ISO inserts.

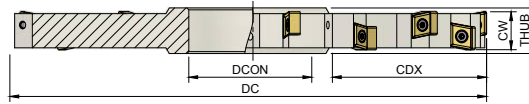
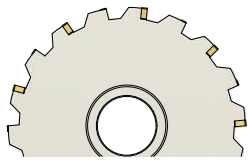







Anstellwinkel 90°





Artikelnummer Product Code	Bezeichnung Product Name	ZEFP		Abmessungen (mm) Dimensions (mm)					Wendeschneidplatte Insert	Klemmschraube Screw	Torx-Schlüssel Torx Key
		Gesamt Total	Effektiv Effective	DC	CW	CDX	DCON	THUB			
6016616	SF- CC06-D80x8-d27-Z10	10	5	80	8	17	27	12	CC.T 0602	6211333	6211602
6016617	SF- CC06-D100x8-d32-Z12	12	6	100	8	25	32	12			
6016618	SF- CC06-D125x8-d40-Z14	14	7	125	8	35	40	12			
6016619	SF- CC06-D160x8-d40-Z16	16	8	160	8	52	40	12			
6016620	SF- CC06-D200x8-d40-Z18	18	9	200	8	70	40	12			
6016621	SF- CC06-D80x10-d27-Z10	10	5	80	10	17	27	14			
6016622	SF-CC06-D100x10-d32-Z12	12	6	100	10	25	32	14			
6016623	SF-CC06-D125x10-d40-Z14	14	7	125	10	35	40	14			
6016624	SF-CC06-D160x10-d40-Z16	16	8	160	10	52	40	14			
6016625	SF-CC06-D200x10-d40-Z18	18	9	200	10	70	40	14			
6016626	SF- CC09-D80x12-d27-Z08	8	4	80	12	17	27	16	CC.T 09T3	6211367	6211604
6016627	SF-CC09-D100x12-d32-Z10	10	5	100	12	25	32	16			
6016628	SF-CC09-D125x12-d40-Z12	12	6	125	12	35	40	16			
6016629	SF-CC09-D160x12-d40-Z14	14	7	160	12	52	40	16			
6016630	SF-CC09-D200x12-d40-Z16	16	8	200	12	70	40	16			
6016631	SF- CC09-D80x14-d27-Z08	8	4	80	14	17	27	18			
6016632	SF-CC09-D100x14-d32-Z10	10	5	100	14	25	32	18			
6016633	SF-CC09-D125x14-d40-Z12	12	6	125	14	35	40	18			
6016634	SF-CC09-D160x14-d40-Z14	14	7	160	14	52	40	18			
6016635	SF-CC09-D200x14-d40-Z16	16	8	200	14	70	40	18			
6016636	SF- CC12-D80x16-d27-Z06	6	3	80	16	17	27	20	CC.T 1204	6211399	6211605
6016637	SF-CC12-D100x16-d32-Z08	8	4	100	16	25	32	20			
6016638	SF-CC12-D125x16-d40-Z10	10	5	125	16	35	40	20			
6016639	SF-CC12-D160x16-d40-Z12	12	6	160	16	52	40	20			
6016640	SF-CC12-D200x16-d40-Z14	14	7	200	16	70	40	20			
6016641	SF- CC12-D80x18-d27-Z06	6	3	80	18	17	27	22			
6016642	SF-CC12-D100x18-d32-Z08	8	4	100	18	25	32	22			
6016643	SF-CC12-D125x18-d40-Z10	10	5	125	18	35	40	22			
6016644	SF-CC12-D160x18-d40-Z12	12	6	160	18	52	40	22			
6016645	SF-CC12-D200x18-d40-Z14	14	7	200	18	70	40	22			
6016646	SF-CC12-D250x18-d40-Z16	16	8	250	18	90	40	22			
6016647	SF- CC12-D80x20-d27-Z06	6	3	80	20	17	27	24			
6016648	SF-CC12-D100x20-d32-Z08	8	4	100	20	25	32	24			
6016649	SF-CC12-D125x20-d40-Z10	10	5	125	20	35	40	24			
6016650	SF-CC12-D160x20-d40-Z12	12	6	160	20	52	40	24			
6016651	SF-CC12-D200x20-d40-Z14	14	7	200	20	70	40	24			
6016652	SF-CC12-D250x20-d40-Z16	16	8	250	20	90	40	24			

Kompatibel mit ISO Wendepplatten. / Compatible with ISO inserts.

Unterlage
Shims

Bild Picture	Artikelnummer Product Code	Bezeichnung Product Name
	6211002	TNGN 16 Unterlage / Shim
	6211002	TNMG 16 Unterlage / Shim
	6211005	TNMG 22 Unterlage / Shim
	6211006	Gewinde 16 Unterlage / for Threading 16 Shim
	6211007	Gewinde 22 Unterlage / for Threading 22 Shim
	6211015	CNMG 09 Unterlage / Shim
	6211018	CNMG 09 Unterlage / Shim
	6211017	CCMT 12 Unterlage / Shim
	6211018	CNGN 12 Unterlage / Shim
	6211019	CNMG 16 Unterlage / Shim
	6211020	CNMG 19 Unterlage / Shim
	6211021	CNMG 25 Unterlage / Shim
	6211024	WNMG 06 Unterlage / Shim
	6211023	WNMG 08 Unterlage / Shim
	6211030	SNMG 09 Unterlage / Shim
	6211031	SCMT 12 Unterlage / Shim
	6211032	SNMG 12 Unterlage / Shim
	6211033	SNMG 15 Unterlage / Shim
	6211034	SNMG 19 Unterlage / Shim
	6211035	SNMG 25 Unterlage / Shim
	6211037	DNMG 11 Unterlage / Shim
	6211038	DNMG 11 Unterlage / Shim
	6211039	DNMG 15 Unterlage / Shim
	6211040	DNMG 15 Dicke Unterlage / Thick Shim
	6211041	VBMT 16, VCMT 16 Unterlage / Shim

Spannspratze
Clamps

Bild Picture	Artikelnummer Product Code	Bezeichnung Product Name
	6211100	DNMG 11, WNMG 06, TNMG 16, CNMG 09 Pratze / Clamp
	6211101	CNMG 12, WNMG 08, TNMG 22, DNMG 15, SNMG 12 Pratze / Clamp
	6211102	VNMG 16 Pratze / Clamp
	6211103	CNMG 16, SNMG 15 Pratze / Clamp
	6211114	WNMG 06 Pratze / Clamp
	6211117	WNMG 08 Pratze / Clamp
	6211118	DNMG 15, TNMG 16-22 Pratze / Clamp
	6211120	TNMG 22 Pratze / Clamp
	6211124	CTFPR Pratze Für Kassette / Cartridge Clamp
	6211123	154.91 Außen-Drehhalter Ø25-Ø32 / External and Internal/ / Pratze / Clamp
	6211125	Zusatzpratze Klein / Additional Small Clamp
	6211129	CNMG 16-19, SNMG 15-19 Zusatzpratze Groß / Additional Big Clamp
	6211133	RD.. 10-12 Pratze / Clamp
	6211131	Ø80-Ø100 TPKN 16-TPKN 22, OFKR 07, HNMX 09 Pratze / Clamp (M8x10)
	6211126	154.91 Innen / Internal Ø16-Ø20 / Pratze / Clamp

Schrauben für Pratzen
Clamp Screws

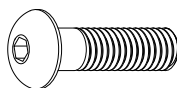

Artikelnummer Product Code	Bezeichnung Product Name	Für For
6211200	M6x1x17 SW3	S20R MT-NR/L 16, S20R-S25S MWLN/R/L 06, S25S MDUNR/L 11- Außen MWLN/R / External 06
6211201	M5x0.8x22 SW3	DNMG 11, WNMG 06, TNMG 16
6211202	M6x1x17 SW4	Is-154.91-R/L-16, Is-154.91-R/L-20, Is-154.91-R/L-25
6211203	M6x1x16 SW3	Is-154.91-R/L-25
6211211	M6x1x22 SW3	AS-154.91, Is-154.91-R/L-32
6211216	M6x1x22 SW3	WNMG 08
6211208	M6x1x22 SW3	Spannpratze / Wedge Clamp
6211213	M6x1x22 SW3	CNMG 12, WNMG 08, TNMG 22, DNMG 15, SNMG 12, VNMG 16 TNMG 16, TNMG 22 2mm Schraube für Außen-Stechwerkzeuge / 2mm External Grooving Tools Screw
6211207	M7X1x25 SW4	CNMG 16, SNMG 15

Klemmschrauben
Clamp Screws

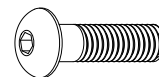

Artikelnummer Product Code	Bezeichnung Product Name
6211241	M8x1x20 SW4

Schrauben für Unterlagen
Shim Screws

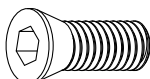

Artikelnummer Product Code	Bezeichnung Product Name	Für For
6211260	M3x0.5x10 SW2 90°	WNMG 06, KNUX 16
6211261	M5x0.8x12 SW3 56°	CNMG 12, WNMG 08, TNMG 22, DNMG 15, SNMG 12
6211262	M6x1x15 SW4 60°	CNMG 16, SNMG 15
6211264	M6x1x16 SW4 76°	CTFPR 13CS 16

Schrauben für Unterlagen
Shim Screws

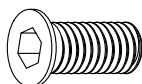

Artikelnummer Product Code	Bezeichnung Product Name	Für For
6211267	M5x0.8x12 SW3 K6	TNMG 16 TNGN 16
6211268	M5x0.8x12 SW3 K6.5	VNMG 16, DNMG 11, CNMG 09

Schrauben für Unterlagen
Shim Screws

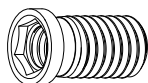

Artikelnummer Product Code	Bezeichnung Product Name	Für For
6211271	M5x0.5x11.3 M3.5x0.6 SW3.5	CCMT 09, DCMT 11, VBMT 16, VCMT 16, TCMT 16, SCMT 09, 16 ER/L, 16 IR/L
6211272	M6x0.75x8 M4.5x0.75 SW4.5	Ø25-Ø32 CCMT 12, Ø25-Ø32 SCMT 12, SSDCN 1616 H12, SSSCR/L 1616 H12, SIR/L S25R 22
6211274	M6x0.75x13 M4.5x0.75 SW4.5	CCMT 12, SCMT 12, 22 ER/L, 22 IR/L
6211273	M5x0.5x8 M3.5x0.6 T20	Ø25 DCMT 11, Ø25-Ø32 CCMT 09, Ø25 TCMT 16, S25S-S32T SVJBR/L 16,

Torx-Schrauben
Torx Screws

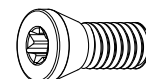

Artikelnummer Product Code	Bezeichnung Product Name
6211320	M1.6x0.35x3.2 T6
6211321	M1.8x0.35x4 T6
6211323	M2x0.4x3.3 T6
6211324	M2x0.4x3.6 T6
6211325	M2x0.4x4.3 T6
6211327	M2.2x0.45x4.6 T7
6211332	M2.5x0.45x5 T8
6211333	M2.5x0.45x6 T8
6211335	M2.5x0.45x4 T8
6211336	M2.5x0.45x4.5 T8
6211337	M2.5x0.45x5.8 T8
6211344	M3x0.5x6 T8
6211346	M3x0.5x8 T8
6211348	M3x0.5x6 T10
6211349	M3x0.5x8 T10
6211350	M3x0.5x8 T8
6211362	M3.5x0.6x9 T10
6211364	M3.5x0.6x7.9 T15
6211365	M3.5x0.6x8.7 T15
6211367	M3.5x0.6x10.7 T15
6211368	M3.5x0.6x12 T15
6211369	M3.5x0.6x13.7 T15
6211373	M4x0.7x10.8 T15
6211375	M4x0.7x11.1 T15
6211382	M4x0.7x8 T15
6211384	M4x0.7x9 T15
6211385	M4x0.7x11 T15
6211387	M4x0.7x12 T15
6211391	M4.5x0.75x11 T15
6211392	M4.5x0.75x14 T20
6211395	M4.5x0.75x16 T20
6211396	M4.5x0.75x10 T20
6211397	M4.5x0.75x12 T20
6211399	M5x0.8x11 T20
6211400	M5x0.8x14.1 T20

Schrauben Für Prätzen
Clamp Screws

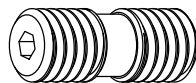

Artikelnummer Product Code	Bezeichnung Product Name	Für For
6211276	M8x1.0x14 SW4	Ø50 TPKN 16
6211277	M8x1.0x16 SW4	SPKN 12, Ø63 TPKN 16
6211278	M8x1.0x18 SW4	Ø80-Ø100 TPKN 16, Ø63-Ø315 TPKN 22
6211280	M8x1.0x20 SW4	OFKR 07, HNMX 09

Schrauben Für Kniehebel
Lever Screws

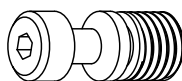

Artikelnummer Product Code	Bezeichnung Product Name	Für For
6211300	M5x0.8x10 SW2.5	TNMG 11
6211301	M6x1x12.6 SW2.5	S16P PCLNR/L 09, S16P PTUNR/L 16
6211302	M6x1x14 SW2.5	S20R PCLNR/L 09, S20R PDUNR/L 11, S20R PDQNR/L 11, S20R PWLNR/L 06, S20R, PTUNR/L 16
6211303	M8x1x16 SW3	S25S PCLNR/L 12, S25S PDUNR/L 15, S25S PSKNR/L 12
6211304	M6x1x17 SW2.5	CNMG 09, DNMG 11, SNMG 09, TNMG 16, WNMG 06
6211305	M8x1x19.8 SW3	CNMG 12, SNMG 12, TNMG 22, WNMG 08, DNMG 15
6211306	M8x1x21.5 SW3	CNMG 16, SNMG 15
6211307	M10x1x27.5 SW4	CNMG 19, SNMG 19
6211308	M12x1x36 SW5	CNMG 25, SNMG 25

Innensechskant-Schrauben
Internal Hex Screws

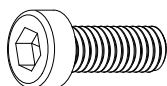

Artikelnummer Product Code	Bezeichnung Product Name
6211450	M4x0.7x10 SW3
6211453	M4x0.7x12 SW3
6211455	M5x0.8x16 SW4
6211456	M5x0.8x12 SW4
6211459	M6x1x 20 SW5
6211460	M6x1x25 SW5
6211461	M6x1x30 SW5
6211465	M8x1.25x30 SW6
6211467	M8x1.25x30 SW6
6211468	M10x1.5x30 SW7
6211469	M10x1.5x30 SW8
6211470	M10x1.5x30 SW8
6211473	M12x1.75x35 SW10
6211474	M16x2.0x35 SW14

Scheibe
Washer

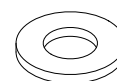

Artikelnummer Product Code	Bezeichnung Product Name
6211540	10.5x6.2x0.5
6211541	12.75x7.1x0.45

Befestigungsfeder
Shim Springs



Artikelnummer Product Code	Bezeichnung Product Name	Für For
6211510	6x4.9x5.6	CNMG 09 ,DNMG 11, SNMG 09, TNMG 16, WNMG 06
6211511	7.9x6.9x6	CNMG 12, SNMG 12, TNMG 22, WNMG 08, DNMG 15
6211512	9.5x8x8.9	CNMG 16, SNMG 15
6211513	10.7x9.8x11	CNMG 19, SNMG 19
6211514	15x13x12	CNMG 25, SNMG 25
6211515	6x4.9x5.6	CNMG 09, TNMG 16

Kniehebel
Lever



Artikelnummer Product Code	Bezeichnung Product Name
6211500	CNMG 09, DNMG 11, SNMG 09, TNMG 16, WNMG 06 Kniehebel / Lever
6211501	CNMG 12, SNMG 12, TNMG 22, WNMG 08 Kniehebel / Lever
6211502	CNMG 16, SNMG 15 Kniehebel / Lever
6211503	CNMG 19, SNMG 19 Kniehebel / Lever
6211504	CNMG 25, SNMG 25 Kniehebel / Lever
6211505	DNMG 15 Kniehebel / Lever
6211506	S16P PCLNR/L 09 Kniehebel / Lever
6211507	S16P PTUNR/L 16 Kniehebel / Lever

Klemmleisten für Stechschwertaufnahme
Blocks for Parting and Deep Grooving Blades



Artikelnummer Product Code	Bezeichnung Product Name
6211570	Klemmeliste SA1 / Block SA1
6211571	Klemmeliste SA2 / Block SA2
6211572	Klemmeliste SA3 / Block SA3
6211573	Klemmeliste SA4 / Block SA4

Innensechskant-Schlüssel
Allen Keys



Artikelnummer Product Code	Bezeichnung Product Name
6211586	2.5 mm Innensechskant-Schlüssel / Allen Key
6211587	3 mm Innensechskant-Schlüssel / Allen Key
6211588	4 mm Innensechskant-Schlüssel / Allen Key
6211589	5 mm Innensechskant-Schlüssel / Allen Key

Sicherungsringe
Retaining Rings



Artikelnummer Product Code	Bezeichnung Product Name
6211576	Sicherungsring 1 / Retaining Ring 1
6211577	Sicherungsring 2 / Retaining Ring 2

Stifte
Pins

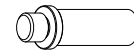

Artikelnummer Product Code	Bezeichnung Product Name	Für For
6211520	3x15.7	154.91
6211521	3.5x12x5x5.4	S25S MWLNR/L 06, Externe / External
6211525	3.55x18x5x6	Internal / Intern Ø32-Ø40 TNMG 16
6211527	5x18x6x7.3	Externe / External TNMG 16
		TNMG 22, WNMG 08

Schwert-Schlüssel
Blade Key

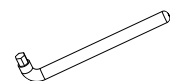

Artikelnummer Product Code	Bezeichnung Product Name
6211580	Schwert-Schlüssel 1 / Blade Key 1
6211581	Schwert-Schlüssel 2 / Blade Key 2
6211582	Schwert-Schlüssel 3 / Blade Key 3

Torx-Schlüssel
Torx Key

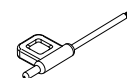

Artikelnummer Product Code	Bezeichnung Product Name
6211600	T06 Torx-Schlüssel / Torx Key
6211601	T07 Torx-Schlüssel / Torx Key
6211602	T08 Torx-Schlüssel / Torx Key
6211603	T10 Torx-Schlüssel / Torx Key
6211604	T15 Torx-Schlüssel / Torx Key
6211605	T20 Torx-Schlüssel / Torx Key



Steinbeisstr. 12
73730 Esslingen am Neckar
Germany

 +49 7124 3849890

info@eisatec.com

www.eisatec.com